

BUYER'S GUIDE

Your Product and Service Headquarters



- 5.11
- BLACKHAWK!
- DYNAMED
- elbeco
- INTEGRAL SERVICES
- ★ PROPPER
- Reebok
- SIGNAL
- STREAMLIGHT
- TRICORP
- UNDER ARMOUR
- vertx

Save Up To **\$500** Per Officer Annually

See page 2 for details

The Authority in Public Safety Equipment and Apparel®

KEEP THIS CATALOG
UNTIL AUGUST 2016



Why Choose a Galls® Customer Website?

Enables you to work together as a unit

- Use your jargon
- Adhere to your product specifications
- Employ your allotment system, whether it be by dollar amount or by unit
- Use uniform programs that contain only preapproved items and uniform customization, restricted by rank and function(s)
- Receive a unique URL secured by unique usernames and passwords

Reduces mistakes and increases effectiveness

- Save time and money (up to \$500 per officer)
- Enjoy easy-to-use interfaces
- Reduce mistakes in ordering
- Allow 24/7 ordering with in-house customization services

Maintains status of team members

- Offer on-demand reporting
- Show real-time availability
- Fully integrate with the warehouse management system
- Manage customer inventory
- Provide command-tree and automated approvals
- Communicate with dashboards and emails

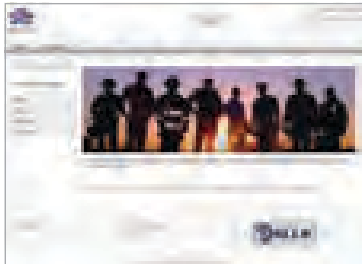

Adapts to changing trends

- Function on your mobile devices
- Access a comprehensive product selection
- Utilize vast sourcing capabilities

Join the thousands of customers

who are already saving time and money with Galls® Customer Websites.

Visit Galls Online Today

Sign up for Galls emails @ galls.com/Pages/EMAIL_SIGNUP and be the first to know about new arrivals and exclusive offers on your favorite brands.



LIKE us on Facebook for the latest in public safety news, products, offers and more @ facebook.com/gallsconnect

galls.com

Price Match Guarantee

We will match the price of an item found on the Internet for a lesser price and currently for sale by Galls. Some restrictions apply.

No Hassle Guarantee

We will repair, replace or refund an order if you are not completely satisfied with a newly purchased item. Some restrictions apply.

Serving Public Safety for Almost 50 Years



Discounts apply to regular priced items only. Prices in this catalog are good through 6/21/16 unless otherwise noted. Some restrictions apply. All promotions are good while supplies last. Percent and dollar-off promotions exclude all products from 5.11 Tactical, Adventure Medical Kits, Aimpoint, Arc'teryx, ASP, ATN, Bates, select Bayco items, Benchmade, Blauer, Cat, Campco, Condor, Danner, Dickies, Dick Kramer, Dutysmith, Elbeco, EOTECH, Force Multiplier, Garmin, GoPro, Granite Gear, Hazard 4, HWI, Intoximeter, Keen, Kelty, Kuhl, LaCrosse, Land Air Sea, Leatherman, Line of Fire, Lowa, Luminox, Magnum, Magpul, Major Surplus, Marmot, Maverick, Maxpedition, Merrell, Mil-Spec Monkey, New Balance, Nike, Oakley, Ogio, Original S.W.A.T., select Pelican items, ProBuilt, select Pro Vision items, Quiqlite, Ridge, select Rocky items, Safariland, Sandpiper, Salomon, Sanmar, Shirt Stays Plus, select Smith & Wesson items, Suunto, Streamlight, Strong Suit, Tasc, Timberland, Thorogood, Tommie Copper, Under Armour, Vertx, Wesol, Whelen and Wolverine, except where otherwise noted.

For our current exclusion list and more information, visit galls.com/PAGES/OFFERDETAILS.



30-Day Footwear Guarantee

If you are not completely satisfied with your footwear within the first 30 days, send them back for a full refund or exchange. For more details, visit galls.com/footwear.



What's Inside?

Page 4 Featured Favorites

Take a look at a few of the products our customers like most, such as the Dyna Med® Kit with C-A-T Tourniquet and ASP® Handcuffs. See p. 4

Page 362 Deals, Deals, Deals

with savings up to 33% off duty gear, range bags, tactical flashlights and more. See p. 362

Starting on Page 13 Product Spotlights

Check out our amazing selection of products, ranging from performance-driven apparel, to fatigue-reducing footwear, to CCW-accessible packs.

Tru-Spec® 24-7 Performance Polo	13
Galls® Tactical Pants	28-29
Tru-Spec® 24-7 Ascent Pants	35
Timberland® Anti-Fatigue Footwear	150-151
Reebok® ZigKick Footwear	182-183
Tru-Spec® TREK Sling Pack	225

FEATURED FAVORITES 4 DEALS, DEALS, DEALS ... 362

PRODUCT SPOTLIGHT

Galls Tactical Pants	28-29
Reebok ZigKick Footwear®	182-183
Timberland Anti-Fatigue Footwear	150-151
TRU-SPEC 24-7 Ascent Pants	35
TRU-SPEC 24-7 Performance Polo	13
TRU-SPEC TREK Sling Pack	225

APPAREL & UNIFORMS

Class C & Casual	6
Bike Apparel	62
Stationwear	66
Class B	76
Class A	84
Specialty Uniforms	92
Uniform Accessories	95
Customization	100
ID & Commendations	106
Outerwear	114
ANSI & Safety	126
Outerwear Accessories	133

FOOTWEAR

Duty	138
Specialty	158
Athletic	168
Accessories	184

TOOLS & EQUIPMENT

Flashlights	188
Traffic Safety	208
Knives & Tools	214
Communications	218
Bags & Organizers	220

FIRST RESPONSE

Medical Kits	230
First Aid Supplies	242
Medical Gloves	248
Turnout & Extrication	250
Bags	251
Fire Boots	252
Rescue Tools	254
Fire & Extrication Gloves	256

VEHICLE

Vehicle Accessories	258
Sirens, Speakers & Switches	264
Warning Lights	276

DUTY GEAR

Nylon	282
Leather & Synthetic	289
Duty Holsters	296
Concealment	301
Accessories	306

LAW & SECURITY

Investigation & Surveillance	308
Restraints	318
Self-Defense	326
Shooting Accessories	336
Tactical & Riot	340
Body Armor	346

ORDERING & SIZING 98

Choose Galls® for Unmatched Customization!



• Uniforms & Gear

Personalize your trousers, shirts, hats and bags according to your department's specifications — regardless of the quantity or intricate details needed. We can outfit your department from head to toe, no matter what the size. Details start on p. 100.

• Badges

Simply select your badge category, model and design, enter your custom information, review your badge and then request a quote. See p. 111 for more information.

• Vehicle Graphics

Galls® is proud to be the industry's leading provider of high quality graphic packages designed specifically for public safety fleets. We offer products to safely and efficiently identify public safety vehicles of all types.

**Call us at
800.477.7766 for
more details**



Take the Next Step in Performance



TRU-SPEC® 24-7
Men's Performance Polo
SR778, p. 12

TRU-SPEC® 24-7
Women's Performance Polo
SR779, p. 12

TRU-SPEC® 24-7
TREK Sling Pack
BB280, p. 225

TRU-SPEC® 24-7
Men's Ascent Pants
TU642, p. 35

TRU-SPEC® 24-7
Women's Ascent Pants
TT724, p. 35

Premium Polos at a Premium Price

Starting at
\$20²⁹

Navy
Plain

Black/White
SECURITY



LawPro® Premium Polo Shirts

Our LawPro Premium Polos have more cotton than a traditional blended fabric. Stay drier, cooler and more comfortable. The extra cotton content provides better breathability and superior moisture wicking.

- Durable 7 oz, 60%, 40% cotton polyester blend
- Generous full-cut sizing gives you more room to move without pulling and pinching
- Welt knit collar and banded cuffs retain their shape
- Designed with a longer back tail to stay tucked in

Sizes: S-6X, see size chart A on p. 98

Plain Shirts: Men's available in all colors.

6R1-SW025 starting at \$20.29+

With POLICE™: available in Black/White, Navy/Gold.

6R1-SW060 starting at \$24.35+

With SECURITY: available in Black/White, Heather Gray/Black, Navy/Gold.

6R1-SW061 starting at \$24.35+

(X) Visit us online for restricted item info.



Performance-Oriented Polos



Short Sleeve
Red



Long Sleeve
Heather Gray

Short Sleeve
Olive Drab



Horace Small™ New Dimension Polos

DRI-Balance® Technology gives superior breathability and absorption. Raglan sleeves, combined with straight side panels, offer an athletic, technical look. This shirt gives you greater freedom of movement, when you need it most.

- Cotton-polyester fabric blend
- DRI-BALANCE® technology
- Superior color retention
- 2 concealed mic pockets at dropped shoulder seams
- Dyed to match rib knit no curl collar with collar stays
- Raglan sleeves and straight side panels
- Heat seal transfer neck label
- Reinforced mic loop at base of placket

Sizes: XS-4X, see size chart B on p. 98

Description	Item	Price
Short Sleeve	6R1-ST115	\$41.99
Long Sleeve	6R1-ST114	\$49.79

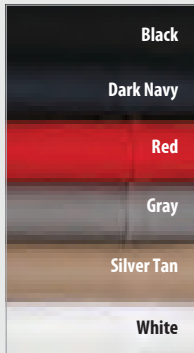

TRU-SPEC® 24-7 Polos

Cotton-polyester pique polo delivers a tailored fit, exceptional comfort and the features you need to do your job.

- Single pique polyester interior with TRU-DRI™ technology creates a soft, comfortable feel that wicks away moisture
- Fade, shrink and wrinkle resistant
- Mic/sunglass loop below placket and dual pen/pencil slot on left sleeve
- No-curl collar

Sizes: Men's and Women's S-4X. See size charts A and E on p. 98

Short Sleeve: Colors: Men's all. Women's Navy, Black, Heather Gray.

Starting at \$29.95+
Men's 6R1-SW750
Women's 6R1-SW991

Long Sleeve: Colors: Men's Navy, Black, Heather Gray, White. Women's Navy, Black, Heather Gray.

Starting at \$34.95+
Men's 6R1-SW859
Women's 6R1-ST110

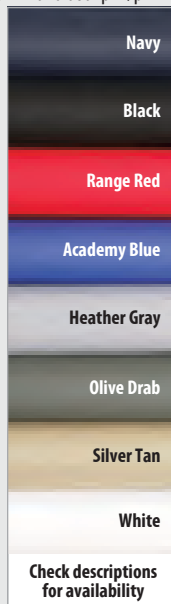

Check descriptions for availability

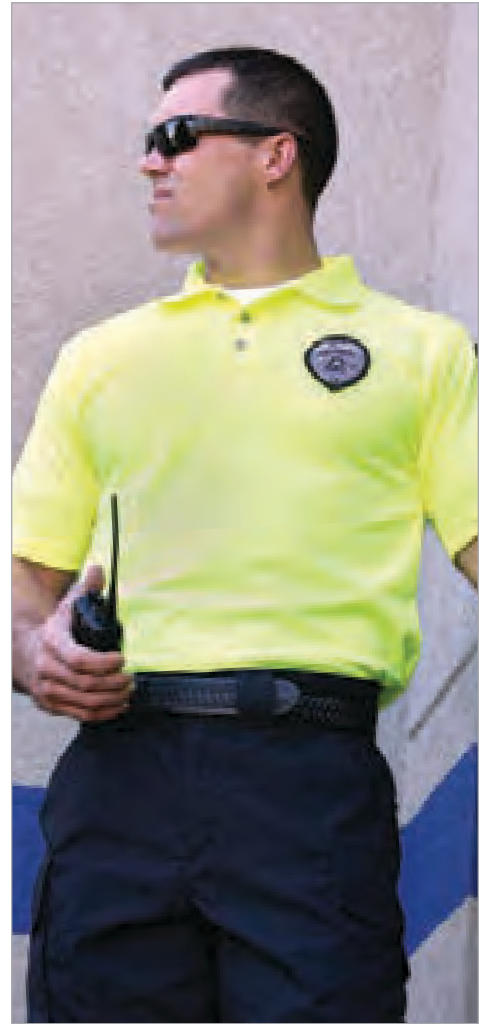

VEA Enhanced Visibility Knit Performance Polo

Stand out with this high visibility and safety polo.

- Polyester performance fabric wicks moisture 3X faster than cotton
- Fabric combats odor
- Rib knit collar for tailored style
- Tri-button placket

Colors: Lime Green, Orange.
Sizes: S-6X, see size chart B on p. 98

6R1-ST510 starting at \$20.99+



Questions?

Our customer service representatives are here to help you Monday-Friday 8:00 a.m. - 9:00 p.m. ET. Call 800.477.7766 today to place an order, ask a question or learn more about our products.

Keep Your Cool in the Heat of Duty

NEW

Men's
Navy



NEW

Women's
Spruce Green



Galls® Tac Force Short Sleeve Polos

A lightweight tactical polo, the Tac Force is perfect for hotter temperatures. Antimicrobial agents fight odor-causing microbes at their onset for fresh, confident wear; and anti-pick fabric prevents snags for a smooth, clean appearance. Raglan sleeves provide an impressive range of motion, with a loose fit for additional comfort.

- 5.6 oz, 100% polyester
- Lightweight
- Antimicrobial to control odor
- Anti-pick to prevent snags
- Pen pocket on shoulder
- Built-in collar stays
- Raglan sleeves for ease of movement
- Front button placket
- Side panel placket
- Locker patch
- Mic tabs
- Loose fit

Sizes: Men's XS-5X. Women's XS-3X, see size charts A and C on p. 98

Description	Item	Price
Men's	6R1-SM616	\$34.99+
Women's	6R1-SM617	\$34.99+

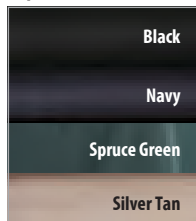

Long Sleeve
Silver Tan



Short Sleeve
LAPD Navy



PROPPER™ I.C.E. Performance Polos

Advanced moisture-wicking fabric pulls moisture away from the body and dries quickly to keep you cool and comfortable.

- Polyester-spandex blend for increased range of motion
- PROPPER I.C.E. (Integrated Cooling Effect) technology is engineered into the fibers so it won't wash out
- Dries 125% faster than cotton and 30% faster than traditional polyester
- Gusseted mesh underarm increases ventilation
- Mic clips on both shoulders and sunglass clip under placket

Colors: (ST136, ST283) all. (ST284) Black, LAPD Navy, Silver Tan, Gray, White. (SM574) Black, Navy. Sizes: Men's XS-5X. Women's S-XL, see size charts A and I on p. 98

Short Sleeve Polos \$34.99

Men's 6R1-ST136
Women's 6R1-ST284

Men's Long Sleeve Polo 6R1-ST283 \$44.99

Women's Long Sleeve Polo 6R1-SM574 \$39.99

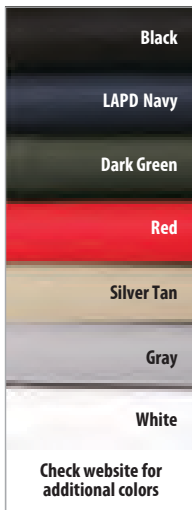

Long Sleeve
Navy



Short Sleeve
Black



TRU-SPEC® 24-7 Performance Polos

Keep your cool even in the heat of duty with polyester jersey knit polos.

- GSA compliant
- No-pick, no-snag technology
- Mil-spec finish controls odors, kills 99% of bacteria in the fabric and protects against 50+ UV rays
- Gusseted short sleeves for excellent range of motion
- Dual pen/pencil slots on left sleeve
- Side vents for increased mobility
- Tri-button placket and mic/sunglass loop below placket

Sizes: Men's XS-5X. Women's S-4X. See size charts A and E on p. 98

Short Sleeve: Colors (SR778) all. (SR779) all except White.

Starting at \$34.95+
Men's 6R1-SR778
Women's 6R1-SR779

Long Sleeve: Colors (ST278) Black, Navy, Red, Steel Gray, Charcoal Gray, Silver Tan. (ST276) Black, Navy, Charcoal Gray, Steel Gray.

Starting at \$39.95+
Men's 6R1-ST278
Women's 6R1-ST276

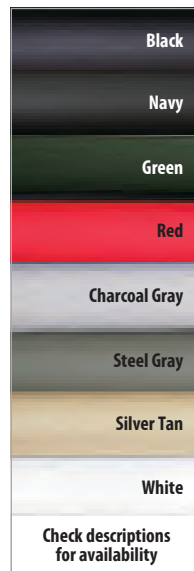

with Polyester Polos



Women's
Blush Red

Men's
Blueprint



Midnight
Navy



OGIO® Linear Polos

A subtle, textured stripe on the Men's Linear Polo conveys individual style, while ruching details give the Ladies Linear Polo a true OGIO look. Both polos come with a strong dose of stretch for easy movement.

- Polyester-spandex fabric blend
- Moisture-wicking technology keeps you cool and dry
- Self-fabric collar
- Double-needle sleeves and hem
- Rubber heat transfer OGIO badge
- OGIO heat transfer label for tag-free comfort

Colors: Men's Blacktop, Cargo Brown, Blueprint, Electric Blue, Fuel Green, Molten Maroon. Women's Blacktop, Blueprint, Electric Blue, Fuel Green, Blush Red. Sizes: Men's and Women's XS-4X. See size charts N and V on p. 99

Starting at **\$35.98+**

Men's **6R1-SG127**

Women's **6R1-SG124**

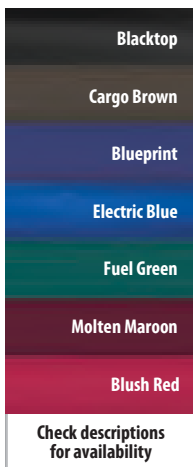

Check descriptions
for availability

[+](#) Visit us online for pricing on additional options.



TACTICAL

Dickies® Tactical Polyester Performance Polo Shirt

Maintain a professional appearance with lightweight fabric that resists wrinkles, fading and shrinkage.

- 4.9 oz, 100% polyester pique
- Moisture wicking
- Fade, shrink and wrinkle resistant
- Pencil pockets
- No roll rib knit collar
- Mesh underarm gusset for ventilation
- Mic clips and sunglass clip
- Drop tail hem helps keep shirt tucked in

Sizes: S-5X, see size chart A on p. 98.

6R1-SG707 \$36.99+



Ordering online? Use your **PROMOTIONAL CODE** from the back cover

800.477.7766 • galls.com

13

Polyester Polos Keep You Looking Sharp



Elbeco™ UFX Tactical Polos

Comfortable, great looking polos are made to stretch in every direction you move.

- Knitted micro-fiber stretch polyester
- Elbeco X-EEDE™ technology wicks away moisture
- Antimicrobial effect inhibits odor at the source
- Fade, shrink, wrinkle and snag resistant
- UPF 40+ ultraviolet protection
- Hidden pen pocket; mic tabs on shoulders and placket

Colors: (SW672) all. (ST120) all colors except Red. (SR585) all colors. (SR459) Black, Dark Navy, Silver Tan, White. (SM541) Navy only. Sizes: Men's S-4X. Women's S-3X. See size charts C and F on p. 98

Starting at \$39.99

Men's **6R1-SW672**

Women's **6R1-ST120**

Men's Long Sleeve 6R1-SR585

starting at \$48.99

Lightweight Short Sleeve: 30% lighter than tactical polo with increased motion, ventilation and flex underarm mesh.

Starting at \$39.99

Men's **6R1-SR459**

Women's **6R1-SM541**

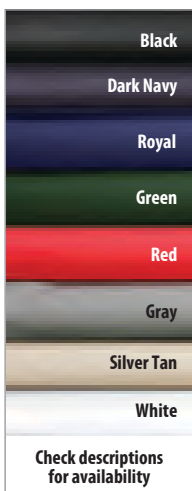

5.11[®]

5.11[®] Performance Polos

These polyester polos from 5.11 are constructed of Smartweave[®], with a high strength-to-weight ratio. Short Sleeve Polo is available in women's sizes, specially engineered to fit a woman's body for a more comfortable and precise fit.

- Moisture wicking
- Antimicrobial effect prevents odor-causing bacteria
- Fade, shrink and wrinkle resistant
- Mic clips on shoulders and a mic clip on the bottom of placket

Sizes: Men's S-3X. Women's S-XL. See size charts A and I on p. 98

Short Sleeve: (SW724) all. (SW993) available in Black, Silver Tan, Dark Navy, White, Range Red.

Starting at \$39.99+

Men's **6R1-SW724**

Women's **6R1-SW993**

Men's Long Sleeve: available in Black, Silver Tan, Dark Navy, TDU Green, White.

6R1-SW726 starting at \$44.99+

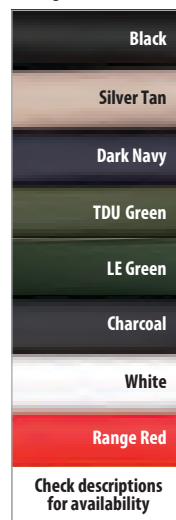

and Feeling Comfortable



Long Sleeve
Black

Short Sleeve
Silver Tan



Men's
Desert Sand

Women's
Dark Navy



Cascade



Vertx® Action Coldblack® Polos

Stay cool with innovative Coldblack® technology. Reflects 80% of the sun's UV rays and lessens the absorption of heat to keep you cool — even while wearing the darkest of colors on the hottest of days.

- 100% antimicrobial polyester pique knit
- Coldblack® finish
- Raglan sleeves
- Side gusset for roomier comfort
- Tri-button placket front with mic tab

Colors: (SW977) All. (SW985) All except Spruce Green and Gray. Sizes: S-4X

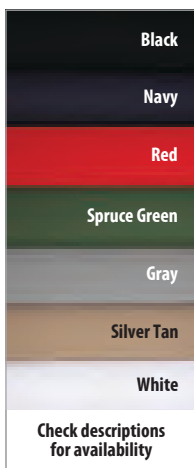

Description	Item	Starting at
Short Sleeve	6R1-SW977	\$46.95+
Long Sleeve	6R1-SW985	\$48.95+

Coldblack® helps you keep your cool in the sun

Dark colors heat up stronger than lighter colors when exposed to direct sunlight. Now there's Coldblack® special finishing technology that reflects up to 80% of the heat rays and has a minimum UPF of 30.

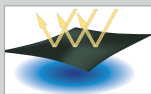

allseasongear™

Under Armour® TAC Range Polos

Wear a range polo for continued comfort when the action heats up.

- Polyester-elastane fabric blend
- Moisture wicking
- Fade, shrink and wrinkle resistant
- 30+ UPF protection against harmful rays
- Easily fits over your concealed vest with four-way stretch fabrication

Sizes: Men's S-3X. Women's S-XL. See size charts M and N on p. 99

\$49.99
Men's 6R1-SW499
Women's 6R1-ST314

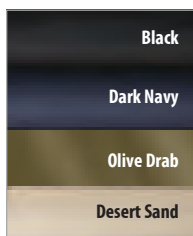

5.11®

5.11® Women's Trinity Polo

5.11 blends traditional design and modern function in the Trinity Polo just for women. This tactical-laden garment is constructed from durable polyester fiber for unbeatable resistance to abrasions, tears, soil and shrinkage.

- 5.31 oz, 100% polyester jersey knit
- Lightweight, breathable, moisture-wicking fabric
- Dual compartment pen pocket on left sleeve
- Standard mic pockets at chest seams
- Scope logo on back of neck, below the collar
- Drop tail for extra coverage

Sizes: Women's S-XL, see size chart I on p. 98

6R1-SR451 \$39.99



VISIT US ONLINE



Shop our full selection of polos at:
galls.com/polos

Almost 50 Years in Service

We are dedicated to serving our customers with quality products, customized services and quick deliveries. Call 800.477.7766 today to learn more.

Professional Polos



Black



Black



Navy

Silver Tan



UNDER ARMOUR®

Under Armour® WWP Performance Polo

The Wounded Warrior Project® Polo acknowledges and raises support for soldiers and their families who have sacrificed so much for our country. Wear this polo as a "thank you" to the bravest among us. Portion of proceeds benefit WWP.

- Polyester-elastane fabric
- Moisture Transport System wicks sweat
- ArmourBlock anti-odor technology
- Four-way stretch fabrication allows greater mobility in any direction

Colors: Men's Black, Storm. Women's Black/White, Harmony Red/White, Bold Aqua/White, Combat Green/Harmony Red. Sizes: S-3X. See size charts M and N on p. 99

\$49.99

Men's **6R1-ST311**
Women's **6R1-SG714**

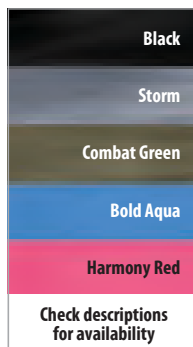

5.11

5.11® Odyssey Polo

5.11's Odyssey Polo is constructed of a polyester-spandex fabric to resist snags, rips and retain a wrinkle-free appearance. The fabric is moisture wicking, quick drying and anti-microbial to keep you feeling fresh all day. This polo also features a contemporary and precise fit.

- Polyester-spandex blend
- Moisture wicking
- Antimicrobial
- Snag and fade resistant
- Pen pocket on left sleeve; zippered chest pocket
- Gusseted construction
- Tonal 5.11 heat-sealed logo

Sizes: S-XL, see size chart A on p. 98

6R1-SG507 \$49.99+

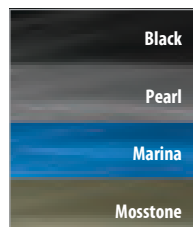

5.11

5.11® Helios Short Sleeve Polos

Built from lightweight, heat-resistant knit fabric, the Helios Polo will keep you looking sharp whether you're on duty or off duty.

- 4.5 oz, 100% polyester jersey knit
- Moisture-wicking technology
- Antimicrobial
- Snag resistant
- Pen pocket
- Mic clip pockets
- Underarm gussets
- Shoulder mic loops
- Sunglasses loop

Colors: Men' (all). Women's Black, Dark Navy, Charcoal, Silver Tan. Sizes: Men's S-3X, see size chart A on p. 98

\$49.99+

Men's **6R1-SM401**
Women's **6R1-SM402**

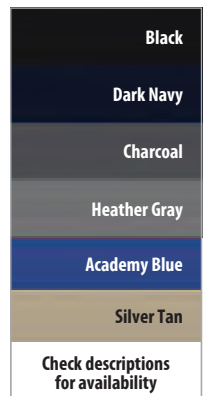

Sweat-Wicking and Odor-Fighting Polos

NEW

Jet Black



Long Sleeve

Short Sleeve



Oakley® Marksman Polo

Designed for duty wear, this performance polo from Oakley incorporates innovative fabric technologies. O Hydrolix™ actually carries perspiration away from the skin to the outer surface where it quickly evaporates. This moisture management system keeps you from overheating in hot temperatures and overcooling in chilly climates.

- 100% polyester
- Hydrolix™ moisture-wicking technology
- Antibacterial
- UPF 50+ protection

Sizes: S-2X, see size chart A on p. 98

6R1-SM502 \$55.00



Oakley® Transition Polo

Transition seamlessly from indoors to outdoors with the temperature regulation of O Hydrolix™ fabric. Plus, reversible design gives you double the styling options in one garment.

- 100% polyester
- Moisture-wicking action
- Antibacterial properties decrease odor-causing microbes
- UV protection shields you from harmful rays
- Chest pocket
- Engineered seams contour to your body for optimum mobility
- Regular fit

Sizes: S-2X, see size chart A on p. 98

6R1-SG802 \$70.00



Elbeco UFX™ Ultra-Light Hi Vis Polos

ANSI compliant polos keep you dry and comfortable with moisture-wicking performance.

- ANSI 2007-2010 Class II Level II
- 2" reflective striping around torso and sleeves
- 100% lightweight polyester
- Nano moisture wicking
- Antimicrobial
- UV 40+ protection
- Mic pocket; pen pocket on sleeve
- Rib knit collar with stays to prevent roll up
- Four-way stretch and flex mesh underarm vents
- Tagless label
- Utility loop at base of placket
- Extra-long body prevents ride up

Sizes: XS-4X, see size chart F on p. 98

Description	Item	Starting at
Short Sleeve	6R1-SG734	\$69.99
Long Sleeve	6R1-SG735	\$79.99

Your Solutions Provider

We have the resources and expertise to be your primary supplier for uniforms and equipment that you need to safely do your job.

As the industry leader for public safety uniforms and equipment, we offer what you would expect from almost 50 years experience.

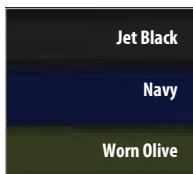

VISIT US ONLINE

Shop our full assortment of casual duty uniforms online at: galls.com/casual-duty-uniforms

Rugged and Ready to Work



Long Sleeve
Desert Sand



Long Sleeve
Khaki



Short Sleeve
Black



Short Sleeve
Black

Black
Dark Navy
Navy
Dark Brown
Charcoal
Hunter Green
Lincoln Green
Royal Blue
Red
Light Blue
Gulf Blue
Desert Sand
Khaki
Silver
White

Check descriptions for availability



Dickies® Work Shirts

Built tough, rugged and ready to work with a stain-release and moisture-wicking Visa® finish.

- Polyester-cotton twill fabric
- Generous fit across shoulder
- Doghouse sleeve plackets
- Extra-long tail

Colors: (ST286) all except Desert Sand. (ST285) Black, Dark Navy, Navy, Dark Brown, Lincoln Green, Gulf Blue, Desert Sand, Khaki, Silver. Sizes: (ST286) S-5X. (ST285) S-4X, see size chart A on p. 98.

Description	Item	Starting at
Short Sleeve	6R1-ST286	\$17.99+
Long Sleeve	6R1-ST285	\$19.99+



Wrangler™ Work Shirts

With innovative product features and a great fit, Wrangler Workwear delivers superior comfort and unlimited motion. Designed specifically for the needs of the active worker.

- Cotton-polyester canvas
- Soil release and color retention
- Wrinkle-resistant finish
- Banded collar with permanent stays
- 2 double-needle, button-thru, hex-style pockets with left pocket external pencil stall
- Double-needle stitching
- Full seamless underarm gussets
- Straight bottom hem with side vents

Colors: (ST099, SG119) all. (SG120) Navy, Charcoal, Light Blue, Khaki. Sizes: S-3X Reg, L-2X Lng. Women's S-3X

Description	Item	Starting at
Men's Short Sleeve	6R1-ST099	\$33.29+
Men's Long Sleeve	6R1-SG119	\$35.59+
Women's Long Sleeve	6R1-SG120	\$35.59

Black
Navy
Chocolate
Charcoal
Olive Drab
Light Blue
Khaki
Gray

Check descriptions for availability

[+](#) Visit us online for pricing on additional options.

Ordering online? Use your **PROMOTIONAL CODE** from the back cover

Hardworking Shirts Withstand Stains



NEW



Dickies® WorkTech Ventilated Performance Shirts

Dickies blends cool comfort with industrial strength for a work shirt that won't stop. Back and underarm mesh ventilation keeps air circulating through the garment, while moisture-wicking properties carry perspiration away from your skin. Flexible fabric allows for a free range of motion, a considerable benefit when work requires extended or repetitive movement. Treated to withstand stains and fading, even after several industrial washings, for stress-free care.

- 65% polyester, 35% cotton poplin; 100% polyester micro pique for polo
- 4.7 oz, 100% polyester AeroCool mesh
- Moisture wicking
- Stain release
- Color retention
- Two chest pockets; no pockets on polo
- Flex fabric; back and underarm mesh ventilation
- Self-collar, side vents and drop tail on polo

Colors: (SJ018, SJ017) Light Blue, Dark Navy, Black. (SM561) Dark Navy, Black, Charcoal, Red. Sizes: Men's S-4X Reg, M-3X Tall, see size chart A on p. 98

Description	Item	Price
Short Sleeve	6R1-SJ018	\$24.99+
Long Sleeve	6R1-SJ017	\$27.99+
Polo	6R1-SM561	\$21.99+

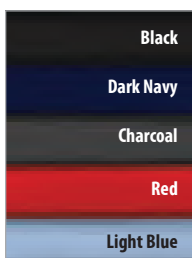

NEW



Galls® Work Shirts

Classic design and low-maintenance features unite in the Long Sleeve Shirts from Galls. Stain-release and wrinkle-resistant properties make for easy-care workwear that also withstands the rigors of industrial laundering. Fashioned from a combination of polyester and cotton poplin for a fabric fusion that will not disappoint, with polyester's built-in resistance to abrasions, tears and shrinkage, and cotton's innate breathability. Chest pockets provide a convenient spot to stow your identification.

- 4.5 oz, 65% polyester, 35% cotton poplin
- Stain release
- Wrinkle resistant
- Two front chest pockets
- RFID tag ready
- Industrial laundering
- Imported

Sizes: Men's S-7X, see size chart A on p. 98

starting at \$9.99+
Short Sleeve 6R1-SM622
Long Sleeve 6R1-SM621

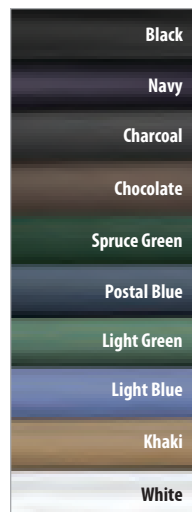

[+ Visit us online for pricing on additional options.](#)

Lightweight Shirts Keep You Comfortable



PROPPER™ Lightweight Tactical Ripstop Shirts

Comfortable and lightweight with a professional look.

- Polyester-cotton ripstop
- DuPont™ Teflon® treated to repel stains and liquids
- Fade and wrinkle resistant
- Hook-and-loop flap pockets with pen slots
- 2 zippered chest pockets
- Gusseted underarms
- Hidden zipper front with button front look

Sizes: (SR788) XS-4X. (SR882) S-3X Reg and Lng, see size chart A on p. 98

Description	Item	Price
Short Sleeve	6R1-SR788	\$34.99
Long Sleeve	6R1-SR822	\$39.99

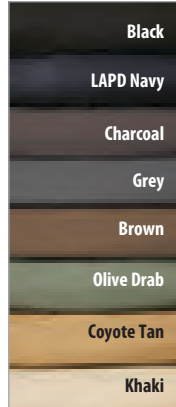

PROPPER™ Summerweight Tactical Shirts

These Class B shirts feature a large vented shoulder yoke for maximum airflow to cool you down in the hottest weather.

- Nylon and spandex ripstop
- Moisture wicking
- UV protection from harmful rays
- Chest pockets with fast-tab loops
- Pen pocket inside left chest pocket
- Side-access chest pocket with hook-and-loop closure
- Mesh-backed shoulder vent for breathability

Sizes: XS-4X, see size chart A on p. 98

Description	Item	Prices
Short Sleeve	6R1-SG705	\$44.99
Long Sleeve	6R1-SG704	\$49.99

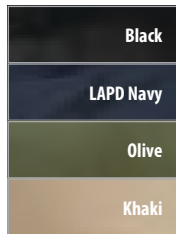

Vertx® Phantom LT Shirts

Repels liquids and absorbs perspiration.

- Polyester-cotton mini ripstop
- IntelliDry® fabric treatment for stain release
- Excellent color retention after washing
- Dual stall pen/pencil pockets
- 2 vertical map chest pockets with zipper closures
- Side stretch panels; interior back yoke mesh

Sizes: Men's S-XL Short, S-4X Reg and Lng, 2X-4X Extra-Lng, see size chart A on p. 98

Description	Item	Price
Short Sleeve	6R1-SR460	\$44.95+
Long Sleeve	6R1-SH723	\$49.95+

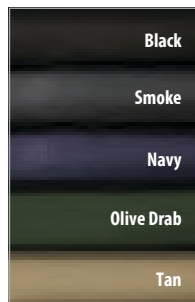

Tough Tactical Shirts for On or Off the Field



Uniform Shirt
Khaki



Field Shirt
Black



TRU-SPEC® 24-7 Tactical Lightweight Ripstop Uniform Shirt

Full-featured duty shirts are comfortable enough to wear on or off duty.

- Polyester-cotton ripstop fabric
- Bellowed front pockets and flaps with hook-and-loop closure; hidden document pockets
- Concealed zipper front closure with a smooth uniform appearance
- Two-button banded vent cuff with placket and Bryon collar
- Mic/sunglass holder and pen/pencil stall
- Slightly curved hem can be worn tucked or untucked

Men's Sizes: (SR869) S-4X Reg. (SR870) XS-4X Reg, S-3X Lng, see size chart A on p. 98

Description	Item	Starting at
Short Sleeve	6R1-SR869	\$42.95+
Long Sleeve	6R1-SR870	\$44.95+

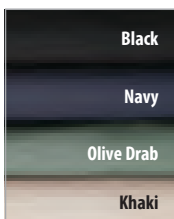

TRU-SPEC® 24-7 Tactical Lightweight Ripstop Field Shirt

Look great on or off duty with this comfortable field shirt. Plenty of pockets for all your gear, with underarm ventilation for breathability. Designed for a classic, professional fit.

- Polyester-cotton ripstop fabric
- Signature 24-7 Series bellowed front pockets and flaps with hook-and-loop closures and mesh inner pocket bags
- Pencil pockets between the front pockets and the placket
- Byron button down collar with hidden button
- Yoked back for better fit and professional look

Colors: Black, Navy, Olive Drab, Khaki. Men's Sizes: (SR841) S-4X Reg. (SR842) XS-4X Reg, S-3X Lng, see size chart A on p. 98

Description	Item	Starting at
Short Sleeve	6R1-SR841	\$42.95+
Long Sleeve	6R1-SR842	\$44.95+

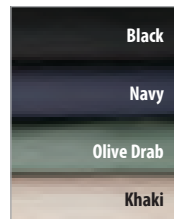

[+ Visit us online for pricing on additional options.](#)



Short Sleeve
Desert Sand

Long Sleeve
Desert Sand



TACTICAL Dickies® Ripstop Tactical Shirt

Dickies has loaded this Ripstop Tactical Shirt with plenty of hidden storage pockets, wrinkle resistance, moisture repellent and stain releasing technology. Lightweight flex fabric allows ease of movement in a relaxed fit.

- 4.75 oz, 85% cotton, 15% elasterell with sorona polyester
- Moisture wicking
- Wrinkle resistant; stain release
- Pencil sleeve pocket; chest storage pockets; hidden document pocket
- Hidden button-down collar
- Flex fabric for comfort and ease of movement
- Ventilated mesh panels
- Doghouse placket with adjustable cuff closure
- Sunglass loop
- Separate bag for epaulettes and badge holder

Sizes: (SG706) S-4X Reg. (SG709) S-4X Reg, M-3X Tall, see size chart A on p. 98

Description	Item	Price
Short Sleeve	6R1-SG706	\$38.99+
Long Sleeve	6R1-SG709	\$40.99+

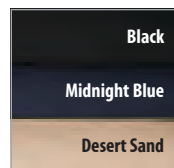

Cool Shirts for Covert Carry



White



TRU-SPEC® 24-7 Concealed-Carry Holster Shirt

Designed for concealed carry of handguns and will accommodate magazines, electronics and small equipment.

- Polyester-spandex fabric blend
- Flat lock construction
- Fitted

Sizes: S-3X, see size chart A on p. 98

6R1-UN142
starting at **\$49.95+**

Black
White



Crew Neck
White

Sleeveless
Black

V Neck
Black



5.11® Holster Shirts

Securely stows compact handguns and magazines, speed loaders or mp3 player.

- Polyester-spandex blend
- Inner foam layer for cushioning
- Mesh shoulder yoke to support extra weight
- Mesh outer layer to prevent printing

Colors: White, Black. Sizes: S-3X, see size chart A on p. 98

Starting at **\$69.99+**

Men's V-Neck	6R1-UA620
Men's Crew Neck	6R1-UA557
Men's Sleeveless	6R1-ST272
Women's Sleeveless	6R1-ST273



Sage



TRU-SPEC® 24-7 Cool Camp Shirt

Cooling properties combined with CW design make the 24-7 Cool Camp Shirt ideal for desert operations or outdoor excursions.

- Polyester/spandex blend
- Quick-dry and moisture-wicking properties keep you cool
- Wrinkle-resistant fabric with UV 50+ protection
- 2 chest pockets with flap closure
- Strategically located vents on underarm and shoulders
- Seamless shoulder construction offers additional comfort
- Button top placket allows speedy retrieval of sidearm

Sizes: S-4X, see size chart A on p. 98

6R1-SG791 **\$39.95+**

Black
Mountain Blue
Sage
Arctic Gray



Short Sleeve
Coyote



5.11® Cotton Canvas Shirts

Perfect everyday cotton canvas shirt works for almost any job.

- Moisture-wicking mesh venting on back to keep you cool
- Bellowed patch pockets, sleeve pencil pockets and 2 hidden secure chest pockets for documents or accessories
- Triple-needle stitched in high stress areas for durability
- Long sleeve has roll-up sleeve tabs

Sizes: S-3X Reg, S-5X Tall (Long Sleeve Tall sizes only available in Khaki), see size chart A on p. 98

Description	Item	Starting at
Short Sleeve	6R1-SH207	\$49.99+
Long Sleeve	6R1-SH209	\$54.99+

Black
Khaki
Sage
Fire Navy
Gray
OD Green
Coyote



Long Sleeve
Fire Navy

VISIT US ONLINE

Shop our full selection of concealed carry shirts at: galls.com/concealed-carry-shirts

+ Visit us online for pricing on additional options.

Lightweight Shorts for Cool Comfort



TRU-SPEC® 24-7 Simply Tactical Cargo Shorts

Available in big and tall sizes with a traditional cut.

- 6.5 oz, polyester-cotton ripstop
- 2 deep, reinforced, front-slashed pockets to hold tactical gear
- 2 cargo pockets with covered flap
- 2 cell/accessory phone pockets, sized to fit most smart phones
- Elastic waistband; gusseted crotch
- PRYM snap; YKK® zipper
- No VELCRO® brand closures
- Felled seams; 9" inseam

Colors: Black, Khaki, Navy. Sizes: Men's 28-60

6R1-TR740 \$22.95+



PROPPER™ BDU Shorts

BDU shorts provide functionality suited to warmer weather.

- Battle Rip® fabric
- Fade, shrink and wrinkle resistant
- Six-pocket design; fused pocket flaps
- Adjustable waist tab for secure fit
- 4 bartacks; zipper fly with button closure
- Felled inseam, outseam and seat seams
- 10" inseam

Sizes: Men's S-2X, see size chart A on p. 98

6R1-TR699 \$22.99



Khaki



Slider waistband for a comfortable fit

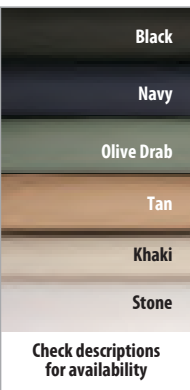

TRU-SPEC® 24-7 Ripstop Shorts

Polyester-cotton ripstop blend feels lighter than cotton.

- Polyester-cotton ripstop fabric
- Teflon® coating for stain resistance
- 14 pockets: 2 cargo pockets with 2 mag pockets in each; 2 external cell phone/mag pockets; 2 deep front slash pockets; 4 expandable rear pockets; 2 accessory/knife pockets
- Comfort-fit slider waistband
- Bartacked stress points for durability
- 9" inseam

Sizes: Men's 28-54

6R1-TR573 starting at \$34.95+



TRU-SPEC® 24-7 Eclipse Shorts

Designed with the same tactical features and spacious storage of the Eclipse Pants.

- 5.5 oz, 100% nylon
- Teflon® treated for moisture and stain resistance
- Front pockets with two interior utility pockets; large side pockets; concealed pocket behind button with hook-and-loop closure; pocket inside belt loop
- Cord channel in waist; gusseted crotch
- Prym® stud post button with rivets; YKK® zipper
- 9" inseam

Colors: Khaki, Black. Sizes: Men's 28-54

6R1-TT726 \$34.95+



No Hassle Guarantee

We will repair, replace or refund an order if you are not completely satisfied with a newly purchased item. Some restrictions apply.



Galls® EMS Shorts

Stain-resistant fabric keeps you looking professional throughout your shift. Extra room in the seat and the crotch, giving you the mobility you need in your demanding job.

- Polyester-cotton fabric
- Stain-resistant
- Accommodates up to 2 1/4" W belts
- YKK® zipper
- 10" inseam

Navy. Sizes: Men's 30-50

6R1-TR361 starting at \$36.79+



Slider waistband provides up to 3" of additional room



Galls® G-Force Tactical Shorts

Tactical shorts with plenty of storage.

- Polyester-cotton twill
- 2 back pockets with button tabs
- 2 cargo pockets with inner and outer compartments
- 2 SAP pockets
- Slider waistband for additional room
- Brass YKK® zipper with auto-lock
- 10" inseam

Sizes: Men's 28-54

6R1-TR365 starting at \$41.99+

Black

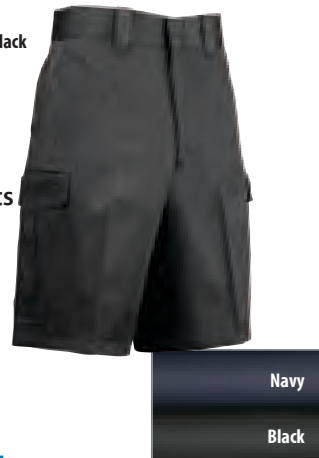

[+ Visit us online for pricing on additional options.](#)

★ PROPPER™

PROPPER™ Summer Weight Tactical Shorts

Stay cool in Class B shorts.

- 94% nylon, 6% spandex ripstop
- Moisture wicking
- Rapid-access cargo pockets; zip pockets; covert back pocket; hook-and-loop wallet pockets; mesh pocket bags
- Gusseted crotch, French fly
- 11" inseam

Sizes: Men's 28-52

6R1-TT592 \$39.99



Black

Black

LAPD Navy

Olive

Khaki



Ripstop

Canvas

Fabrics



Ripstop

TDU

Khaki

5.11

5.11® Shorts

Durable, comfortable and functional casual wear. Women's shorts are designed with a lower rise for a better fit.

- Pockets: extra-deep front pockets; rear strap and slash pockets; 3 thigh-mounted utility pockets; plus, convenient D-ring
- Double-thick seat
- Triple-stitch reinforcements; 48 individual bartacks
- Prym® snaps; locking flange YKK® zippers
- Inseams range from 9" to 11"; see below for details

Ripstop: Polyester-cotton ripstop fabric.

Colors: (TR886, TR626) all. (TR682) Black, Dark Navy, TDU Green, TDU Khaki. Sizes: (TR886) 28-44. (TR626) 28-54. (TR682) 2-20.

Starting at \$47.99+

Men's 11" **6R1-TR886**

Men's 9½" **6R1-TR626**

Women's 9" **6R1-TR682**

Canvas 9": Tough cotton canvas.

Colors: (TR190) all. (TR681) Khaki. Sizes: (TR190) 28-44. (TR681) 2-20.

Starting at \$47.99+

Men's **6R1-TR190**

Women's **6R1-TR681**

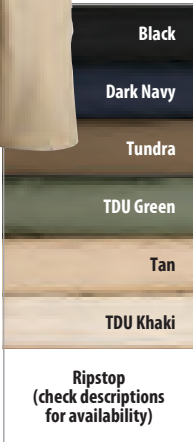

Black

Dark Navy

Tundra

TDU Green

Tan

TDU Khaki

Ripstop
(check descriptions
for availability)

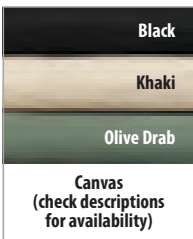

Black

Khaki

Olive Drab

Canvas
(check descriptions
for availability)



TDU Green

5.11

5.11® Stryke Shorts

5.11's popular Stryke pants are now available in 11" shorts. The Flex-Tac™ stretch fabric is treated with a Teflon® coating to repel stains and soils.

- Flex-Tac™ mechanical stretch fabric
- Teflon® finish
- Low-profile cargo pockets with internal magazine compartments
- Stretchable waistband; full running crotch gusset
- 11" inseam

Sizes: Men's 28, 30-36, 38-44 even

6R1-TT371 \$69.99

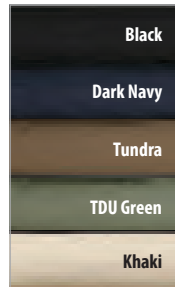

Black

Dark Navy

Tundra

TDU Green

Khaki

vertx

Vertx® Phantom LT Shorts

Lighter version of the Vertx cotton high speed pants. Mini-ripstop pattern weave is designed to effectively resist tears.

- 6.5 oz, 65% polyester, 35% cotton
- Mini-ripstop with IntelliDry fabric treatment
- Concealed zippered pocket on right size bearer; back pocket credential flap
- Multi-purpose inset cargo pockets with extra pocket inside
- 10" inseam

Colors: Khaki, Olive Drab, Tan. Sizes: Men's 28-44

6R1-TU229 \$48.95



Khaki

Olive Drab

Tan

Khaki

5.11

5.11® Vaporlite Shorts

Lightweight shorts are inspired by world-class three-gun shooters.

- 88% polyester, 12% spandex
- Lightweight, breathable, quick-drying, stretchable
- Eight pockets, including 5.11's AR-ready mag pockets
- Running gusset
- 11½" inseam

Sizes: Men's 28-44 even; 31, 33, 35 odd

6R1-TJ063 \$59.99



Black

Tundra

Storm

Stone

Khaki

Maximize Your Budget with Exclusive

NEW
WOMEN'S SIZES

Khaki

Khaki

\$22⁹⁹



Galls® Tac Force Tactical Pants

Our Tac Force Pants set the standard in affordable reliability and tactical function, making them a wardrobe mainstay for public safety professionals from every sector. Packed with pockets to keep essential gear handy and within reach. Automatically adjusting elastic waistband offers all-day comfort and mobility in dynamic environments.

- 6 oz, 65% polyester, 35% cotton ripstop fabric
- 2 side pockets; 2 back welt pockets
- 2 cargo pockets with VELCRO® closure; magazine holders inside of cargo pockets
- Utility pocket
- Elastic waistband with D-ring on each side of waist; mag elastic in waistband
- Reinforced knee
- Gusseted crotch
- Prym® snaps; YKK® zipper
- Feminine fit for women

Sizes: Men's 28-44, with even inseams 30"-34".
Women's 2-24. **FREE** hemming available, see p. 100

\$22.99

Men's **6R1-TT784**
Women's **6R1-TT846**

Black

Navy

Khaki

Tactical Trousers from Galls®

Starting at
\$29⁹⁹

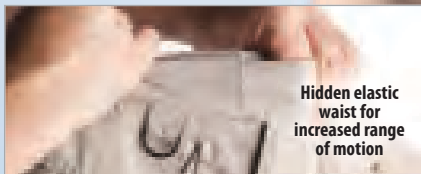

Hidden elastic waist for increased range of motion



Designed for a better fit



Features include hidden zipper pocket, utility pocket & D ring



Bellows pockets have three internal compartments

Khaki



Galls® G-TAC Tactical Pants

The lightest weight and most affordable tactical pants available. Loaded with features that make them your perfect tactical pant choice.

- 5.6 oz, 65% polyester, 35% cotton ripstop
- Treated for soil and stain resistance
- 10 pockets for maximum storage
- Drop-yoke, low-profile design aligned with two back pockets for clean seaming
- Hidden elastic waist includes a hidden coin/key pocket on inner waist with hook/loop closure
- Bartacking on belt loops for rigger belt or duty belt
- D ring on each side of waist
- Reinforced knee with opening for kneepads (not included)
- Prym® snaps; YKK® zipper

Sizes: Men's 28-58, with even inseams 30"-34" and unhemmed. **FREE** hemming available, see p. 100. View this product's video @ galls.com

6R1-TR940 \$29.99

Alta Shockguard Kneepad Insert
6R1-TP315 \$29.39

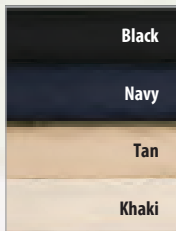

Black

Navy

Tan

Khaki

Built for Durability



\$39.99

Khaki

- Black
 - Charcoal Gray
 - LAPD Navy
 - Sheriff's Brown
 - Coyote
 - Khaki
 - Olive
 - Light Gray
- See website for additional colors

★ PROPPER™ PROPPER™ Lightweight Tactical Trousers

Action stretch waistband provides comfort and mobility.

- 6.5 oz, 65% polyester, 35% cotton
- DuPont™ Teflon® treatment to repel stains and liquids; fade and wrinkle resistant
- 9-pocket design with internal kneepad openings
- Reinforced front pocket opening prevents ripping and fraying
- D-ring for key or tools
- Heavy-duty double seat and knee
- Sturdy snap closure with French fly

Sizes: Men's 30-44, available hemmed 30-36 even, 28, 46-56 unhemmed.
Women's 2-24 even and unhemmed

\$39.99

Men's **6R1-TU019**
Women's **6R1-TU076**

FREE Hemming
p. 100



Midnight Blue



TACTICAL Dickies® Ripstop Stretch Tactical Pants

These pants have you covered whether you're working in public safety or construction.

- 6.5 oz, 43% elasterell with sorona, 34% cotton, 23% polyester
- Premium construction
- DuPont™ Teflon® to repel water and stains
- Multi-pocket storage; inset back pockets
- Triple-gripper waistband for comfort
- Low-profile look
- Metal tack buttons; relaxed fit
- Women's pants designed for women for a more precise fit

Men's Sizes: 30-48. Women's Sizes: 4-24W.

FREE hemming available, see p. 100

\$44.99

Men's **6R1-TT680**
Women's **6R1-TT613**

- Black
 - Midnight Blue
 - Tactical Green
 - Desert Sand
- Pant Colors

with Multiple Pockets for Storage



Fabric Choices

Canvas

Ripstop

Black

Navy

Charcoal

Olive Drab

Brown

Coyote

Khaki

Stone

Check descriptions for availability



TRU-SPEC® 24-7 Tactical Pants

These tactical pants are built for durability, versatility and offer a terrific fit. Features a great contemporary style that will fit in almost anywhere, on or off duty.

- 14 pockets including 2 cargo pockets with 2 mag pockets in each, external cell phone/mag pockets on both legs, 2 extra deep front slash pockets, 4 expandable rear pockets and a knife/accessory pocket on each side
- Comfort-fit slider waistband; reinforced knee with kneepad pockets
- Bartacked stress points for durability

Sizes: Men's 28-54 even, up to size 44 come hemmed in inseams 30-36". Women's 2-24.

FREE hemming up to 34" inseam for men's sizes 46-54 and 33" for women's pants, see p. 100

Ripstop Pants: Offer all-season comfort, durability and functionality. They are perfect for warm climates and year-round wear. Made of a 6.5 oz, 65% polyester, 35% cotton with stain-resistant Teflon® coating.

Colors: (TR549) Black, Navy, Charcoal, Olive Drab, Brown, Coyote, Khaki, Stone. (TR625) Black, Navy, Olive Drab, Khaki

Starting at \$44.95+

Men's **6R1-TR549**

Women's **6R1-TR625**

Men's Canvas Pants: 8.5 oz, pre-shrunk cotton canvas fabric.

Colors: (TR504) Black, Navy, Olive Drab, Coyote and Khaki

6R1-TR504 starting at \$44.95+



Slider waistband for a comfortable fit



TRU-SPEC® 24-7 Eclipse Pants

Supreme storage and functionality when you need it most.

- Choose Quick-Dri durable nylon or polyester-cotton ripstop fabric
- Breathable and moisture-wicking
- 8 pockets to carry all your gear, including utility and mag pockets
- Button holes in waistband and bottom hem to add optional drawstrings
- Articulated knees and gusseted crotch for increased mobility
- Brass Prym® stud posts on hip pockets
- YKK® brass zipper

Sizes: Men's 28-44, inseam 30-34". Colors (TR745) Khaki, Black. (TU601) Khaki, Black, Coyote

\$44.95

Nylon **6R1-TR745**

Ripstop **6R1-TU601**

Black

Coyote

Khaki

Check descriptions for availability



Visit us online for pricing on additional options.

Ordering online? Use your **PROMOTIONAL CODE** from the back cover

800.477.7766 • galls.com

31

Tackle High-Stress Situations



★ PROPPER™

PROPPER™ Tactical Pants with Stretch

Tackle high-stress situations in PROPPER's best-selling tactical pants, now in stretch fabric for maximum mobility and enhanced comfort.

- 96% nylon, 4% spandex
- DWR (Durable Water Resistant) finish resists liquids and stains
- 2 hook-and-loop back pockets with wallet "pocket in a pocket"
- 2 front slash pockets with reinforced opening supply a secure storage location for knives or other sharp gear
- 2 concealed pockets are ideal for badge or currency
- D-ring allows instant access to keys
- Action-stretch waistband delivers additional comfort
- Heavy-duty construction of seat and knees offers maximum durability, with option of adding kneepads (sold separately)
- Zipper fly with snap closure

Sizes: Men's 28, inseam 30"-44" even and unhemmed; 32, 34, 36, 46-56 unhemmed.

FREE hemming available, see p. 100

6R1-TT709 \$49.99

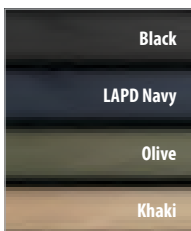

★ PROPPER™

PROPPER™ Summerweight Tactical Pants

Beat the heat in summerweight attire.

- Nylon and spandex ripstop
- Moisture wicking
- Rapid-access lay-flat cargo pockets on upper thighs
- Zip pockets on upper thighs for secure storage
- Covert back pocket for keycard or handcuff key
- Mesh pocket bags for increased breathability
- Nylon pocket reinforcements
- Shorts feature hook-and-loop rear wallet pockets
- Pants feature zippered rear wallet pockets
- Gusseted crotch allows greater range of motion
- French fly with zippered closure

Sizes: 30-44 even, inseams 30"-36"; 28, 46-56 even, unhemmed. **FREE** hemming available, see p. 100

6R1-TT554 \$49.99

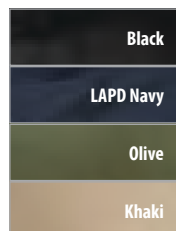

★ PROPPER™

PROPPER™ STL III Pants

A clean look and streamlined functionality in a professional four-pocket design. An improved stretch material and gusseted crotch provides the added mobility you need for dynamic movements and situations.

- Nylon and spandex fabric
- DWR (Durable Water Resistant) finish
- Signature-concealed pocket at the center back
- Slim zippered thigh pocket for secure storage
- Streamlined fit with low-profile ergonomic thigh pockets

Sizes: 30-44 even, inseams 30"-36"

6R1-TU597 \$49.99

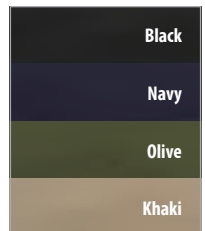

in Versatile Tactical Pants

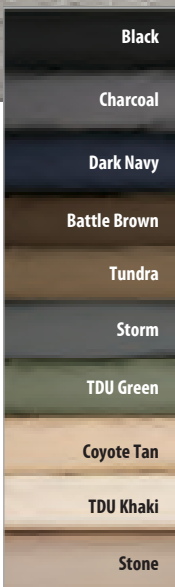
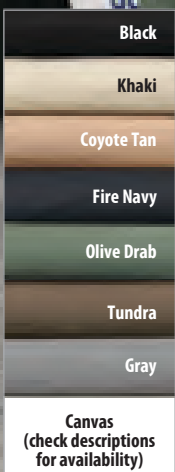

Khaki



5.11

5.11® Tactical Pants

Available for both men and women. Women's pants feature a lower rise for a better fit.

- Trademark slash pockets and patented straps
- Double reinforced seat, knees and hidden kneepad pockets (kneepads sold separately)

Sizes: Men's 28-54 hemmed, inseams 30"-36" even. **FREE** hemming available up to 34" for sizes 46-54, see p. 100. Women's (waist/inseam) 2- 30¼", 4-30½", 6-30¾", 8-31", 10-31¼", 12-31½", 14- 31¾", 16-32", 18-33¼", 20-32½"

Ripstop Taclite®: Extremely lightweight yet durable polyester-cotton ripstop fabric.

- Teflon® finish for stain, liquid and soil resistance
- Abrasion, fade and wrinkle resistant
- Welded pocket added to right side, parallel to magazine pocket
- Diamond gusset crotch for outstanding durability and flexibility

Colors: Men's sizes 28-44 available in all colors; 46-54 available in Black, Charcoal, Dark Navy, TDU Green, Coyote Tan, TDU Khaki (sizes 46-50 not available in Stone). Women's Black, Charcoal, Dark Navy, TDU Green, TDU Khaki

Starting at \$49.99+

Men's **6R1-TR506**
Women's **6R1-TR642**

Canvas: Exceptional performance, comfort and durability of cotton canvas.

- 7 pockets, D-ring and tool strap
- Elastic waist for mobility

Colors: Men's sizes 28-44 available in all colors; 46-54 available in Black, Khaki. Women's Black, Khaki, Fire Navy

Starting at \$49.99+

Men's **6R1-TR135**
Women's **6R1-TR641**

[+](#) Visit us online for pricing on additional options.



Vertex® Phantom LT Pants

All Phantom LTs repel liquids and absorb perspiration.

- 6.5 oz, polyester-cotton mini ripstop
- IntelliDry® fabric treatment for stain release
- Excellent color retention after washing
- Back pocket credential flap and multi-purpose cargo pockets for duty gear
- Articulated waistband, crotch, knee and rise for superior mobility and comfort

Colors: all. Sizes: Men's 28-31 all, 32-44 even (inseams 30-36"), 46-54 (up to 34" inseam). Women's 6-18, inseam 34". **FREE** hemming to 35", see p. 100

Starting at \$50.95+

Men's **6R1-TR937**
Women's **6R1-TR938**

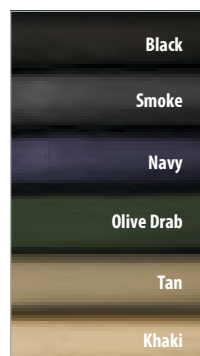

Ordering online? Use your **PROMOTIONAL CODE** from the back cover

800.477.7766 • galls.com

Durable, Comfortable and Functional



Khaki



Articulated knee enhances mobility without pulling



Vertx® High Speed Pants

Inset cargo pockets provide needed storage without giving a tactical appearance. Absence of snaps or VELCRO® brand provides instant access to stored items.

- Cotton-spandex blend with permanent stretch and recovery
- Utility notch pocket with concealed zippered security pocket
- Hidden cell phone or spare mag pocket
- Tunnel elastic waistband for increased comfort
- Articulated knee enhances mobility when bending, kneeling or climbing

Colors: Men's all. Women's all except Smoke. Sizes: Men's 32-44 come in hemmed sizes 30, 32 or 34; 28-31 available in 30 or 32 inseams; 46-54 can be hemmed up to 34; order unhemmed for 36 inseam. Women's 6-18

Starting at \$50.95+

Men's 6R1-TR639

Women's 6R1-TR662

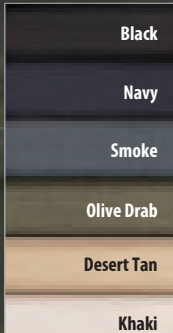

Check descriptions for availability



Khaki

5.11

5.11® Covert Cargo Pants

Durable, comfortable and functional Covert Pants stand up to the rigors of daily work, play and travel.

- 8.5 oz, peached cotton canvas
- Cordura nylon lining in select zones
- Large covert cargo pockets on both legs; each capable of carrying two 30-rd AR15/M4 mags
- Deep rear pockets; dual front deep pockets
- 1 traditional and a second zippered pocket; capable of carrying two pistol mags per pocket
- Self-adjusting comfort waistband
- Double- and triple-stitch construction
- Bartacks in stress areas
- Prym® snaps
- YKK® zippers
- Superior fit

Sizes: Men's 28-44, inseam 30-34"

6R1-TR653 \$54.99



Hidden side seam cargo pockets sized for AR magazines

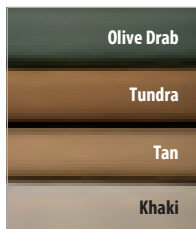

Pants for the Station, Range or Patrol

Black



TRU-SPEC® 24-7 Ascent Pants

Tactical functionality and mobility paired with advanced fabric solutions make Ascent Pants the strategic and low-maintenance choice.

- 6.5 oz, 65%, 35% polyester-cotton micro ripstop mechanical stretch fabric
- Teflon® finish for stain and soil resistance
- 2½" wide front utility pocket is reinforced to carry duty gear
- Badge holder on front loop doubles in use as a hidden compact pocket
- Inset cargo pockets and discrete reinforced knees create a streamline silhouette
- Convenient pocket located behind each cargo pocket for keys or cell phone
- Kneepad additions are possible with interior knee pockets (sold separately)
- Fitted waist
- Gusseted crotch, with bartacks at stress areas
- Prym® snap closure with YKK® brass zipper

Colors (TU642) Khaki, Black, Coyote, Navy. (TT724) Khaki, Black. Sizes: Men's 28-44, inseam 30-34". Women's 0-24

\$59.95

Men's **6R1-TU642**
Women's **6R1-TT724**

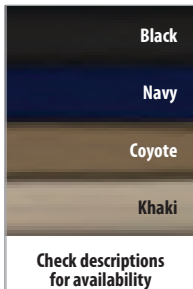

Khaki

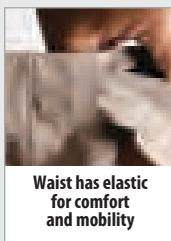
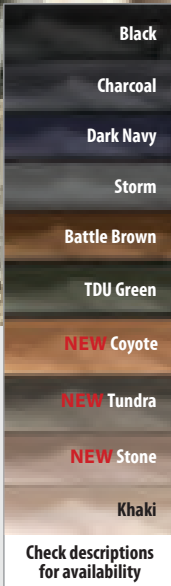

**NEW
COLORS**

5.11

5.11® Stryke Pants with Flex-Tac®

Flex-Tac® mechanical stretch ripstop fabric enhances fit and comfort. Men's are now available in Coyote and Stone; Women's in Tundra.

- Flex-Tac® stretch fabric
- Teflon® coating for stain and soil resistance
- Patented multi-use cargo pockets
- Low-profile cargo pockets, ergonomic design
- Double knee with kneepad access inside
- Badge holders on front belt loops
- Locking slider zipper
- Prym® snaps

Sizes: Men's 28-44, inseam 30-36" even. Women's 2-20, Reg/Lng. Colors: (TR909) all. (TR980) Black, Dark Navy, Storm, TDU Green, Tundra, Khaki

Starting at \$69.99+

Men's **6R1-TR909**
Women's **6R1-TR980**

+ Visit us online for pricing on additional options.

Strong Enough for any Challenge



5.11

5.11® Women's Cirrus Pants

Featuring a modern women's fit in the Flex-Tac stretch fabric with dual mag pockets for a casual look on or off duty.

- 6.76 oz, 65% polyester, 35% cotton ripstop
- Flex-Tac mechanical stretch
- Teflon® treated for moisture, stain and soil resistance
- Reinforced cargo pockets for storage
- Front knife and cell phone pockets are reinforced for durability
- Back pocket openings are double stitched for heavy-duty use
- Dual magazine pockets at seat seam
- Stretch, fitted waistband with 7 belt loops
- Articulated knees with kneepad pockets
- Gusseted crotch; bartacked at stress points
- Prym® snaps; YKK® zipper

Sizes: Men's 28-44 even, inseams 30-34"

6R1-TR756 \$69.99

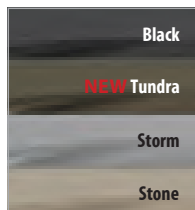

5.11

5.11® Ridgeline Pants

These casual pants provide a comfort waist, mag pockets and more for on or off-duty.

- Polyester-cotton, Flex-Tac ripstop
- Teflon® treated finish for spill and stain resistance
- Front hand pocket openings with self-fabric facings and reinforced with Cordura®
- Back welt pockets hold 2 pistol mags
- Comfortable fixed waist
- Reinforced double knees with kneepad access
- Full inseam gusseted crotch

Sizes: Men's 28-44 even, 31-35 odd, inseams 30-36"

6R1-TR748 \$69.99

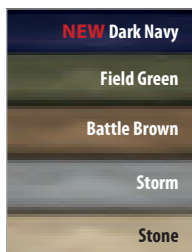

5.11

5.11® Apex Pants

Apex Pants are the epitome of functionality and durability. Pockets are sized for flex cuffs, handcuff keys and AR mags. Trousers are also treated with Teflon® to keep you looking sharp and professional throughout your shift.

- Polyester-cotton blend
- 6.4 oz, Flex-Tac mechanical stretch canvas
- Teflon® treated to repel stains, soil and moisture
- Internal cargo pouch and twin back yoke mag pockets
- Flex cuff pocket inside front waist; handcuff key pocket inside rear waist
- Comfort waistband; adjustable waist tabs
- Hidden buttons
- 1-3/4" wide belt loops; 7 reinforced belt loops
- Gusseted crotch, articulated knees and roomy thighs
- Bartacking at key stress locations
- Reinforced knife clip area
- Button fly; YKK® zipper
- 10" inseam

Sizes: Men's 28-44 even, inseams 30-36"

6R1-TT824 \$79.99

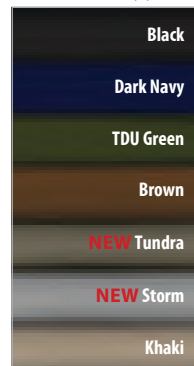

You Face On or Off the Field

Tan



Coyote Brown



Tundra



NEW



Under Armour® Storm Covert Pants

Built to face any challenge you face on the field, these pants are treated with a DWR (Durable Water Repellent) treatment so water beads up and rolls off. What's more, the DWR finish repels water without sacrificing breathability. You will also enjoy the full range of motion that the mechanical stretch fabric affords. Field-friendly features include a CCW-compatible waistband and secure cargo storage.

- 100% polyester with mechanical stretch
- UA Storm gear uses a DWR finish
- 2 secure cargo pockets; 2 back pockets; 2 front slash pockets
- Elastic waistband; reinforced knees and crotch

Sizes: Men's 30-42/30, 30-44/32, 32-44/34

6R1-TT596 \$79.99

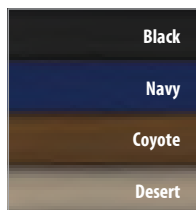

Under Armour® Tac Patrol Pants

Made for our men and women who serve and protect. Ripstop fabric stands up to tough treatment for the maximum in durability.

- 100% polyester
- Durable ripstop fabric
- Signature Moisture Transport System
- Anti-odor technology

Colors: (TT600) Black, Coyote Brown, Desert Sand, Dark Navy. (TT607) Black, Coyote Brown, Desert Sand, Dark Navy, Marine Olive Drab. Sizes: Men's 30-44 even, 30-34" inseams; Women's 0-12 even

\$79.99

Men's **6R1-TT600**
Women's **6R1-TT607**

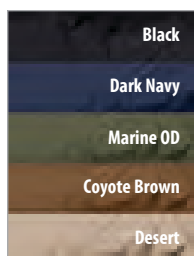

5.11

5.11® Traverse 2.0 Pants

The ever-popular Traverse Pants are now available in a lighter fabric. 5.11 replaced a double-weave fabric with a cooler single-weave that resists abrasion and pilling; and replaced the elastic with mag pockets.

- 87% polyester, 13% spandex; single-weave fabric
- Pilling and abrasion resistant
- DWR finish to repel light rain
- 10 pockets, including 5.11's AR-ready pockets
- Gusseting for incredible range of motion and comfort
- Double-reinforced, articulated knees
- Full-inseam running; kick plate on back hem

Sizes: Men's 28-44 even, inseams 30-36"

6R1-TJ064 \$89.99

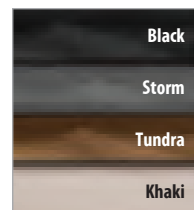

Built for Long-Lasting Wear

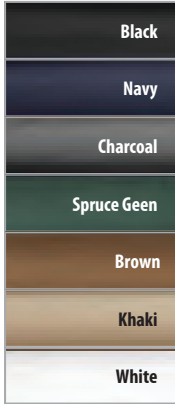

Khaki



Red Kap® Polyester-Cotton Plain Front Trousers

Double stitched for durability and lasting professional look.

- Dacron polyester and combed cotton twill blend
- Permanent-press finish; wrinkle resistance
- Front pockets and hip pockets
- Security button closure at waist

Sizes: 28-58 unhemmed

6R1-TR187 \$19.99+

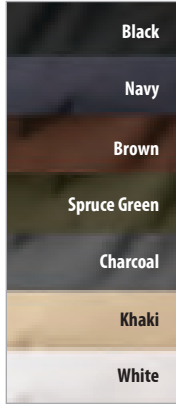

Khaki



Galls® Polyester-Cotton Twill Work Pants

Traditional work pants at a price you'll love. There's plenty of pockets for your tools, accessories or gear.

- Polyester-cotton twill blend
- 2 front slash pockets
- 2 back welt pockets
- Button closure on left pocket
- Zipper and button closure

Sizes: 28-60 unhemmed

6R1-TR972 starting at \$21.39+



Red Kap® Men's Prewashed Indigo Denim Jeans

A classic fit with a traditional rise that sits at the natural waist. Slimmer leg opening to fit over boots.

- Cotton denim
- Traditional five pocket styling
- Metal button at waist, ratcheting zipper
- Felled outseam, seatseam and riser seam

Sizes: 28-54 even, 30-36" and unhemmed inseams

6R1-TT127 starting at \$24.39+



Dark Navy



Dickies® Premium Industrial Pants

Dickies is hard to beat when it comes to durability.

- Permanent-press postcured finish
- StayDark® technology to reduce fading
- Extra pocket on outside left cargo and inside right cargo pocket
- Both styles have reinforced front pockets
- Metal tack button waist closure
- Relaxed fit

Sizes: (TR898, TR897) 28-60 even. (TU162) 30-60 even

Polyester/Cotton: Polyester-cotton vat-dyed twill.

Description	Item	Starting at
Flat Front	6R1-TR898	\$21.99+
Cargo	6R1-TR897	\$24.99+

Cotton Cargo: Cotton vat-dyed twill.

6R1-TU162 starting at \$27.99+

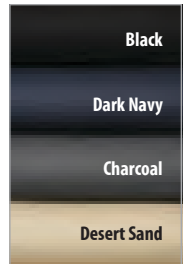

+ Visit us online for pricing on additional options.

and Harsh Environments



Wrangler
WORKWEAR

Wrangler™ Hero Five Star Relaxed Fit Jeans

The relaxed fit sits at the natural waist with a relaxed seat and thighs for comfortable movement.

- Heavyweight cotton
- Prewashed denim fabric
- Traditional five pocket design
- Heavy-duty brass zipper and button closure

Sizes: 32-38 even, 30-34" inseams; 30-32 even, 40-46" inseams

6R1-TT133 starting at \$35.59



LOWER PRICES

EXCLUSIVE ITEMS

tested to work

Mascot® Pants

Mascot's polyester-cotton pants are tested in accordance with *EN ISO 15797* for industrial washing.

- Polyester-cotton blend
- Reflectors
- Low waist and form-cut waistband
- Triple-stitched seams at leg and crotch

Sizes: 32½" - 40½" even, 32", 35" inseams

New Haven Service: Reinforced Service Pants for all the tough demands at work or off duty. Triple stitched in the legs and crotch to withstand plenty of abuse.

Colors: Black, Dark Navy, Dark Anthracite

6R1-TT148 WAS \$80.00
NOW \$55.99

Houston Kneepad: Kneepad pockets sit perfectly every time you kneel. These pants are triple stitched for long-lasting wear in tough conditions. They're not only durable but also very comfortable.

Dark Anthracite

6R1-TT147
WAS \$95.00
NOW \$57.99

New Haven Service
Black

Houston Kneepad
Dark Anthracite

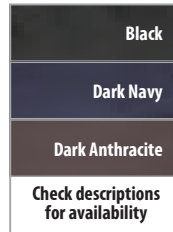

Brown



Carhartt

Carhartt Flannel Lined Washed Duck Dungarees

Designed for those tough jobs in the middle of winter.

- Ringspun cotton duck with cotton flannel lining
- Multiple tool and utility pockets
- Left leg hammer loop
- Full seat and thigh

Sizes: 30-34 even, 30-36" inseams; 36-40 even, 30-36" inseams

6R1-TU735
\$49.99

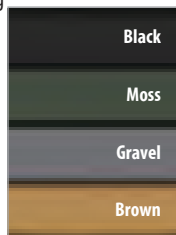

Men's
Black

Women's
Khaki



Wrangler
WORKWEAR

Wrangler™ Canvas Functional Pants

Built for incredible strength, yet stylish enough for a professional work environment.

- Cotton-polyester canvas
- Color retention, soil release and wrinkle resistance
- Front pockets have 13" reinforced pocket bag
- 2 slack-style front, 2 set-in hip and 2 patch leg pockets with exterior utility pocket
- Lower rise than traditional work pants

Colors: (TT135) Black, Charcoal, Navy, Khaki. (TE136) Navy, Khaki. Sizes: Men's 30-50. Women's 4-22 even, 34" inseam

Starting at \$41.69+
Men's **6R1-TT135**
Women's **6R1-TE136**

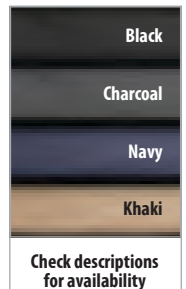

Natural Stretch and Comfort with Kühl®



Kühl® Revolvr Pants

Patina dye and river wash lend a vintage look to these signature pants from Kühl.

- Uberkuhl™ fabric: 74% combed cotton canvas, 26% nylon
- Shrink resistant
- Traditional five-pocket pant design with additional cell phone pocket
- Double-layer scuff-guard at cuffs and pockets; Born Free™ gusseted crotch
- Exclusive free ride waist; full cut

Sizes: Men's 28-42E, 31, 33, 35; 30" and 32" inseam in all 34" in waist 30 and up

6R1-TJ001 \$75.00

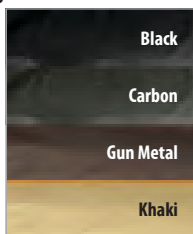

Kühl® Liberator Convertible Pants

Kühl integrates Rhino Technology, placing rugged non-stretch fabrics on top of soft, stretchy fabric. The result is a next-to-skin flexibility.

- 77% nylon, 23% cotton
- DWR (Durable Water Repellent) finish
- Rhino Technology in high-mobility areas
- 9 pockets
- Pants convert to shorts with snag-free zippers
- Inseam on shorts: 10½"

Sizes: Men's 30-42

6R1-TU669 \$95.00

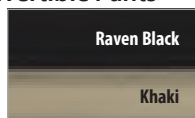

Kühl® Women's Anika Convertible Pants

Experience the liberating design as you trek the most challenging terrain, with relaxed leg tailoring for ease of movement.

- 88% nylon, 12% spandex
- DWR (Durable Water Repellent) finish
- 6 pockets
- Pants convert to shorts
- Inseam on shorts: 10"

Sizes: Women's 2-16

6R1-TU576 \$89.00

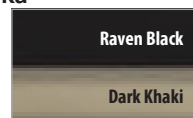

**Almost 50 Years
in Service**

We are dedicated to serving our customers with quality products, customized services and quick deliveries. Call 800.477.7766 today to learn more.

Kühl® Raid Belt

Fully functional belt features pre-curved webbing for a 3-D anatomical fit. Your hips naturally rise in the back, and the Raid Belt follows this natural curve for an organic fit. Designed to work with all Kühl branded pants.

- Polyester woven webbing with double-side color
- Nickel quick-release buckle
- Pre-curved anatomical fit

Black. Sizes: S 30-32, M 34-36, L 38-42

6R1-NY565 \$39.00



Add the Finishing Touch



Galls® Traditional Style Trouser Belt

Affordable, but as durable as more expensive belts. Water resistant. 1¾"W. Nickel hardware.

Sizes: Men's 28-60. Order one size larger than normal to ensure proper fit

6R1-LP157 starting at \$22.99+



Gould & Goodrich™ Leather Trouser Belt

Your choice of removable buckle. 1¾"W of hand-creased black leather with rubbed edges.

Sizes: Men's 28-62

6R1-LP072 \$40.59



+ Visit us online for pricing on additional options.

NEW

★ PROPPER™

PROPPER™ Tactical Nylon Belt

Security checkpoint friendly with plastic buckle. Provides utility in any setting. Nylon fabric for lightweight wear.

Sizes: Men's 30-58, see size chart G on p. 98

6R1-NY037 \$7.99



★ PROPPER™

PROPPER™ 360 Belt

Wear this functional duty belt with casual apparel and hiking gear. Inspired by land and airborne firefighter belts. Strong webbing to support a full range of accessories and tools. 1½"W.

Made in the USA. Finishes: Gunmetal, Black Oxide

6R1-NP659 \$19.99

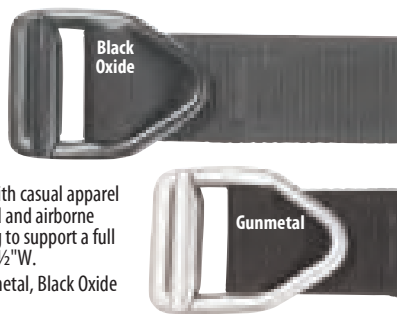

TRU-SPEC® Belt

Security-friendly, non-metallic buckle for easy, quick clearance at security checkpoints. Includes a hidden pocket. 1¾"W

Sizes: Men's S-3X, see size chart G on p. 98

6R1-NP989 \$8.95



TRU-SPEC® Range Belt

Nylon webbing is 1¾"W. Non-corrosive metal buckle with matte finish.

Sizes: Men's S-3X, see size chart G on p. 98

6R1-TE898 starting at \$14.95+

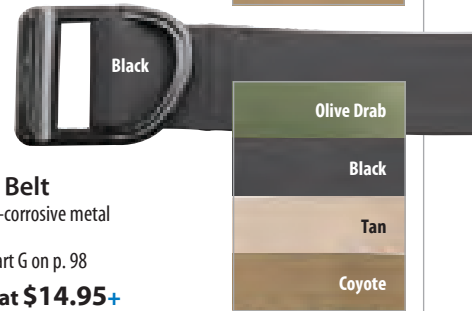

5.11

5.11 Tactical® Series TDU Belt

Security-friendly web belt with non-metallic buckle.

Sizes: Men's S-4X, see size chart A on p. 98

Starting at \$17.99+

1¾"W **6R1-NP571**

1½"W **6R1-NP569**



5.11

5.11 Tactical® Series Operator Belt

Double-thick 1¾"W webbing with Permastiff™ nylon insert to support holster wear. Black stainless steel buckle. 6000-lb rating.

Sizes: Men's S-4X, see size chart A on p. 98

6R1-NP516 \$39.99+



5.11

5.11 Tactical® Trainer Belt

Double thick 1½"W five row stitched webbing. Black stainless steel buckle. 6000 lb rating.

Sizes: Men's S-4X, see size chart A on p. 98

6R1-NP517 starting at \$39.99+

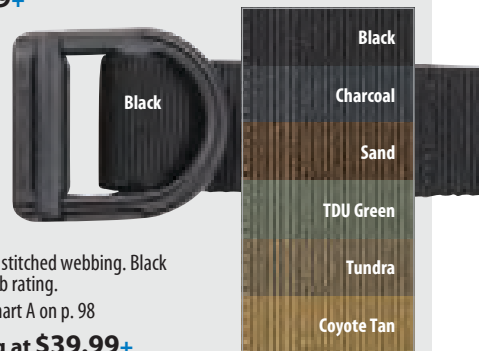

All 5.11® Belts convert to tie down, carry strap or emergency harness.

VISIT US ONLINE

Shop our extensive line of trouser and tactical belts at: galls.com/duty-belts

Ordering online? Use your **PROMOTIONAL CODE** from the back cover

800.477.7766 • galls.com

41

Zippered Pullovers and Sweaters



Hoodie
Charcoal

Quarter Zip
Black



TRU-SPEC® 24-7 Grid Fleece

Breathable, grid fleece lining wicks away moisture to keep you dry during high-intensity training.

- Polyester-spandex fabric blend
- Grid fleece provides moisture-wicking performance and increased breathability
- Thumb holes on both sleeves

Sizes: Men's S-4X, see size chart A on p. 98

Hoodie

- Center front zipper with semi-auto lock slider
- Kangaroo pocket with inside zippered patch pocket

6R1-ST644 starting at \$49.95+

Quarter Zip

- Concealed side pockets
- Front and back sleeve seams curved to improve articulation
- Mic loop at bottom of zipper

6R1-ST643 starting at \$49.95+

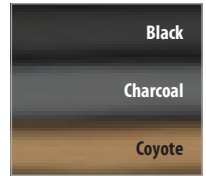

[+ Visit us online for pricing on additional options.](#)



Atlantis

Nautical

5.11

5.11 Tactical® Recon Half-Zip Fleeces

Warmth without the weight: Lightweight fleece-knit keeps you comfortable without the bulk.

- Polyester-spandex fleece knit
- Textured inner face of fabric helps retain body heat
- YKK® lock-down zippered chest pocket offers within-reach storage when worn as a base or middle layer
- Full underarm gussets
- Flat-lock stitching

Colors: Men's Black, Sage Green, Nautical, Women's Black, Atlantis, Jade. Sizes: Men's S-2X. Women's S-XL. See size charts A and I on p. 98

\$74.99

Men's Recon
Women's Glacier

6R1-ST651

6R1-ST652

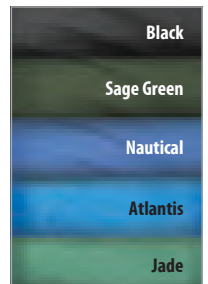

[Check descriptions for availability](#)

for Adaptable Warmth

5.11

5.11 Tactical® ¼ Zip Sweater

5.11 Tactical Quarter-Zip Sweater incorporates polyester fleece construction for 21st century performance. Zip secured chest pockets and a lumbar pocket provide easy access to essentials.

- Polyester sweater fleece
- Abrasion-resistant shoulder and elbow patches
- Zip secured back lumbar pocket
- Zip secured chest pockets

Sizes: Men's S-2X, see size chart A on p. 98

6R1-ST653 \$89.99

5.11 Tactical® Full-Zip Sweater

Perfectly suited for covert, field duty or off duty wear. Combines the functionality of a TDU jacket with a stylish sweater.

- Polyester body and polyester-spandex panels
- 2 handwarmer pockets and 1 chest pocket
- Zippered pass through access inside both hand pockets
- Reinforced panels on shoulders and elbows for durability
- Back lumbar pocket spans across entire bottom

Sizes: Men's S-2X, see size chart A on p. 98

6R1-JA188 \$99.99



Light Olive

EXCLUSIVE ITEM



tested to work

Mascot® Naxos ¼ Zip Sweater

Pull out this sweater to block chilling wind, whether you're on or off duty.

- Cotton-acrylic blend
- Windproof lining
- Phone chest pocket with zip
- Sleeve pocket with hook-and-loop closure and pen holder
- Ribbed at neck, waist and cuffs
- Zip at neck with storm flap

Sizes: Men's S-3X

6R1-ST695 \$119.99

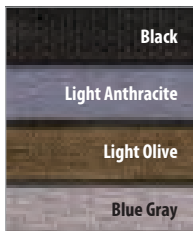

Charcoal

\$79⁹⁹

★ PROPPER™

PROPPER™ Tech Sweater

Full zippered sweater can be worn as a stand-alone or in the three-in-one Hardshell Parka (JX833, available online) as part of the system. Side zippers at the waist allow for quick retrieval of your sidearm.

- 100% polyester sweater fleece
- Slip-resistant fabric around shoulders
- 2 zip lower pockets; 1 zip chest pocket
- Full front zipper
- Side zippers at waist

Sizes: Men's S-5X, M-3X Lng, see size chart A on p. 98

6R1-SM573 \$79.99

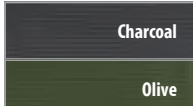

Ordering online? Use your **PROMOTIONAL CODE** from the back cover

800.477.7766 • galls.com

43

Adjust both sides to keep words or logo in the middle

Galls® Exclusive Armstrong Strap

GALLS®

Galls® Removable/Changeable Wrap Strap

Customize your strap with name, title or department.

- Strap personalization is always in the middle
- Strap adjusts for even hard to fit sizes

6R1-PES01 \$7.69

Insert end of strap into left slot

Insert opposite end of strap into right side slot

Ball Caps for

\$6⁹⁹

5.11

5.11 Tactical® Uniform Hat

Durable polyester-cotton twill construction, with a Teflon® coating to fight stains and water while you're out on the field.

- 5.78 oz, 65% polyester, 35% cotton twill
- Teflon® finish resists stains and water penetration
- Adjustable

Sizes: One size fits most

6R1-HW426 \$6.99

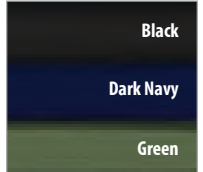

We Accept these Major Credit Cards



★ PROPPER™

PROPPER™ Foldable Patrol Cap

Foldable bill for compact storage.

- Nylon ripstop fabric
- Elastic headband

Sizes: S/M, L/XL, see size chart T on p. 99

6R1-HA551 \$9.99



Elbeco™ TEK3 Cap

The TEK3 series incorporates Nano fluid-repellent technology to keep you dry while maintaining natural breathability.

- Polyester-cotton twill
- Plain front and subdued logo at rear
- Adjustable back strap

Sizes: One size fits all

6R1-HA037 \$11.89

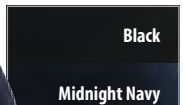

Five-Panel Cap Navy

Six-Panel Cap Dark Navy

GALLS®

Galls® Caps

Why settle for just any cap when you can get the cap that meets your needs? Choose a medium profile five-panel cap or lower profile six-panel cap. Choose soft cotton or polyester-cotton for a blend of durability and comfort. Five-panel is also available with a mesh back allowing air to circulate to keep you cool. All caps have plain fronts.

Colors: (HW310) all. (HW210, HW245, HW181) Black, Navy. One size fits most.

Customization: See options starting on p. 100

Five-Panel Medium Profile \$13.89

Polyester/Cotton Mesh 6R1-HW310

Cotton Twill 6R1-HW210

Six-Panel Low Profile

Polyester/Cotton 6R1-HW245 \$13.49

Cotton 6R1-HW181 \$13.89

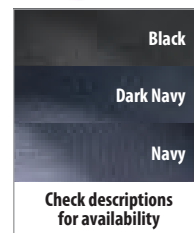

Black

GALLS®

Galls® 3X Dry Cotton Ball Cap

Galls most popular ball caps now made three times better with the revolutionary 3X Dry treatment, which repels water and stains on the outside.

- Cotton twill fabric
- Wicks moisture on the inside and absorbs quickly for a dry and comfortable wear all day
- Six-panel construction
- Plain front perfect for embroidery

Black. One size fits most. Customization: See options starting on p.100

6R1-HW561 \$15.29

Every Occasion



FLEXFIT

Flexfit® Performance Ball Cap

Lightweight fabric with the look and feel of wool.

- Polyester-spandex blend
- Hypoallergenic, moisture-wicking and superior drying with matching under-visor
- PermaCurv PE visor with eight rows of stitching
- Fused hard buckram front panels
- Mid-profile cap, 3¼" crown with six eyelets

Colors: Black, Dark Navy, Brown, Red. Sizes: S/M, L/XL, see size chart S on p. 99

6R1-HW682 \$15.99

Flexfit® Wooly Combed Twill Ball Cap

Six-panel, mid-profile, wool-like, texture-fitted cap

- Polyester, cotton and spandex blend
- Fused hard buckram front panels
- Silver under visor; rounded athletic shape forms to your head

Black, Dark Navy. Sizes: XS, S/M, L/XL, 2X, see size chart S on p. 99

6R1-HW679 \$16.29

Flexfit® V Flex Cotton Twill Ball Cap

A fitted cap with six panels for a mid-profile fit.

- Cotton-spandex blend
- Eight rows of stitching on a PermaCurv visor
- Fused hard buckram
- 3½" crown with silver under-visor

Colors: all. Sizes: S/M, L/XL, see size chart S on p. 99

6R1-HW729 \$15.99



5.11

Storm Gray

NEW

5.11® Tactical Caliber A Flex Cap

Light coverage with a conventional brim.

- Polyester-spandex
- Six-panel design
- Embroidered logo

Sizes: One size fits all

6R1-HD431 \$18.99



Blue

NEW

Under Armour® Freedom Cap

Slightly higher crown maintains shape.

- 96% cotton, 4% spandex
- HeatGear® sweatband wicks sweat and dries fast
- UA tactical logo; UA Freedom Initiative

Sizes: One size fits all

6R1-HD340 \$24.99



TRU-SPEC® Contractors Hat

Fight off the damaging rays of the sun with a UPF 50+ protected hat.

- Polyester stretch
- Moisture-wicking
- Antimicrobial
- Loop field above bill for emblem attachment

Sizes: One size fits most

6R1-HA013 starting at \$14.95+

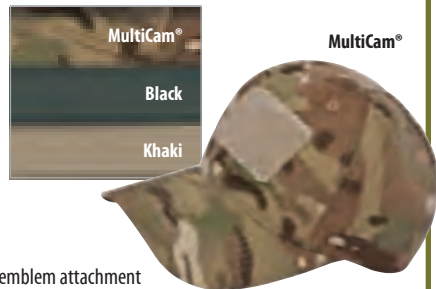

5.11

5.11 Tactical® Flag Bearer Cap

Show your patriotic side with this stylish alternative to everyday headwear.

- Flag design on the front panel

Sizes: One size fits all

6R1-HA859 \$16.99



5.11

5.11 Tactical® Downrange 2.0 Cap

Perfect cap for a day of target practice.

- Flex stretch fabric
- Structured seven-panel design
- Embroidered 5.11 front logo

Sizes: One size fits all

6R1-HD432 \$18.99



Oakley® SI Cap MK2 MOD 1 Mesh Hat

Features a front VELCRO® brand morale patch panel with subdued ellipse embroidery.

- Performance polyester fabrication
- O-hydrolix headband
- Unstructured, stretch fit

Sizes: One size fits most

6R1-HW168 \$28.00



Visit us online for pricing on additional options.

Ordering online? Use your **PROMOTIONAL CODE** from the back cover

800.477.7766 • galls.com

45

Training from TOMMIE COPPER™



TOMMIE COPPER™ Men's Compression

Ergonomically designed to provide support for muscles and joints. Gentle, effective compression allows for 24-hour use, even while asleep.

- PRO+IONIC™ copper, nylon and spandex fabric
- COOL COPPER™ technology provides advanced wicking that pulls moisture from the skin, keeping you dry and cool
- Naturally antibacterial and anti-odor

Colors: (UE595) Black, Slate Gray. (UN768) Black, Navy, Slate Gray, White. (UN769) Black, Slate Gray, White. (TS290) Black, White. Sizes: S-2X.

Description	Item	Price
Shorts	6R1-UE595	\$49.50
Omega V-Neck	6R1-TS290	\$49.50
Short Sleeve	6R1-UN768	\$49.50
Long Sleeve	6R1-UN769	\$59.50

Long Sleeve Compression
Black



Omega V-Neck
Slate Gray



Short Sleeve Shirt
Black



Long Sleeve Compression
Black

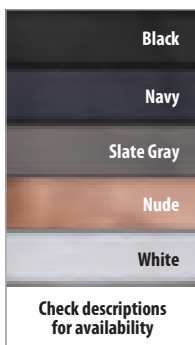

NEW

Full Finger



NEW

Fingerless



TOMMIE COPPER™ Vitality Gloves

Comfortable enough to wear while you're sleeping for 24/7 restorative relief.

- 86% polyester, 14% spandex with silicone palms
- CopperZnergy™ fabric for odor reduction
- COOL COPPER™ for moisture-wicking freshness

Colors: Black, Nude. Sizes: S-XL

\$29.50

Description	Item
Men's Full Finger	6R1-GL698
Women's Full Finger	6R1-GL704
Men's Fingerless	6R1-GL697
Women's Fingerless	6R1-GL699

Back Brace
Black



Men's Core Band
Black



TOMMIE COPPER™ Core Support

Muscle recovery with joint and pain relief.

- 86% nylon, 14% spandex
- Odor reduction

Colors: (UX921) Black. (UX920) Black, Nude.

Men's Comfort Back Brace: Relief for lower back with foam interior and adjustable VELCRO® brand strap.

6R1-UX921 \$69.50

Men's Core Compression Band. Relief for chest and back with double layer design for maximum support.

6R1-UX920 \$39.50

Breathable, Cool Comfort

Navy



TRU-SPEC® 24-7 Series Comfort T-Shirts (3 Pack)

Sweat-wicking fabric to keep you cool and dry, with a double-needle sport collar to prevent neckline from sagging.

- 100% ring-spun cotton
- Moisture wicking
- Double-needle sport collar
- Full-cut body

Colors: Black, Navy, White.

Sizes: S-3X, see size chart A on p. 98

6R1-TS735 \$19.95/3 pk

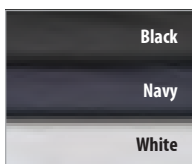

White



Long Sleeve

Black



★ PROPPER™

PROPPER™ T-Shirts

A clean, neat and professional appearance without sacrificing comfort. Combed jersey fabric keeps its shape.

- Cotton and polyester combed jersey
- Lay-flat crew neck collar
- Tagless labeling for comfort

Colors: (TS724) all. (TS791) Black, Navy, White. Sizes S-2X, see size chart A on p. 98

\$24.99/3 pk

Short Sleeve **6R1-TS724**

Long Sleeve **6R1-TS971**

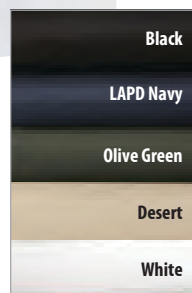

Men's
Navy



Women's
White



Navy



Red Kap® Performance T-Shirts

Constructed with a perfect fabric weight to hold up under tough work and wash conditions without being too heavy.

- Mesh fabric offers a more open knit pattern that allows for greater breathability and cooling
- Grid texture aids in minimizing dirt and snags
- Fabric accepts embroidery, heat seals and emblems

Sizes: Men's S-6X. Women's S-3X

\$17.29+

Men's **6R1-TS265**

Women's **6R1-TS266**

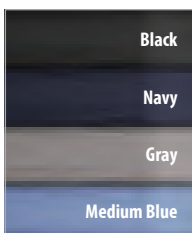

TRU-SPEC® Cordura® Baselayer Crew Neck T-Shirt

Cordura baselayer fabric dries faster than traditional cotton.

- No melt, no drip
- Abrasion resistance
- Ribbed knit collar with double-needle cover stitch
- Offset shoulder seam to minimize abrasion and seam stacking
- Flat seam construction on shoulders and sleeve set
- Double-needle cover stitch hem on sleeves and bottom

Sizes: S-3X, see size chart A on p. 98

6R1-UA775 \$19.95+

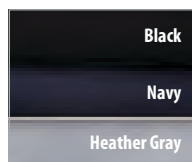

with Classic T-Shirts

Dark Navy



5.11

5.11® Tactical Series Utili-T Shirt

Extra-long tail keeps Utili-T shirt in place while moving.

- Cotton jersey fabric
- Moisture-wicking fabric
- No-roll, 1" high-density collar
- Tapered fit with printed tag

Sizes: S-3X, see size chart A on p. 98

6R1-UA615 \$34.99/3 pk

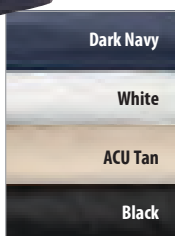

Khaki



★ PROPPER™

PROPPER™ System Tee

Elevates the traditional base layer to withstand excruciating heat.

- 100% polyester knit
- Lightweight mesh venting at high-heat areas
- Moisture wicking
- Dual layer fabric panels at high abrasion areas
- Extra zip pocket on left back hip for secure storage of accessories
- Offset shoulder seams prevent chafing when layering or wearing packs
- Contoured to the body for a tailored, base layer fit

Sizes: S-2X, see size chart A on p. 98

6R1-TS719 \$24.99

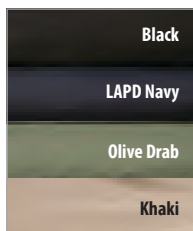

Front
Navy/Gold



LawPro®

LawPro® Security T-Shirt

Casual comfort for security personnel.

- Heavyweight cotton
- Front left chest (1" letters)
- Back (3" letters)

Sizes: M-3X, see size chart A on p. 98

6R1-TS769 starting at \$10.69+

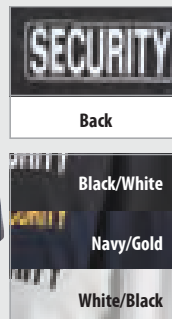

Long Sleeve
Navy

Short Sleeve
Black



Back

GALLS®

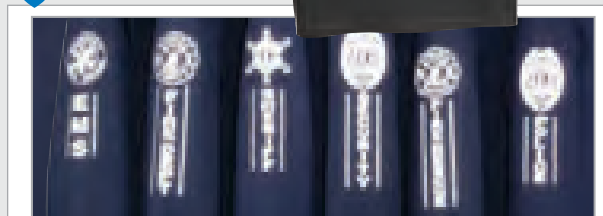

Long Sleeve T-shirt design offers 360 degree reflectivity with title down the sleeve

Galls® 360° Reflective T-Shirts

Wear a cotton T-shirt that helps you to be seen with 360° reflectivity. 500 candlepower reflective material on the left chest, back and both arms.

Colors: Black, Navy.

Titles: POLICE DEPT[®], SECURITY OFFICER, FIRE DEPT[®], FIRE RESCUE[®], EMS, SHERIFF'S OFFICE[®] Sizes: (TS506) M-3X. (TS241) M-2X, see size chart A on p. 98

Description	Item	Starting at
Short Sleeve	6R1-TS506	\$24.59+
Long Sleeve	6R1-TS241	\$31.99+

(X) Visit us online for restricted item info.

+ Visit us online for pricing on additional options.



**EXCLUSIVE
ITEMS**

With more attention to bike patrol these days, we wanted to develop bike apparel to better meet your needs. So we talked with professionals like you, then turned to one of the most trusted names in bike apparel to make it all happen.

The result: Mocean Tech® Apparel, a line of shirts, pants and outerwear designed to give you the features and quality you want at a budget-friendly price.



Black/
Black

Epaulets

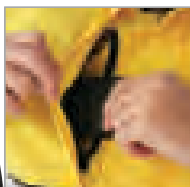

Chest pockets
in caped front have
side-zip opening



3M

Mocean Tech® Waterproof Bike Jacket with Zip-Out Liner

You'll be ready for any weather with this affordable jacket.

- Nylon shell with zip-out fleece vest liner
- 3M™ reflective tape around chest and back
- Pockets: 2 front slash; 2 chest zipper; 2 inside patch; 2 pen on each side of zipper
- Bi-swing back and caped back
- Underarm zips

Sizes: Men's (chest) S (35-37), M (38-40), L (41-43), XL (44-46), 2X (47-49). Customization: See options on p. 100

6R1-JA680 starting at \$124.99+

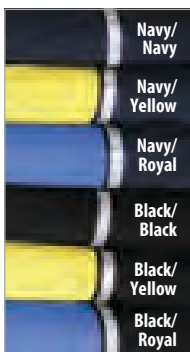

Navy/
Navy

Navy/
Yellow

Navy/
Royal

Black/
Black

Black/
Yellow

Black/
Royal



Navy
Solid
Plain



Royal/
Black
Two-Tone
Reflective



White
Solid
Reflective



Mocean Tech® Bike Polos

This amazing fabric includes moisture-wicking thermodynamic technology that keeps you cooler in summer and warmer in cooler weather. Choose from three styles: solid color plain, solid color reflective and two-tone reflective.

- Polyester-X-STATIC® silver nylon (natural and non-toxic)
- Reflective trim is made up of hash marks for comfort
- Fade resistance
- Antimicrobial and anti-odor features keep you fresh all day
- Double-needle stitching and reinforced placket
- Side vents
- Mic tabs on both shoulders and placket

Sizes: Men's S-3X. Customization: See options on p. 100

Description	Item	Starting at
Solid (Plain)	6R1-SR064	\$44.99+
Solid (Reflective)	6R1-SR065	\$46.99+
Two-Tone (Reflective)	6R1-SR066	\$58.99+



Visit us online for pricing on additional options.

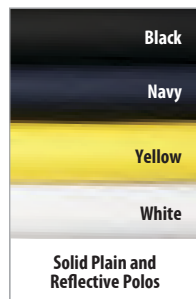

Black

Navy

Yellow

White

Solid Plain and
Reflective Polos

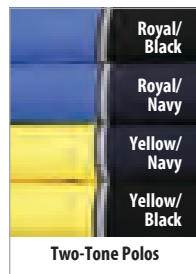

Royal/
Black

Royal/
Navy

Yellow/
Navy

Yellow/
Black

Two-Tone Polos



Yellow/
Black



Mocean® Waterproof Code-B Bike Jacket

Perfect for biking in rainy weather, with a waterproof shell that's remarkably breathable.

- 4.5 oz, Hytrel® with Teflon HT® waterproof, breathable shell
- Taped waterproof seams
- CoolMax® mesh liner to reduce moisture gain
- CoolMax® vent across back
- Pockets: 2 interior pen; 2 hand with zipper closures and storm flaps; 2 interior waist with zipper closures
- Asymmetrical Raglan Shoulders™ for ease of movement
- Cuffs with VELCRO® brand adjusters
- Underarm venting zip to adjust your air flow
- Sculpted shape for proper fit and speed; accommodates body armor

Sizes: Men's S-3X. Customization: See options on p. 100

6R1-JA378 starting at \$285.29+

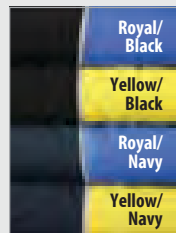

Royal/
Black

Yellow/
Black

Royal/
Navy

Yellow/
Navy

Maximum Mobility with Mocean Tech®



Mocean Tech Bike Pants starting at **\$47.99**



Mocean Tech® Bike Apparel

Fashioned from one of the most trusted names in bike apparel, these pants and shorts are based on suggestions from professionals.

- 4 oz, 100% three-ply, windproof Taslan® nylon
- 2 zippered back pockets; 2 zippered side cargo pockets with flaps; 2 pen pockets in each cargo pocket
- 1¾"W elastic waistband with drawcord
- 4 fabric-covered belt keepers with hook-and-loop closures
- Double-stitched seat for durability; zipper fly

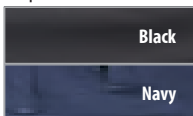

Bike Pants: These pants provide comfort and durability. They are packed with the details you asked for, like vented knees with stretch panels in the pants, plus pockets in the right places to keep your gear handy and secure.

Sizes: Men's S (28-30), M (31-32), L (33-35), XL (36-37), 2X (38-41), 3X (42-44). Inseams vary by size

Regular: Elastic cuffs and stirrups keep pants in place.

6R1-TR598 starting at \$47.99+

Zip-Off Nylon Pants: Zip-off pant legs for easy shorts conversion. Double-snap front and 9" zippered leg gussets. 9" inseam on shorts.

6R1-TR599 starting at \$63.99+

Zip-Off Stretch Pants: Polyester-Lycra® spandex four-way stretch material for optimum mobility. 2"W waistband. Zip-off pant legs for easy shorts conversion. 9" inseam on shorts.

6R1-TR600 starting at \$82.99+

Bike Shorts: Constructed of the same lightweight, windproof nylon as the pants and packed with just the features you want. Action leg side vents and 8" inseam.

Sizes: Men's S (28-30), M (31-32), L (33-35), XL (36-37), 2X (38-41), 3X (42-44)

Plain: Solid design for daytime wear.

6R1-TR601 starting at \$39.99+

Reflective: 3M® reflective piping along side seams. Increases visibility in low-light conditions.

6R1-TR602 starting at \$43.99+

Stretch: Polyester-Lycra® spandex four-way stretch material for optimum mobility. 2"W waistband with drawcord.

6R1-TR603 starting at \$57.99+



Regular Black

SAVE
Pants and shorts for one low price
Zip-Off Nylon Navy

Zip-Off Stretch Navy

Plain Navy

3M
Reflective Black



Black Stretch

Add 3M® reflective piping for only \$4 more

Ordering online? Use your **PROMOTIONAL CODE** from the back cover

800.477.7766 • galls.com

\$53²⁹

Gold/Black



LawPro® 3M

LawPro® Lightweight Bike Patrol Jacket

Removable polar fleece vest for additional warmth, and zippered pockets to secure valuables.

- Three-ply Taslan® nylon
- Removable polar fleece vest
- Scotchlite™ 3M™ reflective trim offers increased visibility
- Wind and water resistant
- 2 zippered pockets; reinforced mic tabs on shoulders

Sizes: S-6X, see size chart D on p. 98

6R1-JA023 starting at \$53.29+

[+ Visit us online for pricing on additional options.](#)

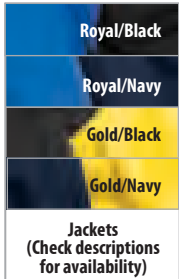

Jackets
(Check descriptions for availability)

Navy



LawPro®

LawPro® Deluxe Bike Patrol Pants

Tapered and zippered cuffs help prevent chain rub.

- Three-ply Taslan® nylon construction
- Lightweight and wind resistant
- Elastic waistband with drawstring and zipper fly

Colors: Black, Navy. Sizes: S-5X, see size chart A on p. 98

6R1-TR009 starting at \$37.99+

Navy



LawPro®

LawPro® Bike Patrol Shorts

Stay dry and comfortable on patrol.

- Three-ply Taslan® nylon construction
- Water resistant
- Moisture wicking
- 6 pockets
- Elastic waistband; zipper fly
- 9" inseam

Colors: Black, Navy. Sizes: S-5X, see size chart A on p. 98.

6R1-TR011 starting at \$28.99+



Pants easily convert to shorts



Black

LawPro®

LawPro® Zip-Off Bike Patrol Pants

Unzip and remove pant legs to convert to shorts.

- Nylon construction – durable, lightweight and comfortable
- 2 cargo, 2 side seam and 2 back pockets
- Tapered cuffs help prevent chain rub
- Elastic waistband with drawstring and zipper fly

Colors: Black, Navy. Sizes: S-5X, see size chart A on p. 98

6R1-TR015 starting at \$49.99+



Damascus® Half-Finger Bike Patrol Gloves

Protection for your hands. Reinforced for durability.

- Smooth Lycra® back
- Clarino® synthetic leather palms
- Foam padding in palms
- Terry cloth thumbs
- Adjustable closure at wrist

Black. Sizes: XS-2X, see size chart O on p. 99

6R1-GL226 \$13.19



Hatch® Full Finger Bike Patrol Gloves

Safeguard your hands with these durable yet comfortable gloves. Closed-cell foam is strategically distributed in the palm area for prolonged periods of gripping the handle bar.

- Airprene™ foam; silicone pads on fingertips
- Double-needle construction

Black. Sizes: S-2X, see size chart P on p. 99

6R1-GL052 \$31.49

Stay Visible in Low-Light Surroundings

Navy



5.11 3M

5.11® Bike Patrol Pants

Quickly convert your patrol pants into shorts with zip-off legs. The nylon-spandex blend is designed for bike patrol, with breathability and durability to withstand friction.

- Nylon-spandex blend
- Breathable, quick-dry, stretch fabric
- Fade and wrinkle resistance
- Roomy, thigh-mounted cargo pockets with internal organizers
- Non-slip shirt gripper at waist
- Adjustable belt loops
- Fully gusseted crotch for movement
- Articulated knees for prevention of bunching and chafing
- Zips off to shorts with a 9" inseam

Sizes: 28-44 even,
30-36 inseams

6R1-TT125 \$99.99

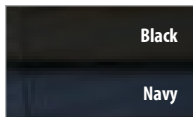

Black



5.11 3M

5.11® Bike Shorts

Patrol shorts with all the performance features you need.

- Lightweight nylon-elastane fabric
- Breathable, fade and wrinkle-resistant performance
- Roomy rear cargo pockets with internal secure pockets
- Non-slip waistband keeps your shirt tucked in
- VELCRO® brand adjustable belt loops
- Running crotch gusset for freedom of movement
- 9" inseam

Sizes: 28-44

6R1-TR885 \$59.99

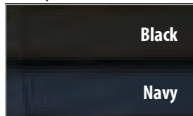

5.11 3M

5.11® Bike Patrol Polos

Polos provide a highly visible profile at night or in low-light conditions. Stay dry and fresh with moisture-wicking, antimicrobial finish; and cool with side vents.

- Polyester with 3M™ Scotchlite™ reflective material
- Moisture-wicking, antimicrobial finish
- Left chest dual compartment pen pocket
- Side vents and mic loops at the shoulders
- Additional coverage with a drop tail design

Tactical: A standard bike patrol polo with all the features you need for comfort, safety and function.

Sizes: XS-3X, see size chart A on p. 98

6R1-ST131 starting at \$49.99+

High-Visibility: Meets ANSI 107-2010 Class II standards. Drop tail design.

Yellow. Sizes: XS-2X, see size chart A on p. 98

6R1-ST888 \$59.99



High-Visibility Polo



Tactical
Black/Yellow

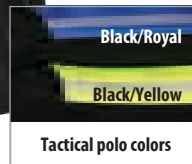

Tactical polo colors

5.11 3M

5.11® Bike Patrol Jacket

Designed for bike patrol officers and constructed with a polyester-spandex blend for warmth, breathability and waterproof protection.

- Polyester-spandex blend
- 3M™ Scotchlite™ reflective tape
- Waterproof and breathable
- Chest pocket and dual-entry hand pockets
- Elasticized back waistband for a neat appearance
- Sits at or above duty belt
- Seam-sealed construction
- YKK® Aquaguard® underarm zips for ventilation
- Badge tab and epaulets

Sizes: XS-3X, see size chart D on p. 98

6R1-JX074 \$169.99

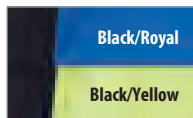

Black/Royal



Elbeco™ UFX Ultra-Light Color Block Response Polos

These performance polos feature eye-catching color blocks for a look that stands out. Moisture-wicking performance fabric keeps you dry and comfortable.

- 100% lightweight polyester
- Nano Moisture Wicking Technology
- Antimicrobial
- UV 40+ protection
- Pen pocket on sleeve
- Four-way stretch comfort
- Rib knit collar with stays to prevent roll up
- Tagless label
- Flex mesh underarm vents
- Extra-long body to prevent ride up
- Utility loop at base of placket
- Mic pocket

Colors: Royal Blue/Navy, Yellow/Navy. Sizes: XS-4X, see size chart F on p. 98

Description	Item	Starting at
Short Sleeve	6R1-SG732	\$49.99
Long Sleeve	6R1-SG733	\$59.99

Short Sleeve
Royal Blue/Navy



Long Sleeve
Yellow/Navy

EMS Trousers Resist Stains



Navy



Plain Navy

Right side cargo pocket comes with two added pockets: one for instruments and another for gloves

Left side cargo pocket provides ample room for essential supplies and equipment



Dickies® Comfort Waist EMT Pants

Dickies blends the durable construction of workwear with the function of EMT pants.

- Vat-dyed polyester-cotton twill
- StayDark® technology to reduce fading
- Permanent press postcured finish
- Fade, stain and wrinkle resistant
- Cargo pockets; tool pocket with heavy-duty snap loops
- Comfort waist; reinforced double knees
- Relaxed fit

Sizes: Men's 28-36 all, 38-56 even. Women's 4-24 even

Starting at \$39.99+

Men's 6R1-TT681
Women's 6R1-TT593

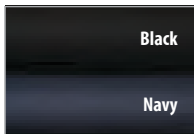

For a fraction of the cost, upgrade to 3M™ Reflective

Galls® EMS Pants

Hidden elastic waistband adjusts up to 3". Plus, there is extra room in the seat and the crotch, giving you the mobility you need in your demanding job. Stain-resistant fabric keeps you looking professional throughout your shift.

- Polyester-cotton blend
- Stain resistant
- Reinforced knees; accommodates up to 2¼"W belts; YKK® zipper

Sizes: Men's 30-54. Women's 6-22

Plain starting at \$41.99+

Men's 6R1-TR357
Women's 6R1-TR358

3M™ Reflective starting at \$48.29+

Men's 6R1-TR359
Women's 6R1-TR360

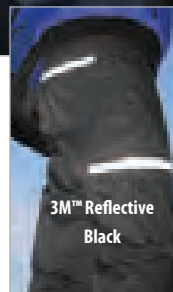
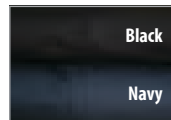

3M™ Reflective Black



Automatically Adjusting Waistband

Check out our emergency medical service gear and supplies, starting on p. 230.

and Keep You Looking Professional



Original

Cargo



LAPD Navy

NEW

5.11

5.11® Company Pants

Company Pants feature a gripper tape inside the waistband to keep shirt tucked in.

- Cotton twill
- Front pockets with Cordura® reinforced edge for clipping a knife
- Cargo pants with bellowed pockets
- Self-adjusting tunnel waistband with seven belt loops
- Gusseted crotch for durability and comfort
- Prym® snaps

Fire Navy. Sizes: Men's 28-54; inseam: 30, 32, 34, 36; 46-54 unhemmed

Description	Item	Starting at
Original	6R1-TR978	\$49.99+
Cargo	6R1-TR979	\$54.99+

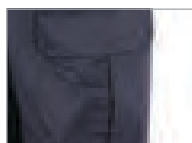

Cargo pockets provide handy access and more storage for your gear



Self-Adjusting Tunnel Waistband

★ PROPPER™

PROPPER™ Critical Response EMS Pants

Tactical-inspired design meets EMS functionality. Now also available in a polyester-cotton twill weave.

- 65% polyester, 35% cotton ripstop (TU327, TU326)
- Polyester-cotton twill weave (TJ164, TJ165)
- DuPont™ Teflon® protector repels stains and liquids
- Fade, shrink and wrinkle resistant
- 17 pockets, including D-ring with key silencer pocket
- Hidden slider waistband
- Extra-large belt loops for nylon duty belt
- Reinforced knees
- Zipper fly and snap closure

Sizes: Men's 30-44. Women's 2-20 even

\$44.99+

Men's Poly Cotton	6R1-TU327
Women's Poly Cotton	6R1-TU326
Men's Twill	6R1-TJ164
Women's Twill	6R1-TJ165

FREE Hemming

p. 100



Visit us online for pricing on additional options.

Ordering online? Use your **PROMOTIONAL CODE** from the back cover

Black

LAPD Navy

800.477.7766 • galls.com

67

First Responder Pants from the Brands



Ladies Choice features on p.73



Elbeco™ Ripstop ADU Trousers

Lightweight comfort and quick-dry performance with the durability of ripstop.

- 6.75 oz, 65% polyester, 35% cotton ripstop
- Nano Fluid Repellency Technology (liquids bead up and roll off)
- Notch front pockets with zipper security pocket and reinforced front pockets
- Low-profile cargo pockets with back bellows and internal compartments
- Triple-stitched crotch; double-thick seat and knees; articulated knees
- Ladies Choice fit for women

Midnight Navy. Sizes: (TT124) 28-38 all, 40-56 even. (TT121) 2-20. **FREE** hemming to 35", see p. 100

Description	Item	Starting at
Men's	6R1-TT124	\$60.99+
Women's	6R1-TT123	\$55.99+



Visit us online for pricing on additional options.



Right side cargo pocket has adjustable scissor straps

Midnight Navy

Left Side Cargo Pocket



Ladies Choice features on p.73



Elbeco™ TEK3 EMS Pants

The TEK3 is the next generation of TEK2 series, incorporating the same fabric and Nano Fluid Repellent Technology of Men's Essential Fit and Ladies Choice Fit.

- Polyester-combed cotton
- Vat dyed to retain color
- Rear utility pockets
- Covert stretch waistband
- Creaset front and back permanent creases
- Triple-stitched crotch prevents seam failure
- Double hook-and-eye closure in gun barrel finish
- Men's Essential Fit: lower rise and wider leg with front slight slope
- Ladies Choice Fit: contoured, natural waistband



Reflective strip can be exposed to help with visibility during night calls



Covert waistband provides up to 3" of additional room for comfort

Sizes: Men's 28-58. Women's 2-24

\$54.59

Men's	6R1-TR758
Women's	6R1-TR762

Black

Midnight Navy

You Know and Trust



5.11

5.11® EMS Pants

Fashioned after the legendary 5.11 Tactical Pants, for the professional who demands the best.

- 7.25 oz, fade-resistant polyester-cotton twill
- Teflon® treated for stain, soil and fluid resistance
- 8 pockets, including cargo and EMS specific pockets
- Cordura® nylon lined scissor/shears pocket
- Self-adjusting gripper waistband
- Gusseted crotch; 2 fabric layers in seat and knees
- Prym® snaps® and YKK zipper®; utility strap on rear

Sizes: Men's 28-54 (inseams 30-36" even). **FREE** hemming up to 34" for men's sizes 46-54, see p. 100. Women's inseams: 2-30¼", 4-30½", 6-30¾", 8-31", 10-31¼", 12-31½", 14-31¾", 16-32", 18-32¼", 20-32½" regular. For long, add 3" to inseam length

Starting at \$59.99+

	Polyester/Cotton Twill	TacLite Ripstop
Women's	6R1-TR557	6R1-TR730
Men's	6R1-TR556	6R1-TR729

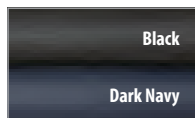

UNDER ARMOUR®

Under Armour® TAC Medic Pants

Loose fit and elastic waistband add comfort to UA's durable medic pants.

- Cotton-polyester ripstop fabric
- Storm DWR (Durable Water Repellent)
- Stain-resistant coating
- ArmourBlock® anti-odor technology
- Secure cargo pockets for shears, pen and tools
- Secured ankle pocket, dual knife/light pocket and hidden document pockets
- Reinforced crotch to prevent splitting

Dark Navy. Sizes: 30-44 (inseams 30-34" even). **FREE** hemming, p. 100

6R1-TU214 \$74.99



Flying Cross® EMS Freedom Flex Pants

Freedom Flex waistband offers a concealed stretch for automatic adjusting comfort.

- 65%, 35% polyester-cotton mini-ripcord
- Quarter top pockets with hidden vertical pocket with zipper closure inside left pocket
- High capacity cargo pocket on left side with mitered flap and VELCRO® brand closure
- Lower utility pocket on outside of cargo pocket with mitered flap and VELCRO® brand closure
- High capacity cargo pocket on right side with mitered flap and VELCRO® brand closure including a lower EMS utility pocket on outside of cargo pocket closure
- SuperCreases (LinTrak)
- Extra fabric built into knee for added reinforcement
- 1"W belt loops

Dark Navy. Sizes: Men's 28-54. Women's 2-24. **FREE** hemming, p. 100

Starting at \$82.99+

Men's **6R1-TT878**
Women's **6R1-TT879**

Job Shirts for Warmth Without the Weight



Stand-Up Collar



Galls Job Shirts

Our popular job shirt is now available with 3 classic collar styles: denim, microfleece, and stand-up collar!

- Long sleeve, with rib knit waist and cuffs
- Large pocket and keyholder on right side
- Anti-brass D ring on stand-up collar shirt, chrome metal D ring on the two original styles

Men's sizes: M-5X. See size chart B on p. 62.
Customization: See options on p. 88

Stand-Up Collar:

- 9.5 oz, 80% cotton/20% polyester low pill fleece
- Durable twill elbow-pads

6R1-ST135 starting at \$42.62+

Original Styles:

- 8 oz, 80% cotton/20% polyester low pill fleece
- Durable, fade-resistant denim elbow-pads

Original starting at \$30.99+

Denim Collar **6R1-SW663**
Microfleece Collar **6R1-SW664**



Microfleece Collar

Zips all the way up to keep your neck warm



Denim



TRU-SPEC® 24-7 Grid Fleece Job Shirt

Grid fleece interior increases breathability and moisture management without the added weight. Spandex allows the shirt to move with you.

- Polyester-spandex plaited grid jersey knit fabric
- Lined with grid fleece for increased breathability and improved moisture management

Navy. Sizes: XS-4X, see size chart A on p. 98

6R1-ST650 starting at \$49.95+



¼ Zip



Elbeco™ Job Shirts

Job Shirts offer color and shape retention with minimal shrinkage.

- Cotton-polyester fleece
- Tek3 elbow patches for excellent match, color retention and Nano Fluid Repellent Technology
- Dual fleece-lined side handwarmer pockets with internal storage pockets and a D-ring feature for key security
- Roomy chest pocket for a full-sized radio or a smaller object
- Mic pockets at both shoulders and center tab at bottom of front zipper; pen pockets on left sleeve
- Mic clip and sunglass options

Midnight Navy. Sizes: XS-4X Reg, L-4X Tall, see size chart F on p. 98

Starting at \$61.99+

¼ Zip **6R1-ST493**

Twill Collar **6R1-ST494**



UNDER ARMOUR®



Under Armour® UA Tactical Job Fleece

Appreciate the durable comfort of a cotton-blend fleece, paralleled by its streamlined style.

- 10.8 oz, cotton-polyester
- Mid-weight, 305g cotton-blend fleece; soft, brushed interior
- UA Storm technology repels water
- Front hand pockets; secure chest pocket; pen pocket on right sleeve
- Mic attachment points on shoulders

Dark Navy. Sizes: S-3X, see size chart M on p. 99

\$69.99

Men's **6R1-SM364**

Women's **6R1-SG738**



Visit us online for pricing on additional options.

5.11

5.11® Firefighter Job Shirts

These shirts were designed from input by firefighters just like you, with all the features you want most in a job shirt. Perfect for any public safety professional.

- Wrinkle, shrink, fade and stain resistant
- Multiple pockets allow for storage of various gear and equipment
- Chest Breakthrough™ pocket with VELCRO® brand divider lets you carry smaller objects

For sizing, see size chart B on p. 98. Customization: See options starting on p. 100

Storm ¼ Zip (water-resistant): Water-resistant STORM Cotton® fabric to help you stay dry.

Fire Navy. Sizes: Men's XS-3X

6R1-ST132 starting at \$72.99+

Original Styles (non-water resistant): Polyester-cotton fleece.

Colors: (Canvas) Fire Navy. (¼ Zip) Black, Fire Navy, Heather Gray. Sizes: Men's XS-3X Reg, XS-5X Tall

Starting at \$62.99+

¼ Zip Collar

Canvas Collar and Elbows

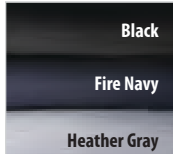
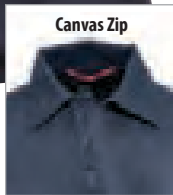

Check descriptions for availability

Storm ¼ Zip
Fire Navy



Long Sleeve
Shirt
Navy



Fleece Jacket
Black

5.11

5.11® FR Polartec

Highly breathable comfort seems to be woven into the very fibers of this crew, along with no-melt and no-drip FR performance. A proprietary blend of yarns lends itself to superb softness.

- NFPA 2112 and ASTM F1506/NFPA 70E compliant
- HRC2 ATPV 9.5 cal/cm2; Polartec® Power Dry® FR
- 6.4 oz, 45% rayon, 40% modacrylic, 15% para-aramid (patent-pending yarn blend)
- No-melt, no-drip technology

Sizes: S-2X, see size chart D on p. 98

Long Sleeve Shirt: Moisture-wicking fabric with flat-lock seam construction. Patent pending pen pockets on left sleeve.

6R1-FR048 \$99.99

Fleece Jacket: Wind-resistant fabric with a tapered fit.

Features 5.11's Hidden Document Pockets, inside storage pocket and zippered handwarmer pockets. Also includes mic clips on each shoulder, reinforced collar, shoulders and elbows, Prym® snaps and YKK® zippers.

6R1-FR049 \$269.99

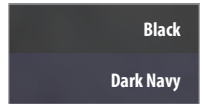

Reverses to fleece
job shirt



5.11

5.11® Taclite Reversible Company Jacket

Reverses from woven station jacket to a full-zip job shirt.

- Taclite polyester-cotton ripstop fabric
- Teflon® finish for stain protection
- Dual pen pocket
- Underarm zips for ventilation

Fire Navy. Sizes: S-4X, see size chart D on p. 98

6R1-JA187 starting at \$99.99+

5.11

5.11® Station Grip Gloves

Ready for work or play.

- Padded knuckles
- Four-way stretch back panel
- Reinforced palm and fingers
- Elastic wrist closure

Black. Sizes: S-2X, see size chart O on p. 99

6R1-GL460 \$26.99



Flame-Resistant Fabric Beats the Heat

NEW

Shirt
Navy



Jacket
Navy



Navy

Red

Check descriptions
for availability

Pants
Navy



Justin Work FR™ Flame-Resistant Performance Apparel

For over 130 years, Justin has been a trusted name in hardworking footwear. Now that same attention to detail that made Justin boots famous can be found in Justin FR workwear.

- NFPA 2112 Flash Fire, NFPA 70E Arc Flash Certified
- Flame-resistant material; ergonomically designed to move with you through any activity

Shirt: NFPA 70E, HRC 2 with 9.6 Arc Rating. 100% cotton with moisture-wicking properties. Dual pen/pencil pockets. Raglan sleeves and side gussets for increased range of motion. Colors: Navy, Red. Sizes: S-5X

6R1-SM544 \$87.95+

Jacket: NFPA 70E, HRC 2 with 16 Arc Rating. Wind Pro® fleece fabric with Polartec® for thermal insulation. Water repellent. Oversized hand pockets with FR Nomex® zipper closure. Adjustable three-piece hood and full FR Vision Nomex® zipper closure with mock neck collar. Colors: Navy. Sizes: XS-5X

6R1-JX805 \$249.95+

Pants: NFPA 70E, HRC 2 with 11.0 Arc Rating. 100% cotton ripstop. Pockets: Two deep front with leather trim, a third front inset, two cargo, two large back. Straight leg with bottom openings that fit comfortably over work boots.

Colors: Navy. Sizes: 28-50" (even only), Inseam length 30-36" (even only)

6R1-TU485 \$120.95+

NEW

Shirt



Jacket



Jeans



★ PROPPER™

PROPPER™ FR Apparel

With dual-hazard certification, PROPPER's FR line of apparel is engineered to endure the challenges you face on the frontlines.

- Dual-hazard (ARC rated, Flame Resistant) UL Certified to NFPA 2112, 70E
- ATPV (Arc Thermal Protective Value): 8.5 (Shirt); 51 (Jacket); 23 (Jeans)
- HRC-2

Shirt: FR 100% cotton twill. Pockets: dual chest with button closure and dual zippered document. Button down collar and adjustable cuffs. Bartack reinforcement in stress areas. Colors: Khaki. Sizes: Men's S-5X; L-3X Tall, see size chart A on p. 98

6R1-SJ064 \$59.99

Jacket: ATPV: 51, HRC-2. FR 88% cotton, 12% nylon canvas with built-in liner. Pockets: hand, hook-and-loop chest with pen pass through, dual internal. Adjustable cuffs and hook-and-loop lanyard opening on center back. Bi-swing back for mobility. Colors: Industrial Brown. Sizes: Men's S-5X, see size chart A on p. 98

6R1-JX876 \$149.99

Jeans: 100% cotton FR denim. Pockets: dual tool on right leg and hidden elastic tool loop in tool pocket on left thigh. Double-needle surge stitching with diamond gusseted crotch. Colors: Indigo. Sizes: Men's 30-44 even sizes (30, 32, 34, 36 inseam options); 28, 46-50 even sizes (37.5 unhemmed), see size chart A on p. 98

6R1-TJ051 \$64.99



Light Blue

Fashion Fit

Fashion Fit is consistent with the best brand in women's clothing: true to size, sharp in appearance and comfortable to work in. The pants are cut with plenty of room in the waist, hips and throughout. Uniformed women will no longer have to take a larger size than normal.



Flying Cross® Polyester/Cotton Shirts

The perfect shirt for those who want the comfort of cotton and the durability of polyester.

- Polyester and combed cotton
- Wrinkle resistant
- Pleated pockets with VELCRO® brand secured flaps
- Permanent collar stays
- Sewn-in military creases
- Full badge sling

Sizes: (SH020) M-5X. (SH018) 15-19½. (SH047, SH048) bust 32-46 even. Men's: See size chart K on p. 98. Customization: See options on p. 100

Short Sleeve starting at \$39.99+

Men's **6R1-SH020**

Women's **6R1-SH047**

Long Sleeve starting at \$44.79+

Men's **6R1-SH018**

Women's **6R1-SH048**

Flying Cross® Polyester/Cotton Pants

In addition to concise fit, these pants have Intelli-Dry and StainSmart® 3™ technology that repels liquids, wicks away moisture and releases stains with each wash.

- Polyester and combed cotton
- Intelli-Dry and StainSmart® 3™ technology
- Freedom Flex expandable hidden waistband; Tru-Grip waistband keeps shirt tucked in
- Lintrak permanent creases
- Matches Navy Blue Flying Cross shirts above
- Fashion Fit for women

Navy Blue. Sizes: Men's 28-38", 40-54" even. Women's 6-24, even only. **FREE** hemming, up to 35" for men, 32" for women, see p. 100

Starting at \$61.29+

Men's **6R1-TR650**

Women's **6R1-TR651**



Visit us online for pricing on additional options.

Ordering online? Use your **PROMOTIONAL CODE** from the back cover



Midnight Navy

Ladies Choice

Look for this symbol in women's apparel for these amazing features: Graded chest and waist dimension for flattering fit and increased movement; armhole and sleeve shaped for more comfortable fit and appearance; graded body length for less bulk; and increased hip sweep to fit woman's body shape.



Elbeco™ Polyester/Cotton Shirts

Elbeco Polyester/Cotton Shirts feature breathable, permanent Nano Fluid Repellent Technology to keep you dry and comfortable.

- Polyester-cotton poplin weave
- Nano Fluid Repellent Technology
- Built-in sunscreen of UV 40+ to protect the fabric from fading and you from the sun
- Vat-dyeing process for superior color retention
- Pleated pockets with hook-and-loop closure and pen/pencil slot
- Cross-stitched shoulder straps; permanent collar stays and extra-long tails
- Sewn-in creases for classic military look
- Ladies Choice for women in short and long sleeve

Sizes: (SH093) S-2X, see size chart K on p. 98. (SH095) neck/sleeve: 15-18/32; 15-18½/33, 34, 35, 36. (SR751, SR750) 28-48. Customization: See options starting on p. 100

Short Sleeve starting at \$42.99

Men's **6R1-SH093**

Women's **6R1-SR751**

Long Sleeve starting at \$48.99

Men's **6R1-SH095**

Women's **6R1-SR750**

Elbeco™ TEK3 Four-Pocket Trousers

The latest in design technology.

- Polyester-cotton stretch twill weave for comfort
- Nano Fluid Repellent Technology
- Outstanding color retention withstands repeated washings
- Rear utility pockets
- Covert stretch waistband and curtain
- Triple-stitched crotch to reinforce against seam failure
- Creaset front and back permanent creases offer a sharp look
- Men's "Essential Fit" maintains a slight slope on the front rise and a pattern waistband that includes a lower rise and wider leg; Ladies Choice for women

Sizes: Men's 28-58. Women's Sizes: 2-30. **FREE** hemming up to 34", see p. 100

\$52.99

Men's **6R1-TR593**

Women's **6R1-TR590**

Midnight Navy

Light Blue

White

Shirts



Black

Midnight Navy

Pants

800.477.7766 • galls.com

73

Easy-Care Station Uniforms



Midnight Navy

Midnight Navy

Medium Blue

Shirts



Light Blue

Navy

Navy

Light Blue

White

Shirts



Lion® Brigade Shirts

Panel front covers six buttons to prevent catching and snagging.

- Polyester and cotton twill fabric
- Wrinkle resistant
- 2 mitered breast pockets with button down flaps
- Left pocket flap has slot for pen and safety glasses
- Long sleeve has two-button cuff closure
- True yoke reduces weight and increases comfort
- Fuse-banded dress collar and cuffs stay straight and smooth

Colors: Midnight Navy, Medium Blue. Sizes: Men's XS-S Reg, M-4X Reg, Lng and XLng

Description	Item	Price
Short Sleeve	6R1-SR765	\$43.99
Long Sleeve	6R1-SR766	\$57.89+

Lion® Traditional Trousers

Easy-to-maintain trousers with a stain-release finish.

- Polyester and cotton twill fabric
- Top pockets with Lionwear™ pocketing
- 2 welt-style hip pockets, button closure on left
- Steel hook-and-bar waist closure; no-roll waistband with shirt grip
- Heavy ratcheting brass zipper

Midnight Navy. Sizes: Men's 28-52 Reg, 34-42 Lng. Women's 4-24 even. **FREE** hemming available up to 34" for men and 32" for women, see p. 100

\$61.99

Men's	6R1-TR888
Women's	6R1-TR889



Flying Cross® Cotton Station Shirts

Look neat and professional all shift long.

- NFPA Compliant 1975, 2004 Edition. ISO 9001: 2008 certified
- 100% cotton
- Pleated patch pockets; scalloped flaps with VELCRO® brand closures
- Convertible sport collar with permanent collar stays on short sleeve; banded collar on long sleeve

Made in the USA. Sizes: Men's (SH1137) S-3X. (SH1138) S-3X Reg and Lng, see size chart K on p. 98

Description	Item	Starting at
Short Sleeve	6R1-SH1137	\$61.99+
Long Sleeve	6R1-SH1138	\$69.59+

Flying Cross® Cotton Station Pants

These NFPA-approved pants give you the durability you need, with the softness of cotton.

- NFPA Compliant 1975, 2004 Edition. ISO 9001: 2008 certified
- 100% cotton
- Quarter top pockets; bartacked at stress points for durability
- Ban Rol® waist prevents it from rolling over belt, providing a neat appearance
- ¾" W belt loops

Navy. Made in the USA. Sizes: Men's 28-38, even and odd, 40-54 even. **FREE** hemming available up to 34", see p. 100

6R1-TR449 starting at \$67.59+



Visit us online for pricing on additional options.

NFPA Certified Stationwear



Workrite® Short Sleeve Fire Resistant Nomex® Shirts

These shirts live up to *NFPA 1975 station uniform standards* with Nomex fire-resistant fabric. The extra-long shirrtail, five military creases and double-stitched front plackets allow firefighters to look sharp at all times.

- Certified *NFPA 1975 station uniform standard*
- Nomex® fabric construction
- 2 breast pockets with hook-and-loop flaps
- Double-stitched front placket with heavy-duty snap closure and decorative melamine buttons
- Fire Chief: shoulder epaulets secured with melamine buttons

Sizes (chest): 38-54 Reg and Lng

Description	Item	Starting at
Firefighter	6R1-ZS781	\$111.69+
Fire Chief	6R1-ZV752	\$114.99+

Workrite® Fire Resistant Nomex® Pants

Fire-resistant protection along with a comfortable fit. These pants are triple stitched and feld-locked outer seams provide exceptional durability. Deep-inset and large rear welt pockets allow the transport of extra gear with ease.

- Certified *NFPA 1975 station uniform standard*
- Nomex® fabric construction
- 2 front deep-inset pockets; 2 large rear welt pockets, one with button closure
- Triple-stitched, feld-locked outer seams and seat seam; all other seams, including zipper area, are double stitched
- Industrial: full cut for extra room in the fit

Sizes: 28-56 even

Description	Item	Starting at
Firefighter	6R1-ZS778	\$109.99+
Industrial	6R1-ZS796	\$119.99+

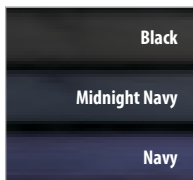

Flying Cross® Nomex® IIIA Shirts

Station style shirts combine the protection and the details you need in a uniform.

- *NFPA 1975, 2004 edition and ISO 9001:2008 Certified*
- Soil-release Nomex®
- 5 sewn-in creases: 2 front, 3 back
- Patch pockets with VELCRO® brand closure
- Seven-button placket front with concealed snap closure
- Symmetrically cross-stitched shoulder straps for neater appearance
- Optional badge tabs may be added

Navy. Sizes: (SR558) S-6X. (SR560) 28-52 even. (SR559) S-6X in Reg, Lng and XLng. (SR561) 32-52 Reg. Men's: See size chart F on p. 98

Short Sleeve starting at \$99.99+

Men's	6R1-SR558
Women's	6R1-SR560

Long Sleeve starting at \$130.79+

Men's	6R1-SR559
Women's	6R1-SR561

Flying Cross® Nomex® IIIA Pants

Nomex IIIA protection without sacrificing appearance or comfort.

- *NFPA 1975, 2004 edition and ISO 9001:2000 Certified*
- *Nomex IIIA certified for fire resistance*
- Soil-release Nomex®
- Lintrak creases for neater appearance
- Quarter top pockets; left hip pocket with security tab

Navy. Sizes: Men's 28-38 even and odd, 40-54 even. **FREE** hemming available up to 34", see p. 100

6R1-TR619 starting at \$123.69+

Reinforced for Reliable Wear

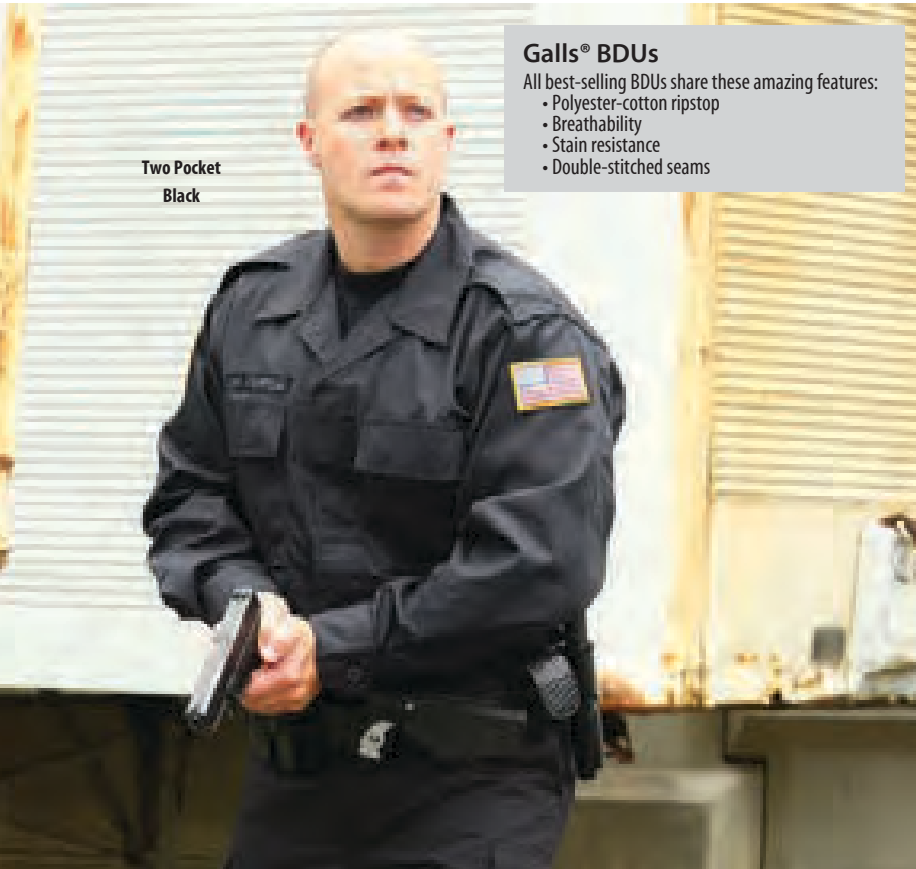

Two Pocket
Black

Galls® BDUs

All best-selling BDUs share these amazing features:

- Polyester-cotton ripstop
- Breathability
- Stain resistance
- Double-stitched seams



Two-Pocket
Navy

Four-Pocket
Black

Black

Navy

Brown

Olive Drab

Khaki



Galls® BDU Shirts

Tear-resistant polyester-cotton ripstop combines comfort and durable construction.

- Polyester-cotton ripstop blend
- Pen/pencil pocket
- Hidden buttons on placket
- Reinforced elbows and adjustable cuff tabs (long sleeve)

Two-Pocket: Large chest bellowed pockets with hidden buttons.

Colors: (Long Sleeve) all. (Short Sleeve) Black, Navy, Brown, Gray. Men's Sizes: (Short Sleeve) S-3X Reg. (Long Sleeve) S-5X Reg, S-3X Lng, see size chart G on p. 98

Starting at \$29.99+

Short Sleeve **6R1-SH115**

Long Sleeve **6R1-SH107**

Four-Pocket, Long Sleeve: Made to mil-spec MIL-C-44048G. Four large bellowed pockets with hidden buttons.

Colors: Black, Navy. Sizes: Men's S-5X Reg, S-3X Lng, see size chart G on p. 98

6R1-SH110 starting at \$29.99+

Galls® Six-Pocket Pants

Made to mil-spec MIL-T-44047E standards.

- Polyester-cotton ripstop blend
- Hidden buttons on back pockets secure items
- Reinforced knees and seat for durability
- Button fly

Sizes: Men's S-5X Reg, S-3X Lng, see size chart G on p. 98

6R1-TR077 starting at \$29.99+

FREE Hemming

p. 100



PROPPER™ BDUs

PROPPER BDUs have these great features:

- Construction meets mil-spec requirements
- Polyester-cotton ripstop
- Fade, snag, shrink and wrinkle resistant
- Fused pocket flaps
- Felled seams to eliminate fraying
- Double-reinforced stress areas

Sizes: Men's S-3X Reg, S-2X Lng.

See size chart A on p. 98

PROPPER™ BDU Shirts

Wear with BDU pants for a multi-use uniform.

- Button-down shoulder epaulets on two-pocket shirts
- Fused collar
- Adjustable sleeve buttons
- Four-pocket shirt with contoured body fit

Colors: (SH240) all. (SH239) Black, Navy, Khaki.

Customization: See options starting on p. 100

\$29.99

Two-Pocket **6R1-SH240**

Four-Pocket **6R1-SH239**

PROPPER™ BDU Pants

Authentic military cut in durable Battle Rip® fabric.

- Adjustable waist tab, button fly
- Bartacks for added durability
- Fused, knotted and tacked nylon drawstring leg closures

Colors: all

6R1-TR159 \$29.99

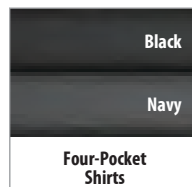
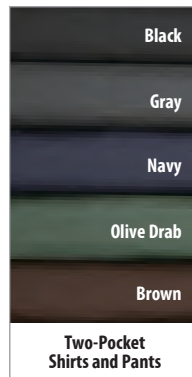

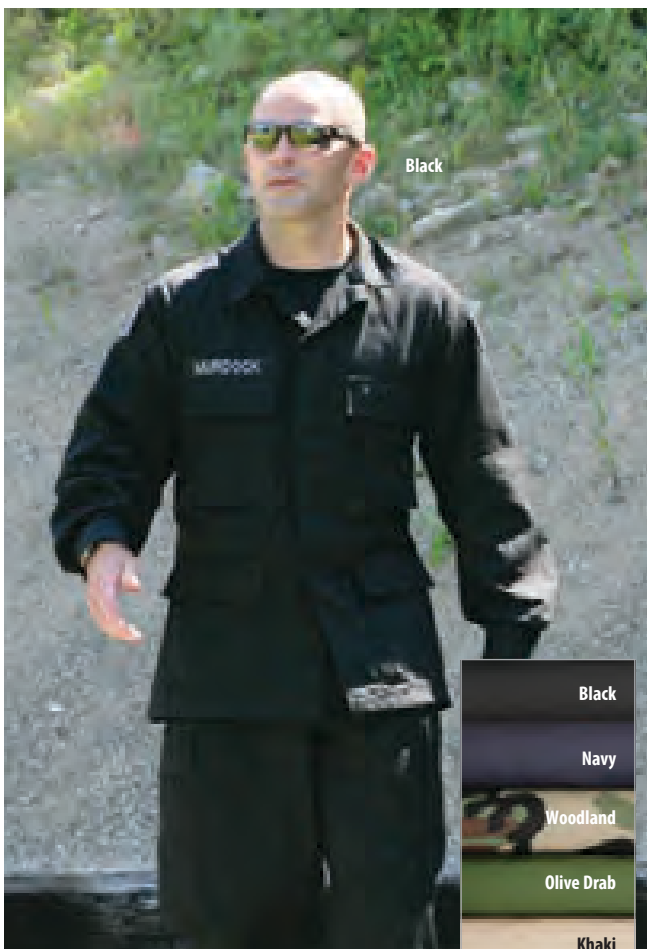

Black

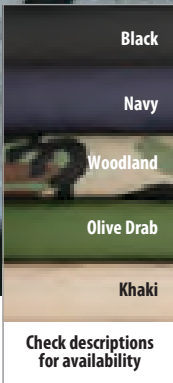

Tru-Spec® Four-Pocket BDU Shirts

Traditional Battle Dress Uniforms (BDUs) are combat tested for durability.

- Made to mil-spec MIL-C-44048G standards
- 2 large chest and bellow pockets to hold more gear
- Double-stitched seams and reinforced elbows

Colors: (SH108) Navy, Black, Woodland. (SH109) all. (SH956) Navy, Black, Khaki. Men's Sizes: S-3X Reg, S-2X Lng, see size chart A on p. 98. Customization: See options starting on p. 100

Cotton Polyester Twill: Cotton-polyester twill is medium weight and wind resistant.

6R1-SH108 starting at \$36.79+

Cotton Ripstop: Lightweight, breathable and tear-resistant cotton ripstop.

6R1-SH109 starting at \$37.49+

Polyester/Cotton Ripstop: Durable 65% polyester, 35% cotton ripstop.

6R1-SH956 starting at \$38.99+

Tru-Spec® BDU Six-Pocket Pants

Designed for action with reinforced knees and seat, extra room in thighs.

- Made to mil-spec MIL-T-44047E standards
- Choose your fabric: Cotton-polyester twill is medium weight and wind resistant; cotton ripstop is lightweight, breathable and tear resistant
- Waist tabs, drawstring bottoms and button fly

Colors: (TR075) Navy, Black, Woodland. (TR076) Navy, Black, Woodland, Khaki. Sizes: S-4X, see size chart A on p. 98

Starting at \$36.39+

Cotton Polyester Twill **6R1-TR075**
Cotton Ripstop **6R1-TR076**

NEW

EXCLUSIVE COLORS

Shirt
Gray



Combat Shirt
Navy



Pants
Black



Tru-Spec® Urban Force

Less military look but with combat-worthy function.

- 65%, 35% polyester cotton ripstop
- 60% nylon, 40% jersey knit body on Combat Shirt with polyester cotton ripstop sleeves
- Elbow pad inserts on shirts; kneepad inserts on pants

TRU Shirt: Zippered with hook-and-loop closure for smooth uniform appearance. Sleeve and chest pockets. Adjustable cuffs and collar (includes hook-and-loop name tape kit).

Sizes: XS-XL Reg, S-XL Lng, S-XL Short, see size chart A on p. 98

6R1-SJ233 \$54.95+

Combat Shirt: Quarter-zip with a contoured torso for athletic fit. Sleeve pockets. Adjustable cuffs and underarm gusset, with mesh side panels for ventilation.

Sizes: XS-3X Reg, M-2X Lng, see size chart A on p. 98

6R1-SJ232 \$54.95+

TRU Pants: Twelve-pocket design with comfort fit slider waistband and gusseted crotch. Hemmed bottom with internal button holes for optional drawcord.

Sizes: XS-5X Reg, SL-3X Lng, S-XL Short, see size chart A on p. 98

6R1-TJ128 \$54.95+

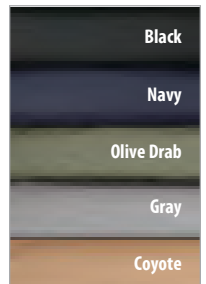

+ Visit us online for pricing on additional options.

Combat-Ready



Navy



Shirt
MultiCam®



Short Sleeve
Olive Drab



Long Sleeve
Olive Drab



Pants
Navy

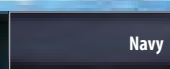

Navy

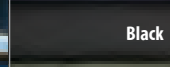

Black

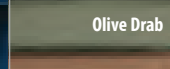

Olive Drab



Coyote

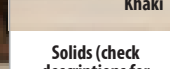

Khaki

Solids (check descriptions for availability)

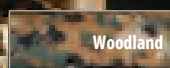

Woodland

MultiCam®

Multi-Colors (check descriptions for availability)

NEW
SHORT SLEEVE



TRU-SPEC® TRUs

Loosely based off the U.S. military ACU, but goes well beyond spec with dozens of durability and performance enhancements.

- 65% polyester, 35% cotton ripstop
- 60% nylon, 40% jersey knit body on Combat Shirts with polyester cotton ripstop sleeves
- Hook-and-loop closures

See size chart A on p. 98. Customization: See p. 100

Tru Shirts: Mandarin collar can be worn down or up to protect your neck and keep out debris.

- Zippered front with hook-and-loop closure
- Sleeve and chest pockets
- Reinforced external elbow pockets for pad inserts

Colors: Black, Digital Desert, Digital Woodland, Khaki, MultiCam, Midnight Navy Digital, Navy, Olive Drab, Tan. Sizes: Men's S-XL Reg, M-XL Lng

6R1-SH1062

Solid Color **starting at \$41.95+**

Multi-Color **starting at \$54.95+**

Combat Shirts: Reduce the severity of burns.

- No Melt, No Drip Cordura® brand base layer
- Breathable and moisture wicking
- Zippered sleeve storage pockets
- Anti-abrasion padded elbow patch; glint tape holder

Sizes: Men's S-3X Reg, M-2X Lng

Description

Description	Item	Starting at
NEW Short Sleeve	6R1-SJ308	\$48.95+
Long Sleeve	6R1-SR586	\$49.95+

Pants: Extra-deep front pockets with reinforced external pockets for kneepads.

- Drawstring waist with button fly
- 1" W belt loops
- Improved "stay tied" drawstring leg ties

Colors: Black, Digital Woodland, Khaki, MultiCam®, Navy, Olive Drab, Tan. Sizes: Men's S-XL Reg, M-XL Lng

6R1-TR425

Solid Color **starting at \$41.95+**

Multi-Color **starting at \$54.95+**

[+](#) Visit us online for pricing on additional options.

FREE Emblem Application

Our uniform experts will apply your emblems for **FREE**, at the time of purchase, to almost any garment you purchase from us.

Gear is Ready for any Mission



Shirt
MultiCam®

Combat Shirt
Black

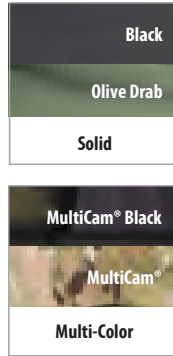

Black



TRU-SPEC® Xtreme Nyco TRUs

Xtreme™ TRUs (Tactical Response Uniforms) feature dozens of enhancements — including SuperFabric® durability, storage pockets and ripstop fabric.

Sizes: XS-5X Reg, S-XL Short, S-3X Lng, see size chart A on p. 98

Xtreme Nyco Shirts

Designed for warriors who know how to get the job done. Tough enough to meet all of your technical missions.

- Cotton-nylon Cordura® baselayer body
- Cordura® nylon-cotton ripstop sleeves
- Tri-pocket with document window flap, hook-and-loop closure and 3 exterior pen/pencil slots
- Mandarin collar can be worn up or down
- Articulated SuperFabric® elbows

TRU Shirts: Bellowed chest pockets with inverted pleat, hook-and-loop closure and hidden front zipper pocket.

TRU Combat Shirts: Offset shoulder seams to minimize abrasion and seam stacking under vests and body armor. Angled cuff for added wrist/hand protection.

Description	Item	Starting at
TRU Solid Colors	6R1-SG477	\$89.95+
Combat Solid Colors	6R1-SG479	\$89.95+
TRU Multi Colors	6R1-SG495	\$99.95+
Combat Multi Colors	6R1-SG494	\$99.95+

Xtreme Nyco Pants

- Cordura® nylon-cotton ripstop
- Pockets: deep front, hidden handcuff key, 2 knife/ accessory and 2 bellowed cargo pockets
- Comfort fit slider waistband
- Diamond shaped gusseted crotch
- Articulated SuperFabric® knees

Description	Item	Starting at
Solid Colors	6R1-TT320	\$89.95+
Multi-Colors	6R1-TT366	\$99.95+

Olive Drab



UNDER ARMOUR®



Under Armour® Tac Combat Shirt

Combat-worthy shirt, with a ripstop upper for durability and Storm I technology for water-resistant protection.

- Body: 100% charged cotton
- Upper: 100% polyester ripstop
- Storm I technology
- Water resistant
- Secure shoulder pockets with 4x4 hook-and-loop patching

Sizes: S-3X

6R1-SM258 \$74.99

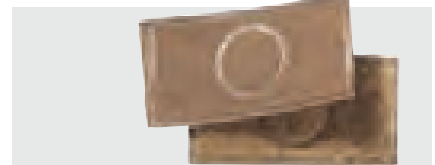
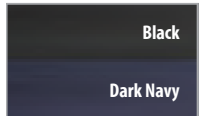

Coyote

The Fighter Design Silencer Kit

Silencer Kit recognizes the importance of stealth for tactical team members in the military and law enforcement. That is why we designed a silent magnetic alternative to the traditional hook-and-loop closures. Just attach straight over your regular VELCRO® brand fastener. No sewing needed.

- Attaches to any VELCRO® brand fastener and eliminates noise
- VELCRO® brand fastener
- Strong neodymium magnets
- Sonic welded construction for strength and durability

1"H x 1½"W, 1"H x 2"W

6R1-UA703
\$14.49/4 pk

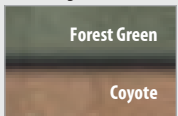

5.11® TDUs Repel Stains and Soil



Standard TDU
Black

Standard

5.76 oz, 65/35 poly/cotton twill fabric for superior durability and comfort

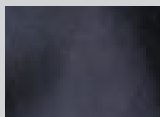

Taclite

4.4 oz, poly/cotton ripstop fabric

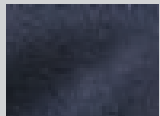

Stryke TDU

4.84 oz, Flex-Tac® mechanical stretch fabric for durability and performance

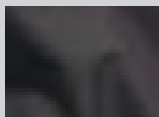

Black

Dark Navy

TDU Green
(Rapid Assault Shirt)

MultiCam®

Woodland

Storm Gray

TDU Khaki

Khaki

In Stock
(check descriptions
for availability)

Brown

TDU Green
(Standard Shirts)

TDU Khaki

Factory Delivered
(check descriptions
for availability)

5.11

5.11® TDUs

- Teflon® finish repels moisture, stains and dirt
- High-stress areas are triple stitched and bartacked

5.11® TDU® Shirts

5.11's proprietary fabric resists scuffs, abrasions and tears.

- Ripstop fabric
- Teflon® finish repels moisture, stains and dirt
- Reinforced elbows

Sizes: Men's S-4X, see size chart H on p. 98

Ripstop Long Sleeve: Polyester-cotton blend. 5.11's Hidden Document Pockets, two patch pockets and a pen pocket. Bi-swing shoulders.

Colors: Black, Dark Navy, TDU Green, MultiCam®, TDU Khaki, Woodland

6R1-SH801 starting at \$49.99+

Taclite®: Lightweight polyester-cotton fabric with 5.11's Hidden Document Pockets. Bi-swing shoulders

Colors: Black, Dark Navy, TDU Green, Storm Gray, TDU Khaki

Starting at \$49.99+

Short Sleeve **6R1-SH697**

Long Sleeve **6R1-SR758**

Stryke™ Long Sleeve: Flex-Tac™ stretch. Zip front with adjustable collar and cuffs. Chest and sleeve pockets. Badge tab holder with loop patch platform and epaulet kit.

Colors: Black, Dark Navy, TDU Green, Storm Gray, TDU Khaki

6R1-SG166 starting at \$79.99+

Rapid Assault Shirt: Moisture-wicking polyester/cotton/spandex knit. Large shoulder pockets and dual loop patches. Colors: Black, Dark Navy, TDU Green, MultiCam®, Storm Gray, TDU Khaki. Sizes: S-3X regular, see size chart D on p. 98

6R1-SR653 starting at \$59.99+

5.11® TDU Pants

5.11's exclusive fabric resists scuffs, abrasions and tears.

- Polyester-cotton ripstop
- Teflon® finish repels moisture, stains and dirt
- Cargo pockets; adjustable waist
- Double-thick knees; blousing straps

Sizes: Men's S-3X Regular, S-2X Long; Women's 2-20, see size chart H on p. 98

Standard: Polyester-cotton fabric. Backup Belt System™ carrier to facilitate attachment of pouches.

Colors: Men's Black, Dark Navy, TDU Green, TDU Khaki, Brown, Woodland, Khaki. Women's Black, Dark Navy, TDU Green

Starting at \$49.99+

Men's **6R1-TR336**

Women's **6R1-TR627**

Taclite®: Pockets for kneepads (sold separately).

Colors: Black, Dark Navy, TDU Green, Storm Gray

6R1-TR643 starting at \$49.99+

Stryke™: Flex-Tac™ stretch.

Colors: Black, Dark Navy, TDU Green, Storm Gray, TDU Khaki

6R1-TT348 starting at \$79.99+



Visit us online for pricing on additional options.



Desert

NEW
COMBAT SHIRT

Navy



**NEW Vertx® 37.5™
Combat Shirt**

Built to withstand tough treatment, double-reinforced and double-articulated elbows handle any wear, tear and fading incurred from crawling, shooting, reaching and climbing.

- Ripstop cotton sleeves
- 37.5 Active Particle Technology™ in the torso captures and releases moisture vapor, maintaining the body's optimal relative humidity of 37.5% and core body temperature of 37.5 degrees Celcius
- Dual loop VELCRO® brand bicep pockets and pen pocket
- Quarter-zip suede collar
- Double-reinforced, double-articulated elbows

Colors: Black, Navy, Smoke Gray, Kryptek, Olive Drab, Desert Tan.
Sizes: S-2X

6R1-SR400 \$89.95+

Vertx® Phantom OPS Pants

Lightweight mobility and functional storage in a slim-line profile. Knee, waistband, crotch and hip design offers an ideal balance of comfort, mobility and fitness.

- Polyester-cotton mini ripstop
- Pockets: cargo; bonus interior; dual concealed zipper

Colors: All. Sizes: Men's 28-42 (30, 32, 36" inseam), 32-42 (34" inseam), 44 (30, 32, 34, 44-46" inseams unhemmed)

6R1-TR746 \$59.95+



Handles Wear and Tear



Navy



Galls® G-Force Tactical Shirts

Look neat and professional all day long.

- Polyester-cotton twill
- 5 sewn-in creases (2 in front, 3 in back)
- Convertible sports collar on short sleeve and banded collar on long sleeve
- 2 pleated pockets with pencil slot on left pocket
- Sewn badge tab on left chest
- Extra-long shirt tails

Sizes: Men's S-5X, see size chart K on p. 98.
Customization: See options starting on p. 100

Description	Item	Starting at
Short Sleeve	6R1-SH614	\$45.19+
Long Sleeve	6R1-SH615	\$50.39+

Galls® G-Force Tactical Pants

Pants come with a comfortable fit, especially in the seat and crotch areas.

- Polyester-cotton twill
- 2 SAP pockets for batons, flashlights and more
- 2 cargo pockets with inner and outer compartments
- 2 back pockets with button tabs
- Brass YKK® zipper fly with auto-lock closure
- Crushproof hook-and-eye closures

Sizes: Men's 28-60. Women's 4-28. **FREE** hemming, p. 100

Starting at	Item
\$52.49+	6R1-TR363
Men's	6R1-TR363
Women's	6R1-TR364

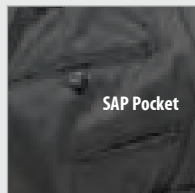
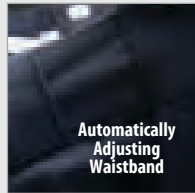
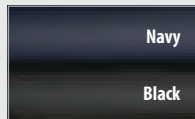

Ordering online? Use your **PROMOTIONAL CODE** from the back cover

800.477.7766 • galls.com

Quick-Dry Performance from Elbeco®



Black

Ladies Choice features on p. 73



Midnight Navy

Midnight Navy

Black

Brown

Olive Drab

Check descriptions for availability



Liquids roll off with Nano Fluid Repellent Technology



Patent pending flex underarm vent for body heat ventilation

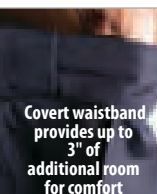

Covert waistband provides up to 3" of additional room for comfort



Reflective strip can be exposed to help with visibility during night calls



Learn more about Ladies Choice features on p. 73



Elbeco® Ripstop ADUs

Elbeco's ADUs offer lightweight polyester-cotton comfort and quick-dry performance with the durability of ripstop. Liquids bead up and roll off with Nano Fluid Repellent technology.

Shirts

- Polyester-cotton ripstop
- Nano Fluid Repellent Technology
- Dual pleated chest pockets with hidden top and side hook-and-loop closure storage options; pen openings with low-profile back bellows for increased easy access storage
- Opening in left pocket flap to accommodate pen or on-body camera clips
- False button front placket with hidden nylon zipper closure
- Flex mesh underarm vents for body heat ventilation and increased range of motion
- Dual comms wire access openings in side seams to keep wires out of the way

Colors: Black, Midnight Navy, Khaki. Sizes: (SR319, SR292) S-4X, (SR322) 15½-18½/33, 15½-20/35, 16½-20/37 (SR341) S-XL.

Short Sleeve \$48.99
Men's **6R1-SR319**
Women's **6R1-SR292**

Long Sleeve \$52.99
Men's **6R1-SR322**
Women's **6R1-SR341**

Trousers

- Polyester-cotton ripstop
- Nano Fluid Repellent Technology
- Notch front pockets with zipper security pocket and reinforced front pockets
- Low-profile cargo pockets with back bellows on each leg feature internal compartments
- Triple-stitched crotch prevents blowouts
- Double-thick seat and articulated knees provide protection and durability for optimum wear and usage

Colors: (TT122, TT121) Black, Midnight Navy, Khaki. Sizes: (TT122) 28-38 all, 40-56 even. (TT121) 2-20 even. **FREE** hemming to 35", see p. 100

\$55.99+
Men's **6R1-TT122**
Women's **6R1-TT121**

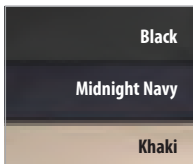

Elbeco® TEK 3 Tactical Shirts

The same superior twill fabric and Nano Fluid Repellent Technology as TEK2, with even more storage and functionality.

- Polyester-cotton stretch twill weave for comfort
- Nano Fluid Repellent Technology
- Utility chest pockets
- Flex mesh underarm vents
- Stitched-in creases
- Functional epaulets; wire access openings for electronics

Colors: (SH718) Midnight Navy, Black, Brown. (SH720) Midnight Navy, Black, Brown. Women's in Midnight Navy. Sizes: (SH718/neck) S-4X. (SH717) 30-52. (SH720/neck/sleeve) 14.5-17½/33; 15½-17½/35; 16½-17½/37; 18½-20/35; 18½-20/37; 22/37. (SH719) 30-54. Men's, see size chart K on p. 98

Short Sleeve \$52.49
Men's **6R1-SH718**
Women's **6R1-SH717**

Long Sleeve \$57.79
Men's **6R1-SH720**
Women's **6R1-SH719**

Elbeco® TEK 3 Tactical Cargos

A professional look with the added benefit of moisture management and plenteous storage.

- Polyester-cotton stretch twill for a comfort fit
- Nano Fluid Repellent Technology for dryness
- Dual access cargo pocket patterned with 3M™ brand reflective trim and rear utility pockets for gear
- Covert stretch waistband and curtain
- Triple-stitched crotch
- Double zipper and hook-and-eye closures for a reinforced fit

Colors: all. Sizes: Men's 28-50 unhemmed, 52-58. Women's 02-24. **FREE** hemming, up to 35", see p. 100

\$68.99
Men's **6R1-TR747**
Women's **6R1-TR592**

Repels Stains and Soil

5.11

5.11® PDU's

- Teflon® finish repels moisture, stains and dirt
- Superior fade-resistant technology

5.11® PDU Shirts

5.11's Patrol Duty Uniform (PDU) shirts are packed with functional features and maintain a professional appearance.

- Bi-swing shoulders; 2 chest pockets
- Permanent creases; adjustable cuffs
- Hidden front YKK® zipper closure; epaulets; badge tab
- Camera/radio loop; mic wire pass through
- Class B features hidden document pockets

Colors: (PDU) Black, Midnight Navy, Silver Tan, White. (PDU Stryke) Black, Midnight Navy. Sizes: Men's S-2X Regular, L-2X Long. Women's XS-XL Regular, M-XL Long. For sizing, visit galls.com

Twill: 65% polyester, 35% cotton twill. Teflon® treated for stain and soil resistance.

Class A starting at \$51.99+

	Short Sleeve	Long Sleeve
Men's	6R1-SR634	6R1-SR635
Women's	6R1-SR638	6R1-SR639

Class B starting at \$51.99+

	Short Sleeve	Long Sleeve
Men's	6R1-SR611	6R1-SR612
Women's	6R1-SR613	6R1-SR614

Stryke: 80% polyester, 20% cotton with Flex-Tac™ mechanical stretch for mobility. Teflon® finish for stain and soil release.

Class A starting at \$79.99+

	Short Sleeve	Long Sleeve
Men's	6R1-SG278	6R1-SG275
Women's	6R1-SG162	6R1-SG164

Class B starting at \$79.99+

	Short Sleeve	Long Sleeve
Men's	6R1-SG277	6R1-SG274
Women's	6R1-SG163	6R1-SG165

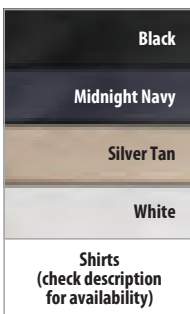

5.11® PDU Pants

Comfort and functionality with a professional appearance.

- Class B pants include cargo pockets on each thigh
- Stryke pants also include flashlight pockets at the back thigh
- Self-adjusting comfort waist with xtra-wide gripper waistband
- Flat front and permanent creases

Colors: (PDU) Black, Midnight Navy, Brown, Sheriff Green; (PDU Stryke) Black Midnight Navy. Sizes: Men's 30-44 even. Women's 2-20 even. **FREE** hemming to 35", see p. 100

Twill: 7.25 oz, 65% polyester, 35% cotton twill. Teflon® treated for stain and soil resistance.

starting at \$51.99+

	Class A	Class B
Men's	6R1-TR703	6R1-TR666
Women's	6R1-TR706	6R1-TR667

Stryke: 80% polyester, 20% cotton with Flex-Tac™ mechanical stretch for mobility. Teflon® finish for stain and soil release.

starting at \$79.99+

	Class A	Class B
Men's	6R1-TT358	6R1-TT350
Women's	6R1-TT352	6R1-TT351

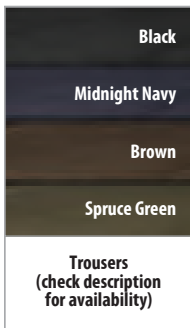

5.11

PDU

5.76 oz. 65/35 poly/cotton twill fabric that provides superior durability and comfort.

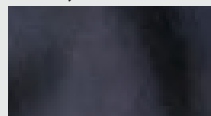

Stryke PDU

4.84 oz. Flex-Tac® mechanical stretch fabric for outstanding durability and performance.

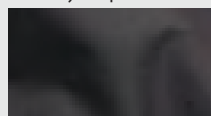

 Visit us online for pricing on additional options.

Ordering online? Use your **PROMOTIONAL CODE** from the back cover

800.477.7766 • galls.com

Professional, Affordable Class A Apparel



Shirts starting at
\$17.99

Light Blue

Black



LawPro® Polyester Uniform Shirts

Built tougher to hold up longer in working conditions.

- Pleated patch pockets with scalloped flaps and a placket front for a crisp, professional image
- Pen slot on left pocket
- Permanent collar stays
- 2-button adjustable cuff (long sleeve only)
- Safety-stitched side seams for extra strength
- 5 sewn-in creases
- Button-down epaulets include mic attachment

Sizes: Men's XS-6X, see size chart A on p. 98

Solid Color Description	Item	Price
Short Sleeve	6R1-SG107	\$17.99
Long Sleeve	6R1-SG108	\$18.99

Two-Tone Description	Item	Price
Short Sleeve	6R1-SR324	\$18.99
Long Sleeve	6R1-SR325	\$19.99

LawPro® Polyester Twill Four-Pocket Trousers

Trousers stand firm with bartack reinforcements at all stress points for durable, daily wear.

- Polyester fine line twill
- Back pocket interlinings for a smooth look
- Gripper waistband to keep shirt tucked in
- Bartack reinforcements

Colors: Men's all. Women's Black, Midnight Navy, Gray. Sizes: Men's 28-66 unhemmed; 30-34 hemmed. Women's 6-24. **FREE** hemming to 35", see p. 100

Starting at \$19.99

Men's **6R1-TT091**
Women's **6R1-TT826**

LawPro® Pre-Striped Fine Line Twill Trousers

- Ready to ship today – no alteration delays.
- Pre-striped in our most popular combinations

Colors: Midnight Navy available with Gold Nylon, Light Blue Cloth, French Blue Cloth and Gray Cloth striping; Black available with Gray Cloth striping. Sizes: Men's waist 28-38, 40-62 (even)

6R1-TT103 \$25.99

Black
Midnight Navy
Slate Gray
Heather French Blue
Nickel Gray
Tan
Light Blue
White
Solid Color Shirts

Gray/Black
Tan/Brown
Light Blue/Navy
White/Navy
White/Black
Two-Tone Shirts (check descriptions for availability)

Black
Midnight Navy
Heather Gray
Brown
Spruce
Tan
Trousers (check descriptions for availability)

VISIT US ONLINE

Shop our entire professional uniform collection at galls.com/traditional-uniforms



Light Blue

Standard Black

Women's pants are specially designed for the female body to give a better fit



Navy

DutyPro™

DutyPro™ Polyester Shirts

The affordable solution for a crisp, clean appearance.

- 5 oz, 100% polyester
- Pocket flaps with VELCRO® brand closures
- Convertible collar; collar stays; sewn-in military creases
- Reinforced epaulets; extra-long internal badge sling

Colors: Men's Black, Light Blue, Gray, White, Navy.
Women's Light Blue, White, Navy. Sizes: (SH746) S-6X.
(SH1434) S-6X Regular, M-6X Long. Women's (bust) 32-48. Customization: See options starting on p. 100

Short Sleeve starting at \$27.29+

Men's **6R1-SH746**

Women's **6R1-SH883**

Long Sleeve starting at \$29.39+

Men's **6R1-SH1434**

Women's **6R1-SH884**

DutyPro™ Polyester Pants

Easy-care fabric with color retention and minimal shrinkage.

- 7.0 oz, 100% polyester twill
- Bartacked at all stress points
- French fly; YKK® zipper

Sizes: Men's 28-36 all, 38-60 even. Women's 4-24.

FREE hemming to 35", see p. 100

Standard starting at \$26.29+

Men's **6R1-TR310**

Women's **6R1-TR312**

Men's SAP **6R1-TR311**
starting at **\$30.49+**

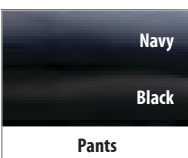
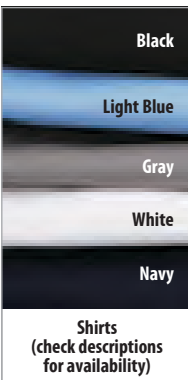
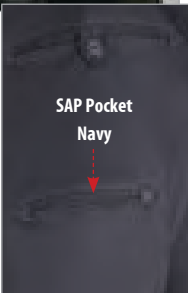

Horace Small™ Sentry Plus Polyester Uniforms

Appear professional throughout long shifts in uniform shirts with Visa® finish for moisture management. Material wicks away moisture, releases wrinkles and protects against typical stains.

Zip Front Shirts: Added side length keeps shirt tucked in neatly, no matter how you bend or stretch throughout the day.

- Zipper front with button appearance on men's shirt; women's shirt has button front
- Convertible collar on short sleeve
- Sewn-in creases
- Badge tab with reinforced sling and eyelets

Men's long sleeve sizes (neck/sleeve): 14½-16½/32; 15-18½/33, 34; 15½-18½/35, 36

Description

Item	Price
Men's Short Sleeve 6R1-ZA746	\$39.99
Men's Long Sleeve 6R1-ZF013	\$48.99
Women's Short Sleeve 6R1-ZE582	\$39.99
Women's Long Sleeve 6R1-ZA3777	\$48.99

Trousers: Cool-Flex® waistband and Visa® moisture management wicks moisture away from your body and keeps you comfortable, stain free and cool under pressure.

- Double-welt, top-stitched pockets
- Triangular bartacks on pockets
- Button tab on pocket closure

Colors: Cargo available in Dark Navy only. Men's sizes: 28-38 all, 40-54 even. Women's: 4-24, even. **FREE** hemming to 35", see p. 100

\$44.29

Men's **6R1-TR052**

Women's **6R1-TR764**

Cargo \$60.89

Men's **6R1-TR794**

Women's **6R1-TR795**

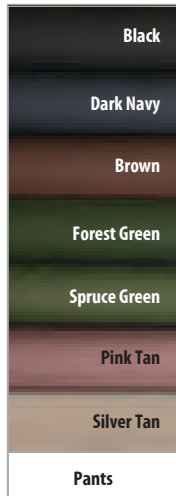
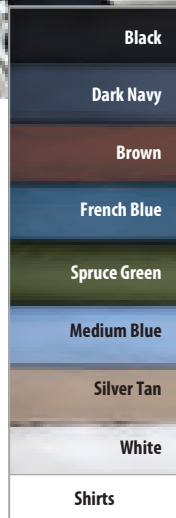

Visit us online for pricing on additional options.

Ordering online? Use your **PROMOTIONAL CODE** from the back cover

800.477.7766 • galls.com

85

Perform Your Best with Elbeco™



Learn more about Ladies Choice features on p. 73



Elbeco™ Classic TexTrop2 Uniform Shirts

The next generation of the TexTrop series with improved storage and functions.

- Polyester tropical weave
- Nano Fluid Repellent Technology
- Dual flex underarm mesh vents for ventilation
- Chest pockets with dual access top and side utility compartments with hook-and-loop closure
- Dual comm wire access openings

Sizes: SH855 (neck): 14½-18½. SH874 (neck/sleeve): 15-16/32; 15-15½/33; 15½-18/34; 16-18½/35, 36. Women's 28-44

Short Sleeve \$44.99

Men's **6R1-SH855**

Women's **6R1-SH856**

Long Sleeve \$49.99

Men's **6R1-SH874**

Women's **6R1-SH875**

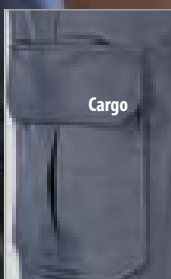

Cargo pockets provide handy access to and more storage for your gear

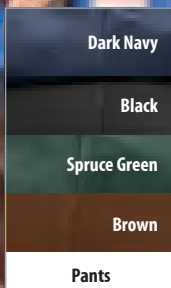

Elbeco™ Classic TexTrop2 Uniform Trousers

Features a men's Essential Fit pattern waistband with a lower rise, wider leg and front rise with a slight slope.

- Polyester stretch textured serge weave
- Nano Fluid Repellent Technology
- Covert flex waistband with refined curtain provides 2" stretch while supporting a duty belt
- Triple-stitched crotch

Colors: (TU610, TU611) all. (TU608, TU609, TT172, TT169)

Dark Navy. Sizes: Men's 28-54 even. Women's 2-24 even.

FREE hemming up to 35", see p. 100

4-Pocket \$48.99

Men's **6R1-TU610**

Women's **6R1-TU611**

Cargo-Pocket \$59.99

Men's **6R1-TU608**

Women's **6R1-TU609**

Hidden Cargo-Pocket \$62.99

Men's **6R1-TT172**

Women's **6R1-TT169**



Short Sleeve Dark Navy



Elbeco™ Undervest Shirts

Made to be worn under the V1 and V2 Vest Carriers — matches the look of the original TexTrop Uniform Shirt.

- Undervest portion constructed of featherweight Ufx performance fabric
- Visible portion is textured stretch polyester tropical weave
- Nano Fluid Repellent Technology; antimicrobial
- Tri-button, front-lined placket with mic loop
- Dual comm wire side access
- Tapered fit

Colors: (Men's) all. (Women's) Spruce Green, Dark Navy.

Sizes: S-3X, see size charts C and F on p. 98

Short Sleeve \$42.99

Men's **6R1-SH084**

Women's **6R1-SH085**

Long Sleeve \$48.99

Men's **6R1-SH086**

Women's **6R1-SH087**

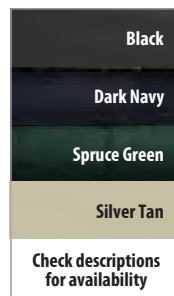

Command Respect with Flying Cross®



Flying Cross® Zipper Command® Shirts

Polyester fabric offers a professional look while keeping you comfortable.

- Convenient zipper front with a traditional button look
- Permanent sewn-in creases and collar stays
- Full badge sling

Sizes: Men's short sleeve (neck): 14½-18½. Long sleeve (neck/sleeve): 15½-16/32; 15½-17½/33; 15½-18/34; 16-18½/35; 16½-18½/36. Women's (bust): 32-46, even. Customization: See options starting on p. 100

Polyester: Breathable and moisture wicking, VISA® System 3 polyester fabric also accelerates soil release with washing.

Short Sleeve starting at \$51.99+

Men's **6R1-SH070**
Women's **6R1-SH119**

Long Sleeve starting at \$59.69+

Men's **6R1-SH071**
Women's **6R1-SH121**

Power Stretch Polyester: Designed for law enforcement officers with power stretch panels for added mobility, even throughout the shoulders. The polyester fabric is wrinkle resistant and breathable for all-day comfort.

Short Sleeve starting at \$52.49+

Men's **6R1-SH078**
Women's **6R1-SG240**

Long Sleeve starting at \$65.39+

Men's **6R1-SH083**
Women's **6R1-SG239**

Flying Cross® Pants

Enjoy a professional look and style.

- Women's available in Fashion Fit for a more precise fit
- Tab left hip pocket and quarter top pocket
- Bartacked stress points for durability; LINTRAK® creases

Sizes: Men's 28-54, even. Women's: 6-24, even. **FREE** hemming, up to 35" for men, up to 32" for women. See customization, starting on p. 100

Polyester: Made of a professional-looking and high-performance VISA® polyester fabric with gabardine weave. Freedom Flex waistband for mobility and comfort.

Standard starting at \$48.89+

Men's **6R1-TR082**
Women's **6R1-TR083**

Cargo starting at \$68.99+

Men's **6R1-TR623**
Women's **6R1-TR624**

Hidden Cargo (available in LAPD Navy only)

starting at \$71.49+

Men's **6R1-TU156**
Women's **6R1-TU165**



- LAPD Navy
 - Black
 - Light Blue
 - White
- Shirts
- LAPD Navy
 - Black
- Pants



Learn more about Women's Fashion Fit features on p. 73

+ Visit us online for pricing on additional options.



Flying Cross® Polyester Hybrid Performance Shirts

Flying Cross brings together traditional design and modern function. This Class A styled shirt is constructed from the durable fibers of polyester for unbeatable resistance to abrasions, tears, soil and shrinkage. This Hybrid Shirt is also permeated with a revolutionary fabric technology that actually decelerates perspiration by accelerating evaporation.

- 100% polyester with UVA and UVB Protection
- 37.5 Active Particle Technology decreases odor retention
- Uniform shirt design at the top; performance shirt design at bottom; athletic fit

Colors: Black, LAPD Navy, Tan, White. Sizes: Short Sleeve in XS-4X; Long Sleeve in XS-S XShort, Short, Reg; M Short, Reg, Lng; L-XL Short, Reg, Lng, XLng; 2X-4X Reg, Lng, XLng

Description	Item	Starting at
Short Sleeve	6R1-SG928	\$44.99+
Long Sleeve	6R1-SG938	\$49.99+



Wear with the Aero Shell Advanced Armor Cover

Check out the matching Flying Cross® Aero Shell on p. 350.

Shirts starting at
\$19.99

Light Blue

Navy



LawPro® Polyester Cotton Uniform Shirts

The performance of stain- and wrinkle-resistant polyester with the breathable comfort of cotton.

- Premium fabric treated for maximum soil, stain and wrinkle resistance
- Pen slot on left pocket
- 5 sewn-in military creases and permanent collar stays
- Button down epaulets include mic attachment
- Sling badge tab holds any pin-back badge with no sagging

Men's Sizes: XS-6X, see size chart K on p. 98

Description	Item	Starting at
Short Sleeve	6R1-SR997	\$19.99+
Long Sleeve	6R1-SR996	\$21.49+

LawPro® Polyester Cotton Four-Pocket Trousers

We've created the ultimate affordable uniform trousers without compromising quality.

- Constructed of rugged polyester and combed cotton twill
- Permanent press finish resists wrinkles but is cool and breathable for added comfort
- Front pocket and set-in hip pockets
- Security button closure at waist
- Safety-stitched main seams, double-needle stitching and durable brass zipper for heavy use

Men's Sizes: 28-60

6R1-TR965 starting at \$25.19+

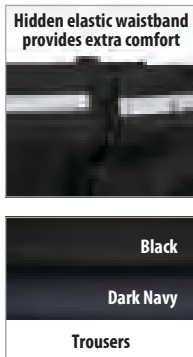
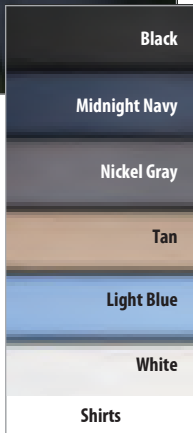

Hidden elastic waistband provides extra comfort

Trousers



Traditional Style
White

Navy

DutyPro™

DutyPro™ Polyester Cotton Shirts

DutyPro™ Polyester Cotton Shirts offer a lot more than a great price compared to what you'll find elsewhere. These shirts give you features and details, as well as customization choices, that the competitors just can't match for the price.

- 5 oz, 65% polyester, 35% cotton
- Traditional Style: creaseless with pleated pockets and mitered pocket flaps
- Military Style: ewn-in creases with pleated pockets and scalloped flaps
- Short Sleeve: convertible collar
- Long Sleeve: banded collar
- Button down epaulets
- Badge tabs with internal slings for added support

Sizes: (SH610, SH612) S-5X. (SH1438, SH1440) S-2X Reg, S-6X

Lng, see size chart F on p. 98. (SR572, SR573) 28-52 even.

Military Style Shirt is available in Women's sizes (white only).

Customization: See options starting on p. 100

Men's Traditional Style

Short Sleeve **6R1-SH610 starting at \$24.19+**

Long Sleeve **6R1-SH1438 starting at \$26.29+**

Short Sleeve Military Style

Men's **6R1-SH612 starting at \$24.99+**

Women's **6R1-SR572**

Long Sleeve Military Style

Men's **6R1-SH1440 starting at \$26.99+**

Women's **6R1-SR573**

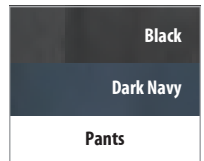
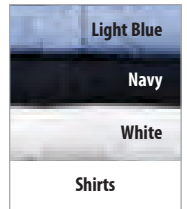

DutyPro™ Polyester Cotton Trousers

DutyPro Pants give you features that you might expect from more expensive styles. They start with a roomier seat and crotch, plus have a hidden elastic waistband that automatically adjusts for a comfortable fit.

- Snugtex® waistband liner keeps shirts tucked
- Crush-proof hook-and-eye closures
- Bartacked stress points and French fly

Men's sizes: 28-60. Women's sizes: 4-26. **FREE** hemming available, up to 36" for men, 35" for women, see p. 100

Starting at \$31.49+

Men's **6R1-TR355**

Women's **6R1-TR356**



Visit us online for pricing on additional options.





Learn more about Fashion Fit features on p. 99



Flying Cross® Deluxe Tropical Weave Shirts

Comfortable from the beginning, these shirts become even more so with each machine washing.

- Dacron® polyester and rayon fabric blend
- Form-fitted tapered sleeves for a tailored look
- Pleated pockets with scalloped flaps and VELCRO® brand closure; left full badge sling
- Permanent silicone creases front and back
- Cross-stitched shoulder straps for a neat appearance
- Short-sleeve has sport collar; long-sleeve has banded lined collar and yoke

Sizes: SH098: S-6X. SH099: (neck): 14½-18½. Sleeve length (neck/sleeve): 15-16"/32", 15½-17½"/33", 15½-18"/34", 16-18½"/35", 16½-18½"/36". SR562, SR563: (chest): 30-50, even only. (sleeve): 30 Regular, 32-52, Regular or Long. Customization: See options starting on p. 100

Short Sleeve \$57.19+

Men's **6R1-SH098**
Women's **6R1-SR562**

Long Sleeve \$62.49+

Men's **6R1-SH099**
Women's **6R1-SR563**



Flying Cross® Deluxe Serge Weave Pants

Pants are made with Lycra®, so they stretch yet retain their shape, eliminating premature bagging.

- 70% polyester, 28% rayon, 2% Lycra®
- Color and fade resistance
- 2 front and 2 rear pockets; cargo style also has 2 cargo pockets with cell phone holder in right pocket
- LINTRAK® creases, front and back; French fly
- Expandable Freedom Fit® waist with Tru-Grip
- Women's has Fashion Fit for a more precise fit

Men's sizes: 28-54. Women's sizes: 6-24. **FREE** hemming to 35", see p. 100

Standard starting at \$74.89+

Men's **6R1-TR001**
Women's **6R1-TR621**

Cargo starting at \$93.89+

Men's **6R1-TR197**
Women's **6R1-TR622**

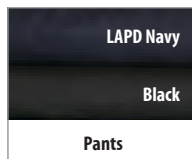

Cargo Pocket with Cell Phone Holder

Elbeco™ Duty Maxx Shirts

Permanent stretch in the material increases range of movement for maximum comfort, while fluids bead up and roll off with Nano Fluid Repellent Technology for a dry and professional look.

- Polyester-rayon fabric
- Nano Fluid Repellent Technology
- UV 40+ sun protection to keep garment from fading
- Double-pleat sleeve construction for added mobility
- Permanent military creases
- Badge eyelets with internal support strap
- Extra-long tails to keep shirt tucked in neatly
- Short sleeve comes with a convertible collar

Sizes: Men's short sleeve (neck): 14½-22. Long sleeve (neck/sleeve): 14½-18"/32, 33, 34", 15-18"/35", 15½-18"/36-37", 18½-20"/33, 34, 35, 36, 37".

Customization: See options starting on p. 100

Short Sleeve \$62.99

Men's **6R1-SR600**
Ladies Choice **6R1-SR747**

Long Sleeve \$69.99

Men's **6R1-SR598**
Ladies Choice **6R1-SR746**

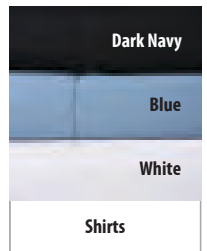

Elbeco™ Duty Maxx Trousers

Duty Fit™ waistband allows garment to take advantage of the stretch in the material without adding bulk to the waistband.

- Polyester-rayon with fabric stretch
- Fluids bead up and roll off with Nano Fluid Repellent Technology for a dry and professional look
- UV 40+ sun protection to keep garment from fading
- Creaset® permanent creases; triple-stitched crotch

Colors: Cargo comes in Dark Navy only. Sizes: Men's 28-36 all sizes, 38-54 even. Women's: 6-24, even. **FREE** hemming to 35", see p. 100

Four Pocket \$69.29

Men's **6R1-TR674**
Women's **6R1-TR675**

Cargo \$90.49

Men's **6R1-TR850**
Women's **6R1-TR851**

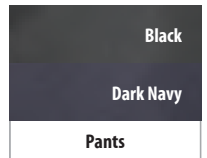

Hidden cargo pockets provide hidden storage and easy access to gear

Spiewak's® Grip System Keeps Shirts Tucked In



Polyester
White

**NEW
FABRIC**



Spiewak® SPDU™ Performance Duty Shirts

Designed to withstand the daily demands of your job.

- Silicon grip Shirt Retention System®
- Removable microphone sling
- Reinforced inside badge sling

Polyester: 100% polyester. Nano technology for water and stain resistance. Colorfast, breathable, comfortable, durable and wrinkle-free fabric. UV protection of 40+ UPF.

Colors: (SR648) Black, Dark Navy, Green, White. (SR660, SR649) Black, Dark Navy, White. (SR650) Dark Navy, White. Sizes: (SR648) S-5X. (SR660, SR650) 30-48 even. (SR649) 14½-20" 32/33; 14½-22" 34/35; 15-22" 36/37

Short Sleeve starting at \$62.99+

Men's **6R1-SR648**

Women's **6R1-SR660**

Long Sleeve starting at \$64.99+

Men's **6R1-SR649**

Women's **6R1-SR650**

NEW Polyester Wool: Polyester-wool blend with stretch. Hidden double pen pocket and chest pocket. Collar stays, zippered front closure and permanent military creases.

Colors: (SH891, SH905) Black, Dark Navy. (SH892, SH916) Dark Navy. Sizes: (SH891) 14½-22½. (SH892, SH916) 30-48 even. (SH905) 14½-22.

Short Sleeve starting at \$81.19+

Men's **6R1-SH891**

Women's **6R1-SH892**

Long Sleeve starting at \$89.39+

Men's **6R1-SH905**

Women's **6R1-SH916**

Spiewak® SPDU™ Performance Cargo Trousers

Combining innovation in design and the latest in apparel technology, these trousers are a cut above the rest.

- Slash side pocket with hidden pocket security zipper
- Welt zippered Hidden & Secure® cargo pockets (except for TU616)
- Hidden Expand-on-Demand adjustable waistband
- Silicon grip Shirt Retention System®

Polyester: 100% polyester. Nano technology for water and stain resistance. Colorfast, breathable, comfortable, durable and wrinkle-free fabric. UV protection of 40+ UPF.

Colors: Men's Black, Dark Navy. Women's Dark Navy. Sizes: Men's 28-54 even (31-37 odd inseams). Women's: 4- 24, even. **FREE** hemming available, up to 36" for men, 35" for women, see p. 100

Starting at \$81.19+

Men's **6R1-TR713**

Women's **6R1-TR714**

NEW Polyester Wool: Polyester-wool blend. Welt back pockets and heavy-duty tuxedo pocketing.

Dark Navy. Sizes: 28-56 even (31-37 odd inseams). **FREE** hemming available, up to 36" for men, see p. 100

Starting at \$101.49+

Men's Internal Cargo **6R1-TU614**

Men's Four-Pocket **6R1-TU616**

Black

Dark Navy

White

Check description for availability

+ Visit us online for pricing on additional options.

Polyester-Wool Keeps You Warm and Comfortable



Flying Cross® Tropical Weave Deluxe Wool Shirts

Improved fiber-dyed, natural stretch fabric, which produces deep, rich colors and shade continuity.

- Polyester-wool with natural stretch
- 2 pleated pockets with scalloped flaps and VELCRO® brand closures
- Concealed zipper with button front look
- Permanent silicone creases

Made in the USA/Imported. Colors: (SR619, SR620) all. (SR621) LAPD Navy. (SR622) Black, LAPD Navy, Silver Tan. Sizes: Men's (neck): 15-18½. Sleeve length (neck/sleeve): 15-16"/32", 15½-17½"/33", 15½-18"/34", 16-18½"/35", 16½-18½"/36". Women's (chest): 30-50, even only. Sleeve length: 30 Reg, 32-52 Reg or Lng

Short Sleeve starting at \$73.99+

Men's **6R1-SR619**

Women's **6R1-SR621**

Long Sleeve starting at \$82.19+

Men's **6R1-SR620**

Women's **6R1-SR622**

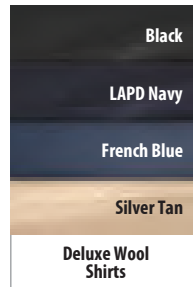

Flying Cross® Power Stretch Duty Shirts

Power stretch panels for added mobility, even throughout the shoulders.

- Polyester-wool
- Wrinkle resistant with military creases
- Innovative hidden chest-front map pockets
- Breathable knit side panels for cool comfort and mobility; zipper front

Sizes: Men's (neck) 14½-22/31, 33, 35, 37. Men's Short Sleeve in S-4X Regular.

Women's 30-50 Reg and Lng

Short Sleeve starting at \$76.29+

Men's **6R1-SH919**

Women **6R1-SR321**

Long Sleeve starting at \$81.79+

Men's **6R1-SH848**

Women's **6R1-SR323**

Flying Cross® Serge Weave Wool Blend Pants

The substantial weight and deluxe features of these pants provide a professional look.

- Polyester-wool with natural stretch
- Freedom Flex stretch waistband for comfort
- Tru-Grip waistband to keep shirt tucked in
- Permanent creases for sharp appearance

Made in the USA/Imported. Sizes: Men's 28-38, even and odd; 40-54, even only.

FREE hemming up to 35", see p. 100

Starting at \$88.39+

Men's **6R1-TR677**

Women's **6R1-TR678**

Vertex Cargo: The low-profile Vertex cargo pocket provides extra storage but maintains a traditional Class A look.

6R1-TR862 starting at \$119.19+

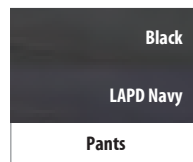
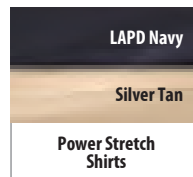

Elbeco™ Distinction Appareil

Distinctive design and modern function unite in Class A uniform styled apparel from Elbeco. The Distinction line is made from a combination of polyester and wool for a fabric fusion that will not disappoint.

- Shirts: 5.5 oz/sq yd, 75% polyester, 25% wool
- Pants: 7.6 oz/sq yd, 74% polyester, 25% wool, 1% Lycra® premium serge weave

Shirt: Hidden zipper for easy, tapered closure. Chest pockets, compartments with hook-and-loop closure, and side pockets. Underarm vents and wire access openings. Navy. Sizes: Men's 32-48, Women's 14.5-22

Short Sleeve starting at \$68.99

Men's **6R1-SG909**

Women's **6R1-SG917**

Long Sleeve starting at \$74.99

Men's **6R1-SG908**

Women's **6R1-SG916**

Four-Pocket Trousers: Concealed zipper compartment in left front pocket and covert flex waistband. Triple-stitched crotch and permanent creases.

Navy. Sizes: Men's 28-54. Women's 2-24

94.99

Men's **6R1-TR036**

Women's **6R1-TR060**

Ordering online? Use your **PROMOTIONAL CODE** from the back cover

800.477.7766 • galls.com

91

Traditional Uniform Separates



Navy Blue



Edwards® Uniform Blazers

Traditional two-button single breasted cut is always in style.

- Textured woven polyester for wrinkle resistance and comfort
- Soft shoulders and back center air vent
- Dry clean only

Sizes: Men's 36-46 Short, 36-64 Reg, 38-64 Lng, 42-52 XLng. Women's 4-28 Reg even, 14-22 Lng even

Starting at **\$67.99+**

Men's **6R1-JA317**
Women's **6R1-JA809**

Black
Navy Blue



Single Breasted



Double Breasted



Flying Cross® Polyester Dress Coats

Enjoy the stylish look of these fully lined coats.

- 11-11.5 oz, 100% VISA® System 3™ polyester, serge weave; lined inside sweat shields on Single
- 2 lower simulated pockets with plain flaps
- 2 inside cloth reinforced breast pockets on Single; 1 inside breast pocket on Double
- Shoulder pads and coat front tailoring
- Four-button front and notched lapels on Single; six-button front and peak lapels on Double
- Gold FD buttons unless otherwise specified
- Badge tab (comes unattached)
- Dry clean only

Navy. Sizes: Men's Single in 34-58; Men's Double in 32-60, 62

Description	Item	Starting at
Single Breasted	6R1-JA770	\$178.19+
Double Breasted	6R1-JA771	\$196.89+



Charcoal



Edwards® Wool Blend Suit Coat

Classic tailored suit coat with a button front closure.

- Polyester-wool fabric blend
- Welt breast pocket
- 2 in-set pockets
- Interior pockets
- Center back vent for men
- Dry clean only

Sizes: 36-58 even in Short, Reg, Lng

6R1-JA981 starting at \$182.69+

Black
Charcoal
Navy

VISIT US ONLINE

Look sharp with a variety of public safety uniforms for every season and task: galls.com

+ Visit us online for pricing on additional options.



Charcoal



Navy



Edwards® Wool Blend Pants and Skirt

Edwards separates take corporate, resort and hospitality security to an elevated level of style, sophistication and comfort. Polyester and wool blend fabric provides the comfort and look of wool with the durability of polyester to keep you looking your best all day.

Pleated Dress Pants

- Sharply tailored with pleats, tapered seat seams with lined crotch and extended fly lining
- 2 front and back pockets
- Hook-and-eye closure with brass zipper for a secure and durable closure

Men's Sizes: 28-54 even

6R1-TU135 starting at \$57.89+

Women's Skirt

- Straight skirt with no pockets
- Rear kick pleat and fully lined
- Button and nylon zipper closure

Women's Sizes: 0-18 (25" length), 18W-28W (26" length)

6R1-TR986 starting at \$67.99+

Black
Charcoal
Navy

for a Sharp, Professional Appearance



Edwards® Navigator Shirts

A crisp, professional shirt with moisture and wrinkle resistance.

- Polyester-cotton fabric
- Creaseless front with pointed pocket flaps
- Mock cuff on short sleeve

Sizes: Men's S-3X Reg, L-6X Lng. Women's XXS-3X

Short Sleeve starting at \$25.39+

Men's **6R1-SH089**
Women's **6R1-SH097**

Long Sleeve starting at \$27.39+

Men's **6R1-SH091**
Women's **6R1-SH101**

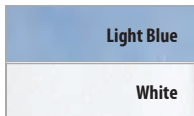

White

Short Sleeve
French Blue



Edwards® Classic Dress Shirt

Soft and comfortable cotton-polyester blend broadcloth.

- Cotton-polyester blend
- Stain and wrinkle-resistant finish
- Left chest pocket
- Two-button adjustable cuff

Sizes: Men's S-5X. Women's 4-28 even

Short Sleeve starting at \$20.29+

Men's **6R1-SH1459**
Women's **6R1-SH1457**

Men's Long Sleeve starting at \$20.29+
6R1-SH1458

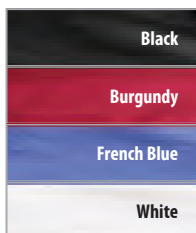

Light Blue



Edwards® Signature Non-Iron Dress Shirt

Stay professional while on the go with a tailored fit.

- Polyester-cotton blend
- Wrinkle free
- Button front
- French placket
- Taped seams
- Single-needle tailoring

Sizes: Men's S-6X Reg, L-XL Tall. Women's S-3X

Starting at \$36.59+

Men's **6R1-SH709**
Women's **6R1-SH708**

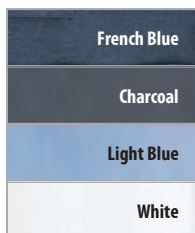

Long Sleeve

Short Sleeve



Flying Cross® Polyester Blend Shirts

Experience the comfort of polyester-blend shirts!

- 4.25 oz, 65% dacron polyester, 35% cotton duro poplin
- StainSmart treatment repels liquids and releases stains
- Pleated pockets and mitered pocket flaps
- Seven-button placket front (on most models)
- Conventional collar and band with permanent collar stays
- Shoulder straps cross stitched symmetrically for neater appearance

White. Sizes: Men's SS 14½-18½, 19-22 Reg and Lng. Men's LS 14½-18½, 19-24 Reg. Women's SS 4-30. Women's LS 6-30

Short Sleeve starting at \$39.99+

Men's **6R1-SR564**
Women's **6R1-SR566**

Long Sleeve starting at \$49.99+

Men's **6R1-SR565**
Women's **6R1-SR567**

Black



LawPro® Commando Sweater

A cold-weather essential, LawPro's take on the classic commando sweater is made from deluxe acrylic yarn for superior comfort, shape retention and durability. Gives a clean and professional appearance when layered over your uniform shirt.

- Deluxe acrylic yarn weave
- Anti-pilling and shrink resistant
- Retains color wash after wash
- Twill shoulder and elbow fabric patches
- Badge tab

Sizes: Men's S-5X, see chart E on p. 98

6R1-SW020 \$31.99

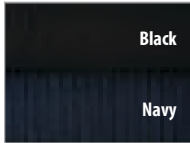

¼ Zip
Dark
Navy



Flying Cross® Fleece Lined Commando Sweaters

Makes a casual yet stylish statement. Perfect for on or off duty.

- Fleece lined
- Wind resistant
- Badge tab and name plate included, unattached

Sizes: Men's XS-4X, see size chart F on p. 98

Starting at **\$108.99+**

¼ Zip **6R1-ST324**
V-Neck **6R1-ST315**

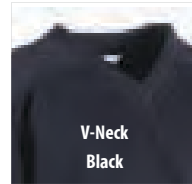
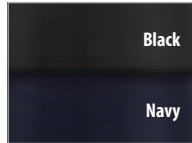

V-Neck
Black



Visit us online for pricing on additional options.

Black



PSC Uniform Apparel by COBMEX V-Neck Jersey Knit Commando Sweaters

Block out the elements with these stylish sweaters.

Sizes: Men's XS-6X, see size chart B on p. 98

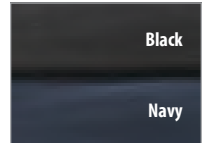

With Windstopper® Liner:

- DuraPil acrylic, wool blend
- Windproof, water-resistant, breathable lining
- VELCRO® brand epaulets, polyester-cotton patches on shoulders and elbows

6R1-ST280 starting at \$157.39+

With Polar Fleece Liner:

- Polyester, wool and acrylic shell
- Polyester micro-fleece lining

6R1-ST281 starting at \$95.39+



Mock Turtleneck
Black



Mock Dickie
Navy



Turtleneck
Black



Turtleneck Dickie
Black

Galls® Cotton Long Sleeve Turtleneck, Mock Turtleneck and Dickies

Turtlenecks are about as versatile as it gets. They can be worn alone or layered. Dickies give a more "finished" look without adding bulk.

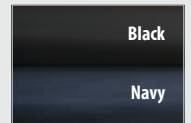

Long Sleeve Turtleneck and Mock

These Turtlenecks and Mocks offer a professional look that never goes out of style. Combed cotton with reinforced Lycra® neck and cuffs. Generous fit and extra-long tails for wearing over body armor.

Sizes: S-3X, see size chart A on p. 98

Starting at **\$22.99+**

Mock Turtleneck **6R1-SG514**
Turtleneck **6R1-SG512**

Dickies: Professional look but much cooler. Our Dickies are made of preshrunk cotton. One size fits all. Available in mock or turtleneck.

\$9.89

Mock Turtleneck **6R1-SG513**
Turtleneck **6R1-SG511**

Headquarters for Uniform Accessories

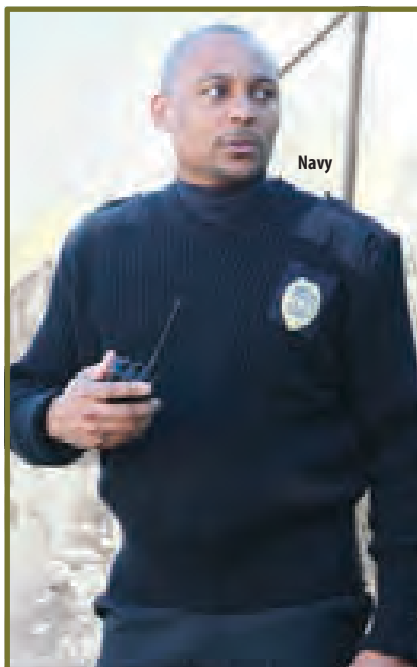

Galls® Commando V-Neck Sweaters

Choose acrylic or an acrylic-wool blend for more warmth.

- Color-matched fabric shoulder and elbow patches
- Turn-back cuffs
- Badge tab and shoulder epaulets

Sizes: Men's S-5X, see size chart B on p. 98

Description	Item	Starting at
Acrylic	6R1-SW667	\$34.99+
Acrylic/Wool	6R1-SW665	\$41.99+

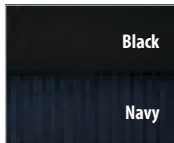

LawPro®

LawPro® Stirrup-Style Shirt Stays

Quick and easy on-the-spot adjustments.

- No need for sock attachments
- Set includes 2 straps

One size fits all

6R1-SH227 \$11.79



Shirt Stay Plus Original

Maintain a neat, professional appearance with this adjustable, hidden shirt stay.

- Custom adjuster allows for a perfect fit
- Elastic strap

One size fits all

6R1-SR452 \$19.99



Shirt Stay Plus Stirrups

Comfortable, long-lasting wear.

- Metal clip
- Plastic buckle
- Elastic strap

One size fits all

6R1-UX367 \$21.99



Also available in black

Shirt Garter

Flexible Waist Belt

Galls® Flexible Waist Belt and Shirt Garter Kit

Wear rubber waist belt under slacks and over shirt to keep your shirt tucked in neatly. Then attach one end of garter to socks and other to back of shirt.

Sizes: Waistbelt fits waists up to 50". Garter is one size fits most.

6R1-UA725 \$19.99 **SAVE 24%**
 \$26.48 if purchased separately
 Flexible Waist Belt only 6R1-UA331 \$14.69
 Shirt Garter only 6R1-UA760 \$11.79/4 pk



Hero's Pride® Collar Extender Pack

Clips to existing button of your shirt. Self-adjusting. Two per pack

6R1-UA759 \$6.99

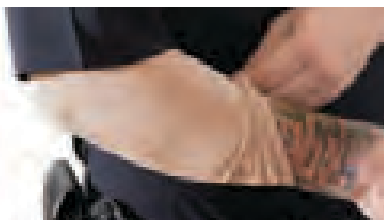

TatJacket™ Temporary Tattoo Cover-Up

The easy-to-wear TatJacket™ allows you to wear your uniform during hot seasons and not violate department policy on tattoos.

- 90% nylon, 10% spandex
- UPF 50 UV sun protection
- Non-slip gripper top cuff keeps sleeves in place
- 2 sleeves per pack

17" long; 3.5" at the wrist cuff; Medium is 5.5" at top cuff; Large is 6.5" at top cuff

6R1-UA952 \$21.79



Hatch® White Dress Gloves

Cotton white gloves are machine washable and won't shrink.

- 3 sewn-in creases
- Snap closure

Sizes: S-XL, see size chart P on p. 99

6R1-GL098 \$6.29/pr



Sergeant
Black/Gold

Lieutenant
Black/Silver

Epaulets

These soft shoulder epaulets are double stitched to ensure long life, and bartacked to prevent seam ripping during prolonged use.

4¼"H x 1⅞"W x 2¼"D

Starting at \$19.29+

Police Ranks 6R1-UA004
 Fire Ranks 6R1-UA005

Ties, Caps and Hats

Starting at
\$4.29



Galls® Solid Color Ties

Polyester ties slip off or unsnap easily when pulled, so they can't be used to a criminal's advantage.

Made in the USA

Crossover: Adjustable band with button snap
6R1-UA033 starting at \$4.29+

Clip-On: 3" wide with permanent knots and button holes to keep the tie straight. Simply slide the small end of tie through the loop and button to the shirt.

Lengths: Short, Regular, Long, Extra-Long

6R1-UA494 starting at \$6.19+

Breakaway: 3" wide with permanent knots, VELCRO® brand fasteners and button holes to keep the tie straight. Simply slide the small end of tie through the loop and button to the shirt.

Lengths: Short, Regular, Long, Extra-Long

6R1-UA495 starting at \$5.99+

Collar Extender Pack **6R1-UA759 \$6.99/2 pk**



Black
Navy
Green
Brown
Taupe

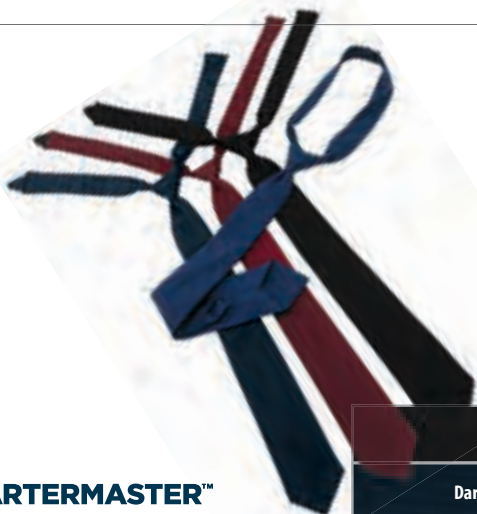

Quartermaster™ Breakaway Ties

Adjustable VELCRO® brand neckband breaks away for safety and convenience. Pre-tied. Polyester-tropical weave.

6R1-UA010 \$7.09

Black
Dark Navy
Maroon
Medium Navy

The Tie Thing

Slide The Tie Thing under the loop on the back of your tie. Then, button to two buttons on your shirt to control the tie and keep you looking neat.

- Button holes big enough to allow for slight differences in button spacing and allows for movement
- Will not puncture or snag neck tie
- Remains hidden behind the tie
- Flexible and soft so you won't feel it on your shirt
- Sets: 1 Black with 1 White fastener; or 1 Dark Navy with 1 Light Blue fastener



Black/White
Dark Navy/Light Blue

6R1-UN140 \$5.99/2 pk

Campaign Uniform Hat

Traditional four-dent style with an extra-stiff 3" wide brim.

Made in the USA. Sizes: 6½"-7¾", see size chart U on p. 99

6R1-HW795 \$94.99

Ground shipping recommended for Campaign Hats; additional charges will apply for air shipments.

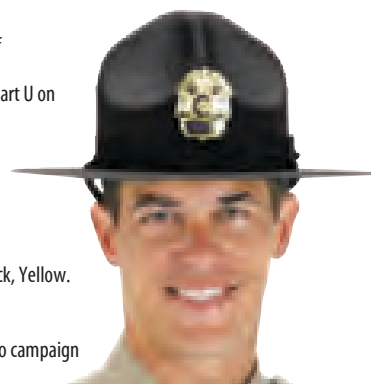

Campaign Hat Accessories

Hat Cord: Black/Gold, Gold, Silver, Slate Black, Yellow.

6R1-HW791 \$7.69

Swivel Chin Strap: Leather strap attaches to campaign hat to wrap around the chin.

6R1-HW260 \$7.89

Clear Plastic Rain Cover: Protect your campaign hat from the elements.

6R1-HW263 \$7.99

Black
Navy



Navy

Straw Triple Brim Campaign Hat

High-quality classic hat with a triple brim, so it keeps its shape longer. Comes with **FREE** adjustable leather strap.

Made in the USA. Sizes: 6½"-7¾", see size chart U on p. 99

6R1-HW257 \$106.59

Black
Navy
Brown



Navy

Felt Campaign Hat with Adjustable Leather Chinstrap

Superior quality for lasting shape retention

- Felt fabric
- Includes **FREE** adjustable leather chinstrap

Made in the USA. Sizes: 6½"-7¾", see size chart U on p. 99

6R1-HW258 starting at \$109.99+

Black
Navy
Green
Brown
Taupe



Black

Trooper Style Uniform Hat

Extra-stiff double-dense brim with side curl.

- Open weave ventilated crown
- Includes adjustable leather chin strap

Made in the USA. Sizes: 6½"-7¾", see size chart U on p. 99

6R1-HW790 \$108.59

Black
Navy

to Outfit any Occasion



HAT-PAK™ Brim Press

Keeps the brim of your campaign hat in its original shape.

- Reduces brim curling caused by heat, humidity and moisture
- Lightweight for convenient carry

6R1-HW810 \$44.39



Campaign Hat Carrier

Unique hat carrier presses the brim when closed, keeping your brim straight and flat.

6R1-HW815 \$54.99



Midway Cap Co. Trooper Caps

Faux fur trimmed ear flaps and quilted lining.

Made in the USA. Sizes: S-2X, see size chart U on p. 99

Description	Item	Price
Vinyl Crown	6R1-HW514	\$23.39
Taslon Crown	6R1-HW515	\$30.49

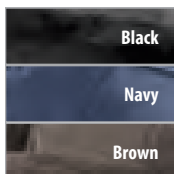

LawPro® Cushion Air Service Uniform Caps

- Choose traditional 8-Point or Round Top
- Textured polyester construction
- Interior leather sweat band

Made in the USA. Colors: (8-Point and Round Top) available in Black and Navy, (Expandable Metal Strap) available in Gold and Silver. Sizes: S-2X, see size chart U on p. 99

Description	Item	Price
8-Point	6R1-HW774	\$34.99
Round	6R1-HW862	\$44.29
Expandable Metal Cap Strap	6R1-HW143	\$10.99
Frosted Fitted Rain Cover	6R1-RW235	\$5.39



8-Point
Navy



Round
Black



Midway Cap Co. Professional Duty Caps

- Polyester and gabardine
- ½" wide black plastic front strap
- Black patent leather visor
- Front eyelet to add your hat badge

Made in the USA. Sizes: S-2X, see size chart U on p. 99

CoolMax®: Does not include a headliner, which allows heat to flow out of the top of the cap and the CoolMax® liner to wick away moisture. One-piece construction keeps cap body and shape; has the fit and lightweight feel of a baseball cap. Navy

\$60.89

8-Point	6R1-HW510
Round	6R1-HW511

Polyester: Sturdy plastic inner frame and an ID sleeve in the top lining to keep track of cap.
Colors: Black, Navy.

Description	Item	Price
8-Point	6R1-HW508	\$50.79
Round	6R1-HW509	\$55.89

Expansion Straps for Duty Caps (specify Gold or Silver) **6R1-HW512 \$9.99**



Round
Navy



8-Point
Black

Midway Convertible Bell Crown Cap

Add the distinguishing touch to your uniform with this cap, set apart with silver buttons and classic navy.

- 100% polyester gabardine
- Navy band with removable black rayon braid
- Silver Fire Department buttons
- 611 pattern visor
- 1/2" black plastic strap

Made in the USA. Sizes: 6½"-7½", see size chart U on p. 99

6R1-HD355 starting at \$63.29



VISIT US ONLINE

We've got a huge selection of uniform headwear from the brands you trust most:
galls.com/headwear

Sizing Information Center

Ways to Shop

Online

Order directly from the web, 24/7. Our website is also a great way to learn more about us, request a catalog, send us an email or see more products. Visit galls.com

Phone

Let one of our knowledgeable and professional customer service representatives help you. Call 800.477.7766. Phone hours are Monday - Friday, 8:00 a.m. - 9:00 p.m. ET.

In Person

In Kentucky, visit our store in Lexington. In California, stop by one of our retail locations. Each one is open Monday through Saturday. For our retail and service center locations, visit galls.com

FAX

An order form is available to download and print at galls.com

Mail

We also accept mail orders. Contact us by phone to obtain the total for the items you want to purchase. Then mail your order, along with your check or money order, to:
1340 Russell Cave Road
P.O. Box 54430
Lexington, KY 40555

Special Orders

We can help procure items that are not available in this catalog. Some restrictions apply. Call 800.477.7766 for details.

Price Match Guarantee

Galls will match the price of the item found on the Internet for a lesser price. Item must be currently for sale by Galls. Some restrictions apply. Visit galls.com/Pages/PRICEMATCH for details.

Shipping Information

Expedient shipping is available on in-stock, non-customized merchandise. Low shipping rates are available for all orders. Some restrictions apply. For more details, contact us at 800.477.7766, or visit galls.com/Pages/SHIPPINGINFO

No Hassle Guarantee

If you are not completely satisfied with a newly purchased item, then we will repair, replace or refund the order. Some restrictions apply. For details, visit galls.com/Pages/RETURNS

Your Solutions Provider

We have the resources and expertise to be your primary supplier for uniforms and equipment that you need to safely do your job.

As the industry leader for public safety uniforms and equipment, we offer what you would expect from almost 50 years of experience.

A	MEN'S	S	M	L	XL	2X	3X	4X	5X	6X
	Chest	34-36	38-40	42-44	46-48	50-52	54-56	58-60	62-64	66-68
	Waist	28-30	32-34	36-38	40-42	44-46	48-50	52-54	56-58	60-62

B	MEN'S	S	M	L	XL	2X	3X	4X	5X	6X	7X
	Chest	36-38	40-42	44-46	48-50	52-54	56-58	60-62	64-66	68-70	72-74

Regular (to 6') and Long (6'+). See item description for availability of Regular and Long.

C	WOMEN'S	S	M	L	XL	2X	3X	4X
	Bust Size	34½-35½	36½-37½	38½-41½	41½-43	43½-45	45½-47	47½-49

D	MEN'S	S	M	L	XL	2X	3X	4X	5X	6X
	Chest	36-38	40-42	44-46	48-50	52-54	56-58	60-62	64-66	68-70
	Waist	28-30	32-34	36-38	40-42	44-46	48-50	52-54	56-58	60-62

E	MEN'S	S	M	L	XL	2X	3X	4X	5X
	Chest	34-36	37-39	40-42	43-45	46-48	49-51	52-54	55-57

F	MEN'S	XS	S	M	L	XL	2X	3X	4X	5X	6X
	Neck	13-13½	14-14½	15-15½	16-16½	17-17½	18-18½	19-19½	20-20½	21-21½	22-22½

Duty Pro®: Long sleeve available in Regular (33), Long (35) and Extra-Long (37).

Elbeco® Class Bs: Long sleeve available in Regular (32-33), Long (34-35) and Extra-Long (36-37).

Flying Cross® Shirts: Long sleeve available in Regular (34) and Long (36).

G	MEN'S	S	M	L	XL	2X	3X	4X	5X
	Chest	33-37	38-41	42-45	46-49	50-53	54-57	58-61	62-65
	Waist	27-31	32-35	36-39	40-43	44-47	48-51	52-55	56-59

Regular (to 6') and Long (6'+). See item description for availability of Regular and Long.

H	UNISEX	XS	S	M	L	XL	2X	3X	4X	5X
	Chest	32-34	36-38	40-42	44-46	48-50	52-54	56-58	60-62	64-66
	Waist	24½-27	27½-31	31½-35	35½-39	39½-43	43½-47	47½-51	51½-55	55½-59

Regular (32" Inseam) and Long (34" Inseam).

I	WOMEN'S	S	M	L	XL
	Bust Size	34½-35½	36½-38	39½-41	43-45
	Size	6-8	10-12	14-16	18-20

J	MEN'S	Short	Regular	Long	Extra Long
	Chest	34-36	34-40	38-54	40-50
	Height	up to 5'8"	up to 6'	up to 6'3"	up to 6'6"

K	MEN'S	XXS	XS	S	M	L	XL	2X	3X	4X	5X	6X
	Neck	12½	13½	14½	15½	16½	17½	18½	19½	20½	21½	22½
	Sleeve Lengths											
	Reg	30½	31½	33½	34	34½	34½	35¼	35¼	35¼	35¼	35¼
	Lng	31½	32½	34½	35	35½	35½	36¼	36¼	36¼	36¼	36¼
	XLng	32½	33½	35½	36	36½	36½	37¼	37¼	37¼	37¼	37¼

L	WOMEN'S	4	6	8	10	12	14	16	18	20	22	24	26	28	30
	Waist	22	23	25	26	29	31	32	34	35	37	39	41	43	45

for Apparel and Accessories

M	MEN'S	S	M	L	XL	2X	3X
	Chest	36	38-40	42-44	46-48	50-52	54-56
	Waist	29	30-32	34-36	38-40	42-44	46-48

N	WOMEN'S	XS	S	M	L	XL
	Bust Size	32-33	33½-35½	36-38	38½-40½	54-56
	Waist	23½-25	25½-27½	28-30	30½-32½	33-35
	Size	0-2	4-6	8-10	12-14	16

O	UNISEX	XS	S	M	L	XL	2X
	Inches	7	8	9	10	11	12

P	UNISEX	S	M	L	XL	2X
	Inches	7	8	9	10	11

Q	UNISEX	S/M	M/L	L/XL	XL/2XL
	Inches	20⅞-21½	22-23	23-24¼	24¼-25½
	Hat Size	6⅞-6⅞	7-7⅞	7⅞-7¾	7¾-8⅞

R	MEN'S	XS	S	M	L	XL	2X
	Chest	35-37	38-39	40-41	42-40	45-47	48-51

S	UNISEX	S/M	L/XL
	Hat Size	6¾-7¼	7⅞-7⅞

T	UNISEX	S	M	L	XL
	Inches	21⅞-21½	21⅞-22¼	22⅞-23	23½-23⅞
	Hat Size	6¾-6⅞	7-7⅞	7¼-7¾	7½-7⅞

U	MEN'S	S			M			L			XL		2X	
	Inches	20¼	20¾	21⅞	21½	21⅞	22¼	22⅞	23	23½	23⅞	24¼	24¾	
	Hat Size	6½	6⅞	6¾	6⅞	7	7⅞	7¼	7¾	7½	7⅞	7¾	7⅞	

V	MEN'S	XS	S	M	L	XL	2X	3X	4X
	Chest	32-34	35-37	38-40	41-43	44-46	47-49	50-53	54-57

W	MEN'S	XXS	XS	S	M	L	XL	2X	3X	4X
	Chest	33-34	35-36	37-39	40-41	42-44	45-46	47-49	50-52	53-55

How-to-Measure Information for Men and Women

Use a cloth tape measure to determine your correct size.

For Helmets, Caps or Hat Size — Measure completely around the head, starting approximately 1" above eyebrows in front and going around the largest point at the back of the head.

For Chest/Bust Size — Measure just under the arms, completely around the back and across the broadest part of the chest area. Hold tape firm and level. For body armor, see product description.

Neck — Measure a shirt that fits you well. Lay the collar flat and measure from the center of the collar button to the far end of the button hole. The number of inches equals your size.

Sleeve — Measure from the center of the collar (in the back), across the shoulder and down the sleeve. Number of inches equals sleeve length.

For Women's Hips — Stand with heels together and measure around fullest part of hips.

Inseam — Take a pair of uniform pants (not jeans) that fit you well. Measure (to nearest inch) from the crotch seam to the bottom of pants.

Belts — If between "even" sizes, order the next larger size. Order 2" larger than your waist size.

Gloves — Measure around hand at fullest part (exclude thumb). Number of inches equals glove size. Consult the chart given for the gloves you are ordering to convert inches to the size you need for that product.

Place of Sale

Galls reserves the right to accept or reject any and all orders, regardless of the manner in which the order is made. Orders become valid, and the sale shall be deemed made in Lexington, Kentucky, subject to the terms set forth herein, when accepted by Galls. Visit galls.com/Pages/TERMS for details.

State and Local Sales Taxes

Add applicable state and local sales tax percentages for location. The sales tax applied to a Galls purchase is determined according to state and local laws and regulations. The tax rate is based upon the orders shipped from and shipped to information. Visit galls.com/Pages/TAXINFO for details.

Restricted Items

Galls restricts the sale of select products by federal, state and/or local law. Galls is an authorized dealer of all the goods it offers for sale, but does not and cannot grant the right or authority to persons to purchase items which may be regulated pursuant to such laws. Orders for such products require shipping to authorized agency or official identification. Visit galls.com/Pages/TERMS for details.

Pricing in this Catalog

Typographic, photographic and/or descriptive errors are subject to correction. In the event of an error, Galls reserves the right to correct the error, including, but not limited to, right to cancel a processing order if the item is priced incorrectly. Merchandise prices and specifications are subject to change without notice. Prices are current upon receipt of this catalog and are good through 6/21/16 (unless otherwise noted). Promotional offers cannot be combined and are good while supplies last.

Mail List Preferences

Galls mailing list is made available to carefully screened companies whose products and services may be of interest. Visit galls.com/Pages/PRIVACY for details. To stop receiving such mailings, call 800.477.7766, change mailing preferences on the web (registered customers only), fax a copy to 800.944.2557 or send a copy of your mailing label to: P.O. Box 54308, Lexington, KY 40555. Note: Circulation updates require nine to 12 weeks to process.

Quality meets value
with our house brands:

DutyPro™

DYNAMED

GALLS®

Law★Pro®

QUARTERMASTER™

Outfitting Your Customization Choices Why Choose Galls?

- **Service:** Comprehensive range of services for public safety professionals
- **Convenience:** Ready-for-duty uniforms the moment they arrive at your door
- **Affordable:** Low prices to meet your budget
- **Selection:** Vast online inventory for a convenient and viable one-stop resource
- **Personalization:** In-house capabilities to customize apparel, hats and bags

Shirt Tailoring

Standard Embroidered Namestrips

Choose standard or ACU namestrips (see below) when you purchase your uniform, and we'll apply them **FREE!** We embroider all of them in-house so we can deliver them to you even faster.

For standard namestrips, choose the cloth strip/embroidery color combo. Limit of fifteen 1/2" characters. 1" H x 9" W.

\$5.39/ea

Cloth Strip Color

Black, Navy, Khaki, Olive, Brown

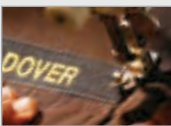
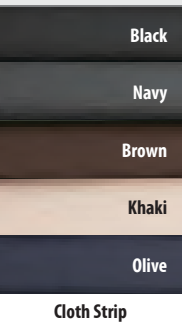

Digital Embroidered Namestrips

Namestrips for your ACU. Name appears in black embroidery. Limit 15 characters. VELCRO® brand backing. 1" H x 5" W.

6R1-UA6035 \$4.39/ea



1" H x 5" W

Nameplate Eyelets

Choose nameplate eyelets for a nice, sharp look.

Description	Item	Price
Embroidered	6R1-LL098	\$6.59
Metal	6R1-UA563	\$3.19

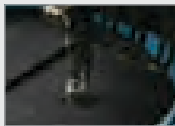

Buttons-to-Zipper Conversion

Found a shirt with all of the features that you want, but it doesn't come with a zipper front? Any button-front shirt that we offer can be converted to a convenient zipper front. An additional \$5.99 will be charged for labor.

6R1-UA562 \$7.59



Button Replacement

We can take your plastic buttons from any shirt and replace them with metal buttons — and they'll be ready to wear when they arrive at your door. Buttons sold separately.

6R1-LA100 \$8.99



Pocket Flaps & Epaulets

We can change the pocket flaps and epaulets on most uniform shirts for a two-tone option! Call for details and pricing.

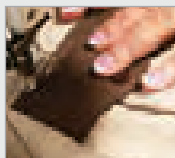

Three Easy Steps for Unrivaled Customization

1. Choose Your Product

We know how vital it is to set yourself apart with distinct identification. That's why we offer an extensive array of apparel, hats and bags that can be customized to meet your department's specifications.

2. Tell Us the Customization You Want

Galls offers a comprehensive line of personalization options. Choose embroidery, emblems, heat press or screen printing. You can even receive services like button replacement, nameplate eyelets and striping for those meticulous features that turn the ordinary into the extraordinary.

3. Call to Place Your Order

Our helpful representatives are available to answer all of your questions. They also make sure that they gather all of the crucial information needed for our talented and experienced customization team. That's when the magic begins, when your request is transformed into a viable product that exceeds expectations.

Questions? Call us at 800.477.7766

Pant Tailoring

FREE Hemming So Your Pants are Ready to Wear

Just tell us your inseam, and the experts on our uniform services team will give your pants the professional look you want. They'll be ready to wear when they arrive at your door. For most pants, we can sew inseams up to 35" for men and 32" for women.

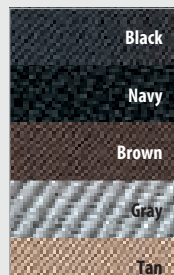
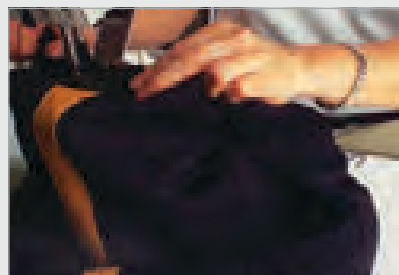
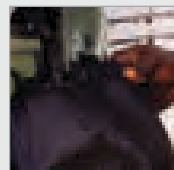

Striping

Simply order our cloth or braid striping option, and specify your choice of color (available on most uniform trousers). Colors and widths: See below and right.

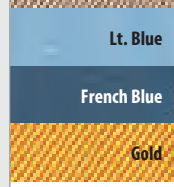
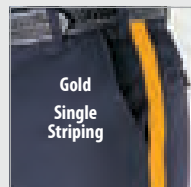

Description	Item	Price
1/2" Cloth	6R1-UA157	\$8.59
1" Cloth	6R1-UA158	\$10.89
1/2" Braid	6R1-UA159	\$8.59
1" Braid	6R1-UA160	\$10.89

Cloth Striping

Two-Tone Striping

For an extra-distinctive look, the experts on our apparel finishing team can add two stripes to each side of your pants, one stripe on top of another. Call for details.

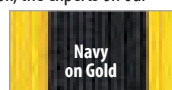

Two-Tone Striping

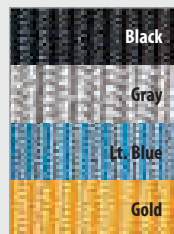

Braid Striping

Heat Press

Heat Press is a durable and affordable option for adding titles to just about any garment. Choose from reflective and non-reflective designs and titles; or create your own one-line or two-line custom titles. Reflective heat press is designed of 500 Candlepower of 3M™ Reflectivity.



Reflective Heat Press

500 candlepower of 3M™ reflectivity — designed for nighttime duties. Logos and wording can be placed on the front chest and on the back. All titles are offered in silver reflective color only.

- Same glass bead retro-reflective technology used in ANSI-compliant apparel; light reflects back to the source like vehicle headlights
- Designs and lettering are affixed to your apparel with heat for a permanent transfer
- Flexible reflective graphics won't peel or fade away

Left or right chest titles: Security, Police^(X), Sheriff^(X), Fire^(X), EMS.

Left or right chest title: 1"H x 4"W
6R1-HT037 \$8.79



Left or right chest design 6R1-HT035 \$8.79

Security	2½"H x 3½"W
Police	2½"H x 3½"W
6-Point Star	3¾"H x 3¾"W
Maltese Cross	3¾"H x 3¾"W
Star of Life	3¾"H x 3¾"W

Back Design 6R1-HT033 \$12.59

Security	4"H x 11"W
Police	4"H x 11"W
Sheriff	4"H x 11"W
Fire	4"H x 11"W
EMS	4"H x 11"W
Star of Life	7"H x 7"W



Chest Titles



Chest Designs



Back Designs

Back Reflective Heat Transfer Sets

Choose up to two lines. 1" letters can have up to 18 characters. 2" letters can have up to 12 characters. 3" letters can have up to eight characters.

6R1-HT002

1 Line	\$11.99
2 Lines	\$15.29



Non-Reflective Heat Press Titles

Recommended specifically for daytime use. You can place words in a variety of non-reflective ink colors on the front chest and on the back. Designs and logos are not available.

- Choose title, type size and color. Apply to front, back or both.
- No minimum number required
- Titles are affixed with heat for permanent transfer

Titles and Colors: SECURITY, POLICE^(X), SHERIFF^(X) — available in Black, White, Gold; FIRE^(X), EMS — Black, White, Red, Navy

Height	Item	Price
1"	6R1-HT048	\$7.69
2"	6R1-HT049	\$7.69
3"	6R1-HT050	\$11.99
4"	6R1-HT051	\$11.99



Screen Printing



Screen Printing

Screen Printing of titles or designs is more economical than embroidery — and with less limitations than heat press. You can even screen print polyester. Option is available on selected polos, casual shirts, T-shirts, bags, rainwear and outerwear. Screen printing can handle almost any design, with a durable and long-lasting result. *Call for details and pricing.*

(X) Visit us online for restricted item info.

FREE Hemming

Look sharp in a custom fit. Whether you require a complex fitting or our **FREE** hemming service, let our tailors handle the work for you.

Customize with Emblems and Receive a

Emblems

Applied **FREE**

We stock a wide selection of emblems, as well as having the capability of producing your custom emblem. Call us today for details.

We know you're busy — you don't have time to run to a tailor and have them apply a professional emblem to your uniform. That's why our uniform experts apply emblems of your choice **FREE** at the time of purchase to almost any garment that you buy from us. Check out our wide selection of emblems online.

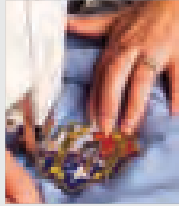

Gold on Navy

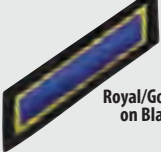

Royal/Gold on Black



Gold on White



Gold on Navy



Royal/White on Black



Gold on Black

Chevrons

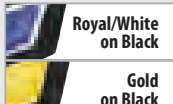

Royal/White on Black



Gold on Black



Royal/Gold on Black



Dark Gold on Black



White on Black

Hash Marks

Description	Dimensions	Item	Price
Private	2½"H x 2¾"W	6R1-UA123	\$1.06
Corporal	3¼"H x 3"W	6R1-UA124	\$1.59
Sergeant	3¾"H x 3"W	6R1-UA125	\$2.19

Hash Marks	Price
(½"H x 2½"W)	6R1-UA008
	\$0.99

Lapel Emblems

Specify color, stitching color and insignia.

Titles: Private, Corporal, Sergeant, Second Lieutenant, First Lieutenant, Captain, Major, Lieutenant Colonel and General. 1"H x 1"W.

6R1-UA481
\$4.19/pr

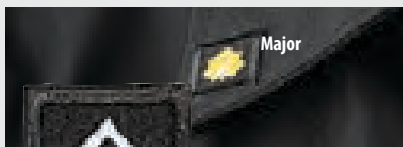

Major

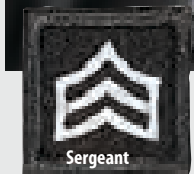

Sergeant

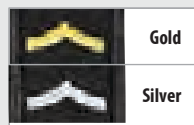

Gold

Silver

Stitching

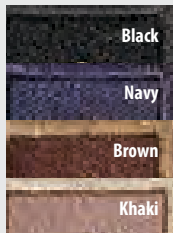

Black

Navy

Brown

Khaki



Hero's Pride Infrared Uniform Identification

Infrared uniform identification with VELCRO® brand attachment.

\$14.09

A) Standard US Flag	2½"H x 3½"W	6R1-UA878
B) Reverse US Flag	2½"H x 3½"W	6R1-UA879
C) Blood Type	1"H x 2"W	6R1-UA881

A

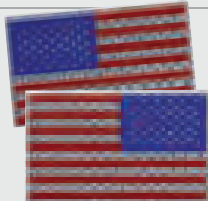

B

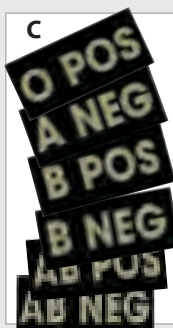

C



Reflective Options

Standard and Subdued Flags (2"H x 3¼"W) \$2.19

D) Left Sleeve Gold Border	6R1-UA155
E) Right Sleeve Gold Border	6R1-UA156
F) Left Sleeve Subdued	6R1-UA467
G) Right Sleeve Subdued	6R1-UA490
H) Left Sleeve White Border	6R1-UA524
I) Right Sleeve White Border	6R1-UA440

Reflective Flags (2¼"H x 3¾"W) \$4.29

Left Sleeve Gold Border	6R1-UA255
Right Sleeve Gold Border	6R1-UA248

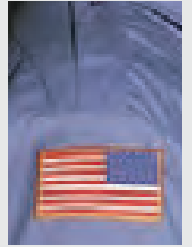

In-Stock Badge Emblems

Available in a variety of titles. Specify Silver or Gold.

Standard \$4.29

J) Sheriff ^(X)	3¾"H x 3½"W	6R1-UA176
K) Police Officer ^(X)	3¾"H x 2½"W	6R1-UA180
L) Bike Patrol ^(X)	3¾"H x 2½"W	6R1-UA177
M) Security Officer	3¾"H x 2½"W	6R1-UA183
N) Public Safety	3¾"H x 2½"W	6R1-UA596

Reflective \$5.39

Sheriff (Silver only) ^(X)	3¾"H x 3½"W	6R1-UA146
Police Officer ^(X)	3¾"H x 2½"W	6R1-UA142
Security Officer	3¾"H x 2½"W	6R1-UA145
Public Safety	3¾"H x 2½"W	6R1-UA597

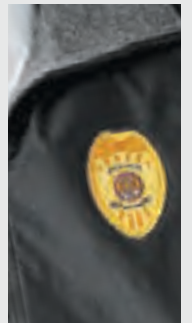

White on Black

Medium Gold on Black

Standard Back Emblems

Titles/Colors: Police^(X) – Medium Gold on Black, White on Black, Gray on Black; Sheriff^(X) – Medium Gold on Black, Dark Gold on Brown; Security – Medium Gold on Black, White on Black, Medium Gold on Navy. 4"H x 11"W.

6R1-UA528 \$5.39

Medium Gold on Black
White on Black
Medium Gold on Navy
Gray on Black
Dark Gold on Brown
Check descriptions for availability

Reflective Back Emblems

Titles: Police^(X), Sheriff^(X), Security, Firefighter^(X), Fire Dept.^(X), Fire Rescue^(X), EMS and Public Safety. 4"H x 12"W.

6R1-UA332
\$14.09



FREE Application



Standard Emblems

Our uniform experts will apply emblems of your choice **FREE** at the time of purchase to almost any garment you buy from us. Specify emblem number and color where required.

\$4.29

O) Police Shield ^(X)	3¾"H x 2⅞"W	6R1-UA016
P) Explorer ^(X)	4"H x 4"W	6R1-UA527
Q) Security Officer	3¾"H x 4¾"W	6R1-UA526
R) Security Officer	3¾"H x 2⅞"W	6R1-UA015
S) Security Officer	3½"H x 4¼"W	6R1-UA137
T) Security/Eagle	4¼"H x 3¾"W	6R1-UA139
U) Security/Eagle	4"H x 4"W	6R1-UA294
V) Security/Eagle	3½"H x 3½"W	6R1-UA271
W) Fire Dept./Scramble ^(X)	4"H x 4"W	6R1-UA281
X) First Responder	3½"H x 3½"W	6R1-UA126
Y) Private Security	4"H x 4¾"W	6R1-UA246
Z) Crime Prevention	4"H x 4¾"W	6R1-UA243

(X) Visit us online for restricted item info.

VISIT US ONLINE



For a full selection of emblems and morale patches, visit galls.com/emblems-patches

Ordering online? Use your **PROMOTIONAL CODE** from the back cover

Stand Out With a Custom Design

Set yourself apart with a unique emblem or exclusive embroidered design. When public safety professionals arrive at the scene, a customized emblem immediately identifies them as authority to civilians and to other public safety agencies. Let us help you distinguish yourself in a sea of uniforms with custom authority. Call 800.477.7766 today to find out how you can outfit your entire department.



Emblems

Submit your design, and we'll take care of the rest. From a sketch to finished artwork, we can customize an emblem to your specifications. We'll even send an existing emblem to you for approval. Emblems are available in several options (see below).



Embroidered

Highlights traditional emblem construction with raised detailing and a shiny finish



Inkjetted

Provides more flexibility with details and color gradation



Woven

Allows for more detailing, including smaller lettering



Combination

Combines the fine detail available with a woven emblem, but with the classic raised features of traditional embroidery

Embroidery

Complete your look with custom embroidery for a more flexible, comfortable option. Please supply finished artwork. Some restrictions apply.

Call us today at 800.477.7766 to start.

Questions?

Our knowledgeable and helpful customer service representatives are available Monday-Friday, 8:00 a.m. - 9:00 p.m. ET. Call 800.477.7766 to place an order, ask a question or learn more about our products.

800.477.7766 • galls.com

103

Embroidery



Embroidering your apparel adds a personal and professional appearance



Automated machines can outfit your entire department with uniform designs



Create precise designs

One of the things that sets us apart from our competitors is our in-house customization capabilities. We know how important it is for your uniform to look exactly right — and as a busy public safety professional, you don't have time to run to the tailor or embroidery shop. That's where we step in for you: We take care of the details so your uniform is ready for duty when you receive it!

Embroidered Designs

Right Chest Personalization

Left Chest Personalization



Chest Personalization

Embroider up to three lines of messaging on left or right chest (all caps: 15 characters/spaces each line, or mixed caps: 22) stitched onto any garment that accepts embroidery. You can also choose block or script lettering. Designs may also be embroidered on your shirt chest.

Description	Item	Price
Right Chest, 3 Lines	6R1-PEC03	\$9.79
Left Chest, 3 Lines	6R1-LL3LN	\$9.79
Right Chest, 2 Lines	6R1-PEC02	\$8.79
Left Chest, 2 Lines	6R1-LL2LNM	\$8.79
Right Chest, 1 Line	6R1-PEC01	\$6.59
Left Chest, 1 Line	6R1-LL1LNM	\$6.59

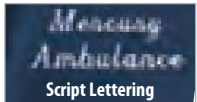

Back Designs

Add a back design to your apparel or outerwear purchase. Choose from Star of Life, Maltese Cross, or one of five shield designs: Police Officer^(X), Security Officer, Corrections Officer^(X), Communications Officer or Military Police^(X). Each comes with 20 characters/spaces around it. Gold or Silver.

\$29.49

- A) Star of Life **6R1-PED03**
- B) Shield^(X) **6R1-PED14**
- C) Maltese Cross^(X) **6R1-PED04**



Block Lettering

Add large block letters to the back of your apparel or outerwear purchase.

Top row: twelve 1" character/spaces; **Bottom row:** ten 2" character/spaces.

6R1-PED00 \$29.49

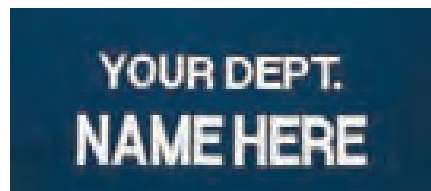

for Apparel, Hats and Bags

Collar Personalization

Personalize the collar of your turtleneck, mock turtleneck or dickie.



Half-Inch Embroidered Initials

Choose up to four 1/2" initials on the left side of the neck.

6R1-PEH00 \$5.49



Embroidered Designs

Choose Shield, 5-, 6- or 7-Point Star, all in Gold or Silver; or Fire Scramble; or Star of Life in Black, Navy, Royal, White, Silver or Gold for the right side of the neck. Specify design and color.

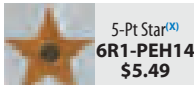
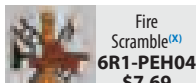
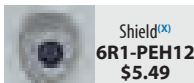

Cap Personalization

Display your authority on a ball cap. Embroider your cap on the front, back, strap or in all three places. For design options, see right.

For the **front**, you receive one or two lines of embroidery. For **two lines**, choose up to twelve 1/2"H block letters on the top line; up to ten 1"H block letters on the bottom line. For **one line**, select up to ten 1/2"H block letters or 1"H block letters.

For **back** and **wrap strap**, specify up to 10 characters/spaces of 1/2" embroidered lettering.

Description	Item	Price
Front, 2 Lines	6R1-LL2LNH	\$8.79
Front, 1 Line	6R1-LL1LNH	\$6.59
Cap Back	6R1-PEB02	\$7.69
Wrap Strap	6R1-PES01	\$7.69



Bag Personalization

Quickly identify your gear with a design, lettering or both! Add initials only (max four) or up to two lines of letters.

One line: 20 letters/spaces max. **Two lines:** top 12 letters/spaces max, bottom 10 letters/spaces max. Block or script. Heat press option available on some bags, see p. 139. Distinctive Graphic Designs available on right.

Description	Item	Price
2 Line	6R1-LL2LNB	\$8.79
1 Line	6R1-LL1LNB	\$6.59
1" Initials	6R1-PEH01	\$5.49
1/2" Initials	6R1-PEH00	\$5.49



Just a sampling of the many design options we have ready to stitch for you!

\$8.79

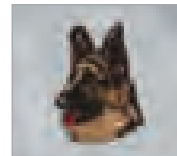

Distinctive Graphic Designs

With each design you also receive up to 20 characters/spaces of embroidered block lettering surrounding your design, all for one low price. Personalization is sewn in complementary colors to your garment. **Note:** Indicate if graphic design is being applied to apparel, hat or bag when ordering. Allow three to five days for delivery of customized garments.

(X) Visit us online for restricted item info.



Nameplates Complete Your Uniform



Standard Nameplates 2 1/2" W

A) 3/8" 1-Line	6R1-NT004	\$9.19
B) 1/2" 1-Line	6R1-NT033	\$9.99
1/2" 2-Line	6R1-NT035	\$11.19
5/8" 1-Line	6R1-NT017	\$9.99
C) 5/8" 2-Line	6R1-NT018	\$11.19

Applied State Seal Nameplates 2 1/2" W x 5/8" H (specify state)

D) 1-Line	6R1-NT039	\$11.19
E) 2-Line	6R1-NT040	\$12.19

Laser Engraved Emblem Nameplates 2 1/2" W x 5/8" H

F) 1-Line Maltese Cross	6R1-NT037	\$11.19
2-Line Maltese Cross	6R1-NT038	\$12.19
1-Line Star of Life	6R1-NT049	\$11.19
G) 2-Line Star of Life	6R1-NT050	\$12.19

Applied Emblem Seal Nameplates 2 1/2" W x 5/8" H

H) 1-Line Fire Scramble	6R1-NT056	\$11.19
2-Line Fire Scramble	6R1-NT057	\$12.19
1-Line Star of Life	6R1-NT023	\$11.19
I) 2-Line Star of Life	6R1-NT031	\$12.19

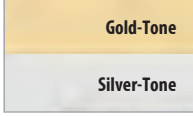

Blackinton

Blackinton® Premium Nametags

The Blackinton® quality you know and trust — made the way you want.

- Choice of 1 or 2 lines of engraving
- 20 letters/spaces per line
- Choice of polished gold or polished silver
- Choice of ink color: black, red or blue
- Choice of pin back or clutch back
- 2 1/2" W — available in two heights

Description	Item	Price
J) 1/2" 1-Line	6R1-NT095	\$13.30
1/2" 2-Line	6R1-NT096	\$13.30
5/8" 1-Line	6R1-NT097	\$13.30
K) 5/8" 2-Line	6R1-NT098	\$13.30



How to Order Engraved Nameplates

1. Specify nameplate item number
2. (A through K only) Choose polished for smooth, shiny finish or brushed for a matte finish
3. Choose gold, silver or chrome finish with black, blue or red letters
4. Tell us the exact number of letters and spaces for the nameplate
 - With design, you receive 15 letters/spaces per line
 - Without design, you receive 20 letters/spaces per line
5. Select a pin, clutch or magnetic back



(PB) Pin Back: Safety Pin Style



(CB) Clutch Back: 2 Prongs with Clamps



(MB) Magnetic Back



Smith & Warren® Serving Since Attachment

Individual attachment fits any clutch back nameplate on the facing page. Choose polished Gold or Silver-Tone finish. (Does not match the brushed matte finish). Choose your color, finish and year.

6R1-NT026 \$12.19

Not compatible with pin or magnetic backs



Smith & Warren® #C600 One-Piece Nameplate

Nametag and "Serving Since" pin all in one piece. Choose your color, finish and year. 2 1/2" W x 3/8" H. Specify personalization.

6R1-NT007	
Silver-Tone	\$24.00
Gold-Tone	\$29.50



I.D. and Awards Stay Safely in Place

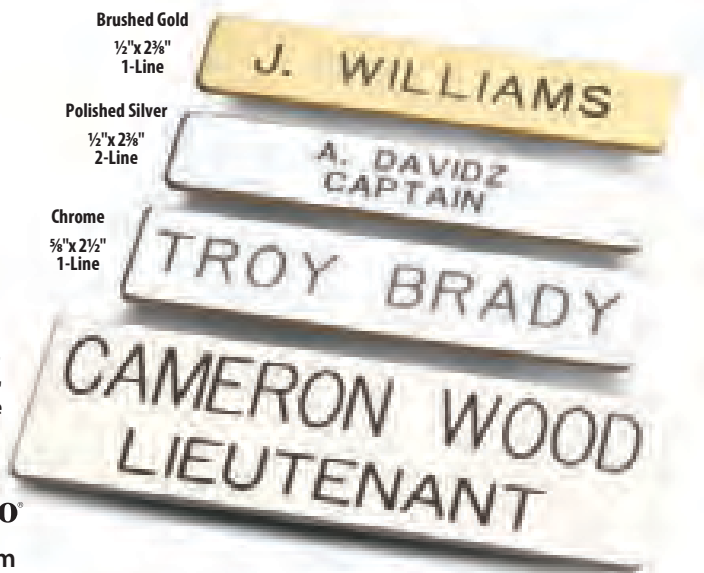

Brushed Gold
½" x 2¾"
1-Line

Polished Silver
½" x 2¾"
2-Line

Chrome
⅝" x 2½"
1-Line

Silver
1" x 3"
2-Line



LawPro® Custom Engraved Nameplates

- Includes military clutch backings
- Clearly specify your name and/or title/rank
- No minimum quantity required

Item	Size (HxW)	Price	Lines	Color			Finish	
				Gold	Silver	Chrome	Brushed	Polished
6R1-NT132	½" x 2¾"	\$8.79	1	X	X		X	X
6R1-NT133	½" x 2¾"	\$10.19	2	X	X			X
6R1-NT150	½" x 2¾"	\$11.99	1			X	X	X
6R1-NT151	½" x 2¾"	\$11.99	2			X		X
6R1-NT148	⅝" x 2½"	\$9.99	1			X	X	X
6R1-NT149	⅝" x 2½"	\$9.99	2			X		X
6R1-NT143	1" x 3"	\$9.99	1	X	X			
6R1-NT144	1" x 3"	\$10.99	2	X	X			
6R1-NT145	1" x 3"	\$12.99	3	X	X			

QUIK-PIN®

Quik-Pin® DAMMITs

Keep your ribbons and badges in place with an alternative to the traditional brass clasp.

- Smooth polymer retainers are comfortable and lightweight



6R1-BC942 **\$5.39**/6 pk

Klench Nametag Fasteners

Klench fasteners are made of tough polyurethane, and designed to hold posts tightly and securely.

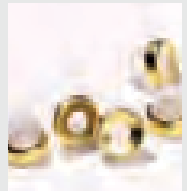

6R1-NT002 **\$9.39**/6 pk

Go from sloppy... ... to sharp and precise

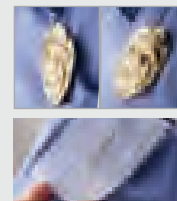

Easily customizes to any configuration

QUIK-PIN®

Quik-Pin® Universal Badge & Ribbon Bar Template/Backplate

Engineered to contour to your body, this Quik-Pin Universal template is the easy solution for displaying your awards and badges.

- Adds rigid backboard to thin uniform shirts for a sharp finish
- Easily customizable using the grooved "waffle" grid to cut holes
- Saves time and ensures your badge and bars are positioned correctly

5¼"H x 4"W

6R1-BC941 **\$8.59**



LawPro® Mourning Bands

Black elastic ½" Mourning Band fits around any badge.

6R1-BD292

Quantity	Price
12 pack	\$9.59
50 pack	\$31.69
100 pack	\$52.79

Designed for Galls by Blackinton



American Flag



Flag Commendation

Blackinton

In-Stock Commemorative Lapel Pins

Description	Item	Price
American Flag	6R1-CB162	\$3.00 /ea
Flag Commendation	6R1-CB164	\$7.20 /ea



Handcuff



Fire Dept.

Blackinton

Blackinton® Tie Bars

Show pride in your profession with uniform accessories designed by Blackinton®. Includes a spring clip attachment. ⅞"H x ¾"W. Finishes: Gold and Silver.

\$9.20

Description	Size	Item
Handcuff	½"H x 1"W	6R1-JW038
Fire Dept.	⅞"H x ¾"W	6R1-JW036

Your Rank and Collar Brass Headquarters

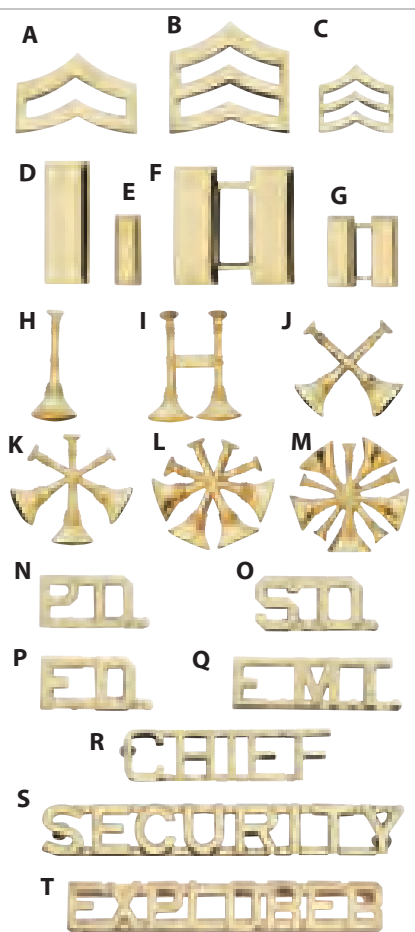

Blackinton

Blackinton® Collar Brass

Insignia and Pins include clutch back attachments. Finishes: Silver Plate and Gold Plate.

Insignia

A) Large Corp. Chevron	6R1-CB041	\$7.20/pr
B) Large Sgt. Chevron	6R1-CB043	\$7.20/pr
C) Small Sgt. Chevron	6R1-CB040	\$7.20/pr
D) Large Lieut. Bar	6R1-CB044	\$7.20/pr
E) Small Lieut. Bar	6R1-CB050	\$7.20/pr
F) Large Capt. Bar	6R1-CB046	\$7.20/pr
G) Small Capt. Bar	6R1-CB052	\$7.20/pr
H) Single Bugle	6R1-CB056	\$6.50/pr
I) Double Bugle	6R1-CB057	\$6.50/pr
J) 2 Crossed Bugle	6R1-CB058	\$6.50/pr
K) 3 Crossed Bugle	6R1-CB059	\$6.50/pr
L) 4 Crossed Bugle	6R1-CB060	\$6.50/pr
M) 5 Crossed Bugle	6R1-CB061	\$6.50/pr

Collar Pins

N) Police Dept. (X)	6R1-CB066	\$8.30/ea
O) Sheriff's Office (X)	6R1-CB090	\$8.30/ea
P) Fire Dept. (X)	6R1-CB001	\$8.30/ea
Q) EMT	6R1-CB002	\$8.30/ea
R) Chief	6R1-CB063	\$9.40/ea
S) Security	6R1-CB068	\$9.40/ea
T) Explorer	6R1-CB137	\$9.40/ea

Insignia starting at
\$4.05



LawPro® Metal Rank Insignia

Insignia includes clutch back attachments. Finishes: Nickel and Gold Plate.

Description	Item	Price/pr	Description	Item	Price/pr
A) Private Small	6R1-CB530	\$4.05	Private Large	6R1-CB531	\$7.69
B) Corporal Small	6R1-CB504	\$5.57	Corporal Large	6R1-BD252	\$7.59
C) Sergeant Small*	6R1-CB508	\$5.57	Sergeant Large*	6R1-CB508	\$7.69
D) Lieutenant Small	6R1-CB505	\$7.69	Lieutenant Large	6R1-BD255	\$8.39
E) Captain Small*	6R1-CB503	\$8.79	Captain Large*	6R1-CB503	\$9.89
F) Oak Leaf Small*	6R1-BD261	\$8.79	Oak Leaf Large*	6R1-BD261	\$9.89
G) Eagle Small	6R1-BD254	\$8.99	Eagle Large	6R1-BD310	\$9.99
H) 1 Star Small**	6R1-CB518	\$11.79	1 Star Large**	6R1-CB518	\$11.79
I) 2 Star Small**	6R1-CB518	\$14.99	2 Star Large**	6R1-CB518	\$19.19
J) 3 Star Small**	6R1-CB518	\$16.99	3 Star Large**	6R1-CB518	\$26.69
K) 4 Star Small**	6R1-CB518	\$21.39	4 Star Large**	6R1-CB518	\$31.99
L) 5 Star Small (circle)	6R1-CB519	\$28.39			

*Specify size. **Specify size and title.

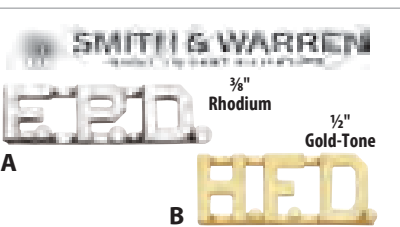

Smith & Warren® Custom Collar Brass

Available in 1/2" or 3/8" size. Clutch back style. Specify letters. For 12 or more pairs, call for quantity discounts. Finishes: Gold-tone and Rhodium.

Description	Item	Price
2-Letter 3/8"	6R1-CB177	\$18.99/pr
2-Letter 1/2"	6R1-CB174	\$18.99/pr
A) 3-Letter 3/8"	6R1-CB074	\$19.99/pr
B) 3-Letter 1/2"	6R1-CB175	\$19.99/pr
4-Letter 3/8"	6R1-CB120	\$20.99/pr
4-Letter 1/2"	6R1-CB176	\$20.99/pr



Blackinton Recognition Medal

Medals are presented in a rich, dark blue velour case with a matching commendation bar. Measures 1 1/2" H x 1 1/2" W. Call for customization.

Description	Item	Price starting at
1/16" Seal	6R1-BC440	\$63.00
1/2" Seal	6R1-BC439	\$63.00

(X) Visit us online for restricted item info.

In-Stock Badges, Outstanding Craftsmanship



LawPro®

LawPro® In-Stock Badges

Pin back. Finishes: Gold or Silver.

Starting at
\$13⁸⁹



Pin Back

VISIT US ONLINE



Shop our full selection of badges and ID accessories online at:
galls.com/badges-insignia-customization

Description	Type	Size	Item	Price
Security Officer with Lion	Hat	3" x 2¼"	6R1-BD266	\$14.09
A) Security Officer with Lion	Chest	3" x 2¼"	6R1-BD267	\$14.09
Security Officer with Enameled Shield	Hat	2¼" x 1½"	6R1-BD264	\$15.99
B) Security Officer with Enameled Shield	Chest	2¼" x 1½"	6R1-BD265	\$15.99
C) Security Officer Star in Circle	Chest	2¼" x 2¼"	6R1-BD251	\$22.19
D) Security Officer Eagle in Circle	Chest	2¼" x 2¼"	6R1-BD313	\$22.19
E) Oval Security Enforcement Badge	Chest	3" x 2¼"	6R1-BC011	\$22.32
F) LAPD-Style Security Officer (Silver Only)	Chest	3¾" x 2½"	6R1-BD245	\$27.69
G) LAPD-Style Security Enforcement Officer (Silver Only)	Chest	3¾" x 2½"	6R1-BD302	\$27.69



LawPro®

LawPro® Quality Badges

Pin back. Finishes: Gold or Silver.

Lite: Approximately 40% lighter than Deluxe Badges.

\$16.29

Deluxe: Traditional weight and outstanding craftsmanship.

\$22.19



Pin Back

Description	Size	Lite Badge Item	Deluxe Badge Item
H) Security Enforcement Officer	3" x 2¼"	6R1-BD256	6R1-BD253
I) Security Officer with Black Panels	3" x 2½"	6R1-BD257	6R1-BD054
J) Security Officer with Enameled Seal	3" x 2¼"	6R1-BD259	6R1-BD408
K) Security Officer 7-Point Star	3" x 3"	6R1-BD312	6R1-BD306
L) Security Officer 6-Point Star	3" x 3"	6R1-BD258	6R1-BD305
M) Security Special Officer 7-Point Star	3" x 3"	6R1-BD311	6R1-BD304
N) Security Officer Hat Badge	2½" x 2½"	—	6R1-ZA2023
O) Private Security Officer	4" x 2"	—	6R1-BD323
P) Crime Prevention Officer	4" x 2"	6R1-BC014	
Q) Loss Prevention Officer	4" x 2"	6R1-BD271	



Ordering online? Use your **PROMOTIONAL CODE** from the back cover

800.477.7766 • galls.com

109

Custom and In-Stock Badges

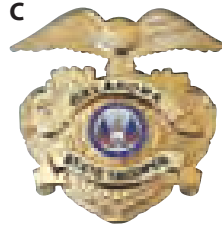
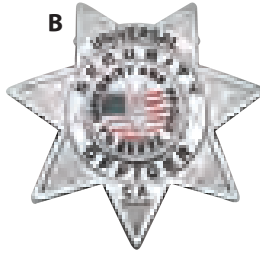

LawPro® Custom Badges

Custom badges feature a lacquered finish and deluxe backing with a one-year guarantee against defects.

- Finished in high-quality Gold or Nickel electroplate
- Engraved and filled lettering
- Hard enameled seal
- Delivery: Approximately six weeks
- Minimum order: six badges

When ordering Custom Badges, please specify the following information:

1. Center Seal: (See examples)
2. Finish: Gold or Nickel
3. Fastener: Pin (Breast) or Screw Back (Hat)
(See examples)
4. Lettering: Blue or Black

Buy More and Save

Badges A - E Shown

Quantity	Price/ea
200+	\$33.22
100-199	\$35.43
50-99	\$37.45
13-49	\$39.86
6-12	\$44.29

Badges F - I Shown

Quantity	Price/ea
200+	\$41.54
100-199	\$44.31
50-99	\$47.08
13-49	\$49.85
6-12	\$55.39

Description	Size	Item
A) Bald Eagle with Sunrays	3½" x 2¼"	6R1-BC205
B) Star with Top Banner	3" x 3"	6R1-BD707
C) Eagle	2½" x 2½"	6R1-BC911
D) Eagle over Shield	3½" x 2¼"	6R1-BC163
E) 7-Point Star Badge	3" x 3"	6R1-BC157
F) LAPD-Style Badge	3¾" x 2½"	6R1-BD710
G) 6-Point Star Badge	3" x 3"	6R1-BD720
H) Deluxe Oval	3" x 2¼"	6R1-BD711
I) Shield with Flags Badge	3" x 2¼"	6R1-BC156

Center Seal Examples



Fastener Examples

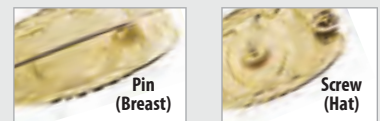

Galls® In-Stock Badges

They come with the wording exactly as shown, so they are ready to ship and very affordable. Personalization is not available. Pin back. Finishes: Gold or Silver Badges.

\$21.39

Description	Size (HxW)	Item
J) EMT	3" x 2½"	6R1-BC003
K) Volunteer Firefighter	3" x 2½"	6R1-BC001
L) Firefighter Fire Rescue	2¾" x 1¾"	6R1-BC354
M) Fire Rescue	3" x 2½"	6R1-BC118

FREE Emblem Application

Our uniform experts will apply your emblems for **FREE**, at the time of purchase, to almost any garment you purchase from us.

Online Badge Design and Customization

Our online interactive features give you virtually endless possibilities for designing a badge that will properly represent your authority. With our easy three-step process of design, preview and order, building a badge has never been more convenient. If you have any questions, our exceptional team of representatives is here to help.

Blackinton

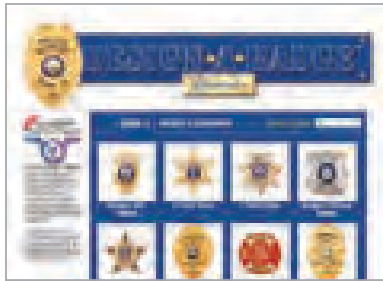

SMITH & WARREN
Built With Care. Worn With Pride.

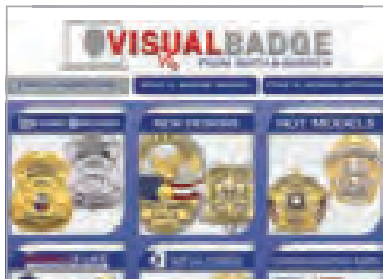

Ordering Instructions for Cases and Wallets No Minimum Order!

2½" Dia Round

3¾" H x 2¼" W Oval

3½" H x 2½" W Shield

In-Stock Styles: When you need your badge case or wallet fast, specify one of our three in-stock badge cut-outs.

Custom-Fit Styles: Order your leather badge case or wallet with a custom cut-out to perfectly fit your badge. They can accommodate both Blackinton and Smith & Warren badges. Just tell our customer service representative the model number of your badge, or send a photocopy of your badge's actual size. Custom badge cases are ordered from the factory and shipped separately from badges.

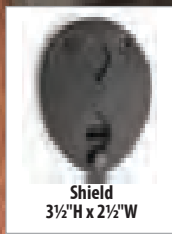

Shield
3½"H x 2½"W

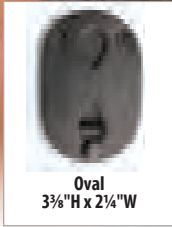

Oval
3¾"H x 2¼"W

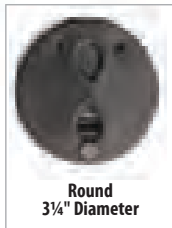

Round
3¼" Diameter



Galls® Clip-On Black Leather Badge Holder

Top-quality, smooth front with snap closure that secures badge in place.

- Metal clip on back fastens holder to your belt or pocket and makes it easy to slip badge on or off
- Eyelets for optional chain to wear around your neck
- Choose from round, oval or shield to accommodate your badge style

6R1-BC246 \$7.99



Clip on back



LawPro®

LawPro® Leather Badge Holder

Top-grain leather badge holder can be worn around the neck or clipped onto your belt.

Black. Styles: (Star, Shield) with belt clip. (Oval) with neck chain

6R1-BC825 \$10.89



STRONG
Badge Cases, Wallets & ID Products

Strong™ Clip-On Recessed Badge Holder (Double-Thick)

This custom-cut badge holder easily clips onto your belt for undercover or covert wear. Genuine leather; oval shaped

- VELCRO® brand closure to easily add badge; unique pocket to store chain
- Size varies according to badge number or customization

6R1-BC703 \$23.29

PERFECT FIT SHIELD WALLET

Perfect Fit Recessed Neck Badge & ID Holder with 30" Chain

This popular model can be worn two ways: around the neck or around your belt using VELCRO® brand fastener.

- Super double-polished, soft 18-gauge plastic reduces scratching, cracking and discoloration
- VELCRO® brand closure with 30" chain
- Holds ID size up to 2½" x 3¾" and badge width up to 2¾"

6R1-BD026 \$18.29



Perfect Fit Pocket Chain Recessed Belt Clip with Badge Holder

Recessed leather badge holder features metal clip, 30" chain and VELCRO® brand fastener.

- Badge is recessed into leather
- Chain tucks conveniently into a hidden pocket
- Wear around your neck on 30" chain or fits up to a 2" belt

6R1-BD023 \$19.17





Galls® Universal Leather Holder

Clip it on your belt or wear it around your neck with included 32" chain. Cover has VELCRO® brand closure. 4"H x 2¼"W

6R1-BC004 \$11.99



Galls® Ballistic Nylon Wallet with Neck Chain

Versatile wallet is an exceptional value!

- Photo insert
- 32" neck chain
- VELCRO® brand closure keeps valuables secure
- Business and credit card window
- Holds IDs up to 3¾" x 3" and badges up to 2¾"

4½"H x 3½"W closed

6R1-BC137 \$16.99



Badge Cases, Wallets & ID Products

Strong™ Clip-On Recessed Badge Holder

Designed for use with flat badges.

- Single layer of leather in recessed area
- VELCRO® brand closure to easily add badge

Made in the USA. Colors: Black and Brown

Without chain 6R1-BC714 \$1649+

With chain: Hang badge around neck or clip on your belt.

Unique pocket to store chain

6R1-BC704 \$17.89

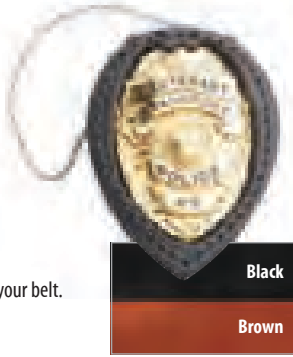

Black

Brown



Galls® Nylon Neck Badge/ID Holder

ID display is on one side, and your badge pins easily on the other.

- Stretch cord for hanging around neck
- Clear plastic window for easy view of ID; VELCRO® brand closure at the bottom of case

3¾"H x 4½"W

6R1-BC314 \$9.69



BLACKHAWK® CIA ID Lanyard

Includes a patented two-sided smart card holder. Cards slide in quickly, lock into place and can be easily removed.

- 5 mm lanyard with detachable 3 mm rope end and safety breakaway
- Card holder protects up to 2 access cards and provides durable security with ease of use
- Includes a clear vinyl pouch for additional ID needs

4"H x 3"W

6R1-BC838 \$16.99

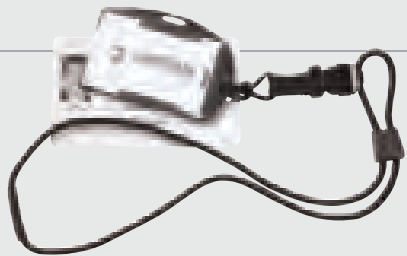

LawPro® Nylon Badge Wallet with Removable Badge Insert

Badge wallet holds most any size Police or Security shield.

- Tough Cordura nylon
- Removable badge insert
- 4 separate compartments to organize papers and cards
- Includes plastic picture holders and VELCRO® brand closures

6R1-BD325 \$16.29



\$15.99

PERFECT FIT SHIELD WALLETS

Perfect Fit Duty Book Style Leather ID and Badge Case

This duty book-style leather ID and badge case features rounded corners for comfort.

- Book-style ID with rounded corners
- Suede flap protects badge finish and ID
- Holds ID size up to 2½" x 4" and badge width up to 2¾"

4½"H x 3¼"W closed. See ordering instructions on p. 111

6R1-BD027 \$17.29



Galls® Book Style Leather Badge Case

Why carry a bulky wallet when you don't have to? Folds to less than ½" thick.

- Suede flap protects badge and vinyl ID window
- Fits IDs up to 2¾" x 4" and badges up to 2¾"

4½"H x 3½"W closed. See ordering instructions on p. 111

6R1-BC255 \$19.59



Galls® Traditional Dress-Style Leather Wallet

Book-style wallet with turned edges, smooth leather finish and recessed badge cut-out.

- Deep money compartment
- Suede flap protects ID window and badge finish
- Holds IDs up to 4" x 2¾" and badges up to 2¾"

4½"H x 3½"W closed. See ordering instructions on p. 111

Description	Item	Price
In-Stock	6R1-BC260	\$24.99
Custom Fit	6R1-BC261	\$26.59



VISIT US ONLINE

Shop our large offering of badge and ID holders, wallets and cases at: galls.com/badges

Protect Your Cash, Credit and ID



Galls® Classic-Style Leather Concealable Badge Wallet

Bi-fold look with innovative design. ID flap folds over badge opening.

- 2 deep money compartments and 3 credit card inserts
- Removable badge insert
- Holds IDs up to 4" x 2¾" and badges up to 2¾"

4"H x 5"W closed. See ordering instructions on p. 111



Description	Item	Price
In-Stock	6R1-BC197	\$30.49
Custom Fit	6R1-BC202	\$31.99

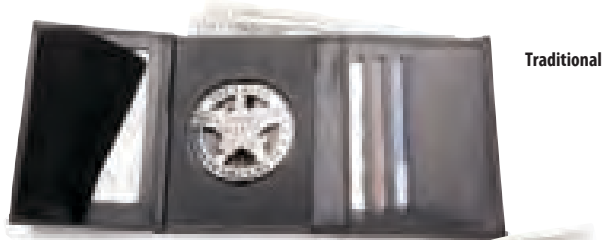

Traditional

Compact



Galls® Tri-Fold Leather Badge Wallet

Wallet features deep money compartments and six credit card slots.

- Suede flap protects ID window and badge finish
- Traditional fits IDs up to 2¾" x 4" and badges up to 2¾"
- Compact fits IDs up to 2" x 3" and badges up to 1½"

Traditional: 4½"H x 3½"W closed. Compact: 4"H x 3¾"W closed. See ordering instructions on p. 111

Description	Item	Price
Traditional Size	6R1-BC248	\$25.39
Compact Size	6R1-BC005	\$28.89



Badge remains hidden until wallet is fully open

Protect Your Identity and Money with an RFID Blocking Wallet

Many credit card companies put RFID chips in your cards, sometimes without your knowledge. Savvy thieves can access the information on those chips, even when your cards are "safely" secured in your wallet. Our RFID Blocking Wallets specifically inhibit radio frequencies in chips from escaping until you pull out your card. Each wallet is lined with fabric designed to block RFID transmissions. Don't get caught unprotected. Watch this feature's video online.

PERFECT FIT SHIELD WALLET

Perfect Fit Dress Leather Recessed Badge and Single ID Cases

Thin, lightweight design with folded edges to complete your professional off-duty attire.

- Super double-polished, soft 18-gauge plastic reduces scratching, cracking and discoloration
- Suede flap protects badge finish and ID
- Holds ID size up to 2¾" x 4¼" and badge width up to 2¾"



Description	Item	Price
Original	6R1-BD030	\$20.89
with RFID	6R1-BD085	\$30.99

Perfect Fit Recessed Badge Wallet with Credit Card Slots & ID Window

Plenty of room for currency and credit cards.

- Double-polished, soft 18-gauge plastic reduces scratching, cracking and discoloration
- Flipping ID window and suede flap protects badge finish and ID
- Holds ID size up to 2½" x 4" and badge width up to 2½"



Description	Item	Price
Original	6R1-BD024	\$35.99
with RFID	6R1-BD079	\$45.99



Galls® Classic Style Bi-Fold Badge Wallet

Wallet features rounded corners to better fit your pocket.

- 2 money compartments and 6 credit card slots
- Suede flap to protect badge
- Holds IDs up to 4" x 2¾"
- Holds badges up to 2¾"

3½"H x 4½"W closed. See ordering instructions on p. 111

6R1-BC374 \$30.99



PERFECT FIT SHIELD WALLET

Perfect Fit Bi-Fold Wallet with Credit Card Slots and ID Window

Traditional bi-fold style wallet offers ample room for currency and up to six credit cards.

- Genuine black leather
- Super double-polished, soft 18-gauge plastic reduces scratching, cracking and discoloration
- Money compartment
- Suede flap protects badge finish and ID
- Holds ID size up to 2¾" x 3½" and badge width up to 2½"

Made in the USA

6R1-BD037 \$33.49



Lightweight Windbreakers Keep Out the Cold



Plain
Black

Security
Navy/Gold



Back
Black/White

LawPro®

LawPro® Flannel Lined Windbreaker

Keep the wind out with a drawstring waist and shirred elastic cuffs.

- Nylon taffeta shell with brushed tricot lining
- Reinforced handwarmer pockets
- 6 color matching front snaps

Colors: (JC644) Black/White, Navy/Gold, Yellow/Black; (JC645) Black/White, Navy/Gold. Sizes: S-6X, see size chart A on p. 98

Description	Item	Starting at
Plain	6R1-JC382	\$22.39+
with SECURITY	6R1-JC644	\$23.33+
with POLICE [®]	6R1-JC645	\$23.33+

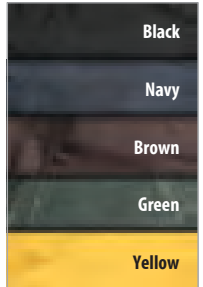

(X) Visit us online for restricted item info.



Conveniently folds into a compact pack



Lined
Black

5.11® Packable Jackets

Tight on space and your budget? This is the jacket you need. Folds into its own pocket so you can easily store and carry it with you. Your choice of unlined or fleece lined.

- Microfiber polyester
- Wind and water resistant
- Packs into hand pocket
- 2 mic tabs
- 1 vertical chest pocket and 2 hand pockets

Colors: (Unlined) all colors. (Lined) Black. Sizes: Men's (JA591) S-4X, (JA774) S-3X, see size chart D on p. 98

Description	Item	Starting at
Unlined	6R1-JA591	\$29.99+
Lined	6R1-JA774	\$49.99+

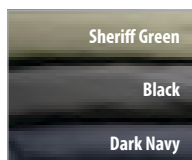

Conveniently packs into its own pocket



★ PROPPER®

PROPPER™ Packable Full Zip Lined Windshirt

Enjoy the convenient portability of this water-resistant jacket that gives you all the benefits of wind and water protection without weighing you down. Lightweight jacket packs effortlessly into its own pocket.

- 100% polyester
- Contoured, elastic hood offers additional rain repellency and visibility
- Vertical zippered pocket on chest provides safekeeping of keys or cellphone

Sizes: S-2X, see size chart A on p. 98

6R1-JX670 \$49.99

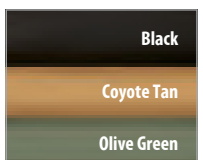

Breathable Jackets Keep Out the Rain

NEW



Men's
Collegiate



Women's
Stormy Blue



Men's
Red



Women's
Ceylon Blue



Columbia Rain Jackets

Watertight outerwear from Columbia is perfect for outdoor excursions, camping getaways and bike trips. These jackets provide serious rain protection with fully sealed seams and Columbia's proprietary Omni-Tech™ coating. This revolutionary fabric technology is applied to the inside face of fabric, which keeps the fabric from absorbing water for undaunted water-shedding action.

- Shell: Omni-Tech™ coated 100% nylon
- Lining: 100% polyester mesh
- Omni-Tech™ technology for waterproofing and breathability
- Zippered hand pockets; adjustable cuffs
- Full front zipper; attached hood
- Fully sealed seams
- Drawcord adjustable hem
- Packable into hand pocket

Colors: Men's Black, Graphite, Collegiate Navy. Women's Black, Stormy Blue. Sizes: Men's S-2X-4X, LT-4XT. Women's XS-3X, see size charts A and I on p. 98

\$59.99+

Men's Watertight II **6R1-JX826**
Women's Arcadia II **6R1-JX828**

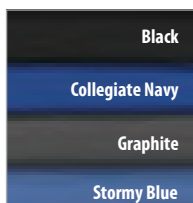

Check descriptions
for availability



Marmot® PreCip Jacket

Lightweight, packable jacket features Marmot's NanoPro™ coating technology for breathable waterproof and windproof protection. NanoPro™ microporous structure is dynamically air permeable, for air exchange without compromising water and wind protection.

- NanoPro™ nylon ripstop with taped seams
- Waterproof and breathable
- Attached adjustable hood rolls into collar
- DriClime® lined chin guard
- Adjustable VELCRO® brand cuffs
- Full-front zipper
- Elastic drawcord hem
- Angel-Wing Movement™ for full range of motion
- Underarm zips for ventilation
- Packs into its own pocket

Colors: (Men's) Black, Ink Blue, Slate Gray, Red. (Women's) Black, Ceylon Blue, Platinum, Arctic Navy. Sizes: Men's S-2X. Women's XS-2X, see size charts C and G on p. 98

\$100.00

Men's **6R1-JX319**
Women's **6R1-JX324**



Check descriptions
for availability

[+](#) Visit us online for pricing on additional options.

Ordering online? Use your **PROMOTIONAL CODE** from the back cover

800.477.7766 • galls.com

115

Water-Resistant Protection for Dry Comfort

Starting at
\$34⁹⁹



Edge Jacket
Dark Navy

Mandarin collars
can be worn
up or down

Agent LTC
Jacket
Dark Navy



Galls® Edge Jacket

The Galls Edge Jacket shields you from the elements in a lightweight nylon application.

- 100% water-resistant nylon
- 2 zippered slash pockets
- Front zipper closure
- Adjustable collars and hook-and-loop cuffs
- Side stretch panels

Sizes: S-4X, see chart A on p. 98

6R1-JX779 \$34.99

Galls® Agent LTC Jacket

This jacket protects you from the elements in a soft-shell fabric for lightweight warmth.

- 100% water-resistant polyester
- Zippered slash pockets; zippered vertical chest pocket
- Front zipper closure
- Adjustable collars and hook-and-loop cuffs
- Vented cape back
- 10" side zips with snap tab for concealed carry

Sizes: S-4X, see chart A on p. 98

6R1-JX778 \$39.99

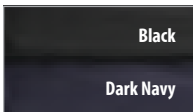

Hidden Document Pocket



Red Kap® Soft-Shell Jacket

Lightweight jacket is comfortable for casual wear and packed with features to keep you prepared for duty.

- Polyester-spandex shell with a polyester fleece lining
- Wind and water resistant
- 2 pockets with concealed zipper closures; 2 interior pockets
- Hidden document pocket with concealed zipper closure
- Full-zip front with zipper garage
- Standup collar with fleece lining

Sizes: Men's XS-4X, see size chart B on p. 98

6R1-JA251 starting at \$77.19+

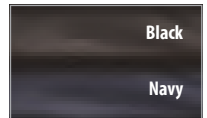

Navy

Moss



5.11® Covert Vest

Keep your firearms and gear out of sight with 5.11's Covert Vest. Design allows for quick access and ability to carry your gear in comfort.

- Polyester bonded soft-shell with mechanical stretch
- Wind and water resistant
- Hidden chest pockets with hook-and-loop closure (Backup Belt System™ compatible)
- Pass thru pocket allows quick access to IWB holster
- Two way zip with reverse coil zipper chest and hand pockets
- Internal hem counter weight pocket

Sizes: S-3X regular, see size chart D on p. 98

6R1-JC367 starting at \$84.99+



Soft-Shell Warmth with Casual Style

Navy



TRU-SPEC® 24-7 Tactical Soft-Shell Jacket

This ultra lightweight waterproof and windproof jacket has just enough stretch to work well for use with ballistic vest or holstered firearm while protecting you from the elements.

- Nylon-spandex soft-shell
- Wind and water resistant
- Ultra lightweight
- Stretchable fabric with zipper front closure and fleece lined, stand-up zip collar
- 2 angled waist pockets
- Cuffs with hook-and-loop tabs and closures
- Hemmed bottom with drawstring and cord locks

Sizes: Men's XS-5X, see chart A on p. 98

6R1-JC364 starting at \$89.95+

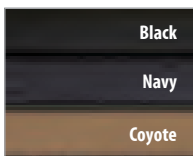

Black



NEW

★ **PROPPER™**

PROPPER™ BA Soft-Shell Jackets

Lightweight soft-shell fabric in an active, athletic cut. Chest pocket features a sleek magnet closure for silent access to warrants.

- 100% polyester on men's; 95% polyester, 5% spandex on women's
- Pocket with magnet closure on chest; zip pockets on biceps, wrists and lower back
- Pullout badge panel on left chest

Colors: Men's Navy, Black, Khaki, Olive Drab, Woodland.

Women's Black. Sizes: Men's S-4X. Women's XS-XL

\$109.99

Men's **6R1-JC471**

Women's **6R1-JX832**

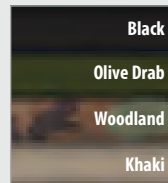

Black



TRU-SPEC® 24-7 LE Soft-Shell Short Jacket

Lightweight soft-shell jacket sits above your duty belt to provide room for ballistic vest and duty rig. Polyester exterior is treated with a finish to repel water and keep you dry on patrol.

- Polyester soft-shell with a soft brushed interior for comfort
- Wind and water resistant
- Built to stretch for comfort and mobility
- Right chest pocket, 2 sleeve pockets and 2 waist pockets for storage
- Articulated sleeve design for movement
- Adjustable hem at waist
- 6" side zips with snap tabs

Sizes: Men's S-4X, see chart A on p. 98

6R1-JA734 starting at \$99.95+

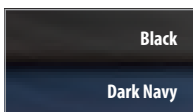

Moss/Black



5.11

5.11® Chameleon Soft-Shell Jacket

Casual style for everyday wear, or quickly identify yourself with pull down and imprintable front and back panels.

- Polyester bonded soft-shell
- Wind and water resistant
- 5 exterior pockets and 3 internal pockets for easy gear storage

Sizes: Men's S-3X, see chart D on p. 98

6R1-JA835 starting at \$119.99+

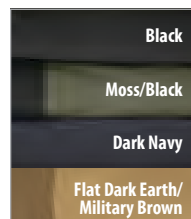

Visit us online for pricing on additional options.

Ordering online? Use your **PROMOTIONAL CODE** from the back cover

800.477.7766 • galls.com

117

Sleek, Stylish Jackets



UNDER ARMOUR®

Under Armour® Tac Jackets

- Water and wind resistant
- Dual handwarmer pockets
- Secured shoulder pocket with flag and call sign patching
- Strategic venting built into the garment at key points where the body dumps heat
- Custom UA tactical IR patch
- Loose fit

Sizes: S-3X, see size chart M on p. 99

Softshell 2.0

- Nylon, polyester and elastane soft-shell is lightweight, durable and breathable
- Dual secured hip pockets
- Helmet compatible draw cord hood

6R1-JC473 \$119.99

Gale Force

- Polyester body with a polyester-nylon upper panels
- DWR (Durable Water Repellent) finish resists water
- Easily embroidered all-weather hard face fleece jacket
- Nylon ripstop shoulder panels for durability
- Dual secured chest pockets
- Dual ear bud routing loops

6R1-JC474 \$149.99



Helmet Compatible Draw Cord Hood

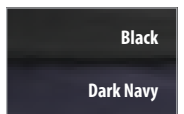

Black

Dark Navy

5.11

5.11® Sierra Soft-Shell

Tactical performance with water-resistant, soft-shell comfort.

- Polyester mechanical stretch with brushed-mesh tricot pocket lining and chin guard
- Durable water-resistant treatment protects from light rain
- RapiDraw™ pass through pockets
- Secure hook-and-loop chest pockets
- Elastic corded hem adjustments hidden inside hand pockets
- Embossed scope loop patch on upper right sleeve

Colors: Men's Black, Regatta, Battle Brown, Steam. Women's Black, Agave. Sizes: Men's S-2X. Women's S-XL, see size chart D on p. 98

\$119.99

Men's **6R1-JC635**
Women's **6R1-JC636**

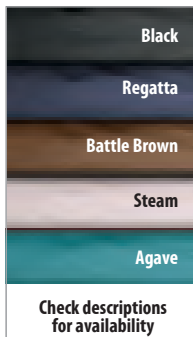

Check descriptions for availability

with Tactical Function

Black



Spiewak® Performance Soft-Shell Jacket with Side-Zips

Side-zips offer breathability and easy access to your duty rig.

- Windproof, waterproof, breathable membrane
- Tricot-lined sleeves and pockets
- Collar with fleece chin guard
- Inside storage pocket
- Back gripper waist band
- Front elasticized shock cords with keeper snaps
- Storm fly front behind zipper for added wind protection
- Epaulements with integrated mic tab

Sizes: S-5X, see size chart A on p. 98

6R1-JA167 starting at \$131.99+

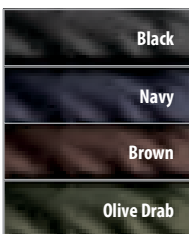

Front with Panel Down



Back with Panel Down

Dark Navy



5.11

5.11® Response Jacket

Sharp casual look for everyday wear, yet functional enough for duty.

- Lightweight microfiber polyester shell, nylon lining
- Water resistant
- 2 zippered hand pockets
- Inside chest pocket with VELCRO® brand closure
- Removable ID panels: 2 on front, 1 on back

Sizes: XS-4X, see size chart D on p. 98. **FREE** Heat press panel customization; see options starting on p. 100

6R1-JA431 starting at \$59.99+

Black



Detachable Hood

5.11

5.11® Sabre 2.0 Jacket

Full-featured, waterproof jacket is designed to allow quick sidearm access when you need it.

- Polyester bonded soft-shell
- Waterproof, including waterproof chest zippers
- Seam sealed chest pockets
- Detachable hood stored in collar or in back vertical zip pocket
- Quixip™ side zips for quick sidearm access

Sizes: XS-4X, see size chart D on p. 98

6R1-JA935 starting at \$249.99+

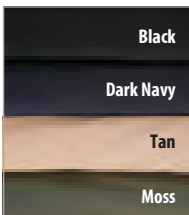

Convenient side zippers for duty belt access

Black



5.11

5.11® Fleece Jacket

Warm, soft fleece that's more rugged than conventional fleece outerwear. It comes with abrasion-resistant collar, shoulder and elbows; plus, mic tabs on each shoulder.

- Wind-resistant fleece
- Backup Belt System™ pockets; 2 zippered outside pockets; 2 zippered interior pockets
- Side zips for access to duty belt

Sizes: XS-4X, see size chart D on p. 98

6R1-JA587 starting at \$109.99+

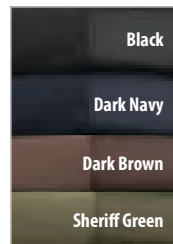

+ Visit us online for pricing on additional options.

Starting at
\$36⁷⁹

Police Bomber
Navy

LawPro®

LawPro® Classic Jackets

Fiberfill quilted liner keeps you warm in the bitter cold.

- Polyester oxford shell is durable, water resistant and wind resistant
- 2 slash welted front pockets; Police Bomber includes two-way pleated patch pockets and epaulets

Sizes: S-6X, see size chart A on p. 98

Description	Item	Starting at
Bomber	6R1-JC383	\$36.79+
Police Bomber	6R1-JA018	\$41.99+



Bomber
Navy

Black

Navy

Insulated



Brown

Removable
Insulated Liner

LawPro®

LawPro® Centurion Duty Jacket

Removable quilted liner adds warmth when needed.

- Polyester shell is wind and water resistant
- 2 hidden handwarmer pockets and inside storage pocket
- Side zips for easy access to duty gear

Sizes: S-6X, see size chart A on p. 98

6R1-JC398 starting at \$47.29+

Black

Navy

Brown

GALLS®

Galls® Three Season Jacket

With its versatility and economical price, you'll never find a better value in a jacket. Choose the classic warmth and protection of the Original model, or go with the Reflective version for added safety and visibility.

- Taslan® outer shell
- Water-resistant
- Collar and torso lined with quilted, no-pill micro-fleece
- Two zippered slash pockets
- Storm flap behind zipper placket
- Raglan sleeves quilted from shoulder to cuff
- Elastic waistband for superb fit
- YKK® zipper on front extends into collar

Sizes: S-5X, see size chart A on p. 98.

Customization: see options starting on p. 100

6R1-JA085 starting at \$47.69+



Navy/Gray

Navy/Gray

Black/Gray

Royal/Navy

Red/Gray



Gerber Enforcer SX Interchangeable Outershell Jacket

Waterproof, breathable outershell jacket with elasticized waistband to shield against the cold.

- Nylon-polyester shell is waterproof and breathable
- Two-way inverted pleat pockets with mitered flaps
- Concealable hood folds into zippered pocket under the collar
- Vented front and back yokes
- Secret Agent pull-down panels
- Side zips; mic and badge epaulets

Sizes: XS-4X Reg, L-4X Lng

6R1-JX024 \$152.29



Black



Blank
Pull-Down Panels

Black

Navy

Olive Green

Brown

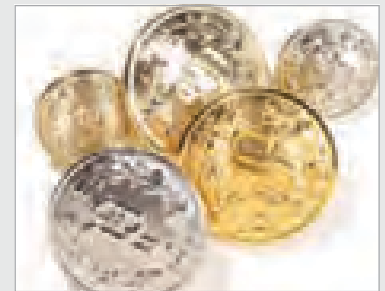

Metal Jacket Buttons

Choose "P" (Police), "S" (Security) or "FD" (Fire Dept.) sewn-on buttons.

Finishes: Gold, Silver

Description	Item	Price
P Large	6R1-UN243	\$11.99/6 pk
P Small	6R1-UN246	\$11.99/6 pk
FD Large	6R1-UN242	\$11.99/6 pk
FD Small	6R1-UN245	\$11.99/6 pk
S Large	6R1-UA317	\$20.69/6 pk
S Small	6R1-UA317	\$16.39/6 pk

(X) Visit us online for restricted item info.

Warmth Shields You from the Cold



Navy



Black



LawPro® Defender Duty Jacket

The removable liner, hood and collar give you versatile, multiseasonal protection.

- Coated polyester outer shell is both wind and water resistant
- Removable insulated liner keeps you warm
- Pleated patch pockets with handwarmer storage pockets
- Button-off pile collar provides superior warmth and comfort
- Adjustable side zips give you instant access to your weapon and equipment

Sizes: S-6X, see size chart A on p. 98

6R1-JC480 starting at \$52.49+



Zip-Out Liner

Black

Navy



LawPro® All Seasons Duty Jacket

Removable Thinsulate™ insulation provides additional warmth.

- Polyester shell is wind and water resistant
- Deluxe removable collar adds comfort and warmth
- Easy access 10" side zips with secure snap closure

Sizes: S-6X, see size chart A on p. 98

6R1-JA015 starting at \$71.39+



Removable Insulated Liner

Black

Navy



5.11® Double Water-Resistant Jacket

Keeps you dry in the rain and lets you stay cool under warmer conditions with its versatile zip-out liner.

- Nylon exterior shell
- Water-resistant fabric with zip-out liner for adjustable warmth
- Backup Belt System™ chest pockets
- Sits above the belt
- Badge tab delivered, unattached, with jacket

Sizes: S-4X, see size chart D on p. 98

6R1-JA837 starting at \$129.99+

Get your badge tabs sewn on 6R1-LA018 \$2.99



Dark Navy

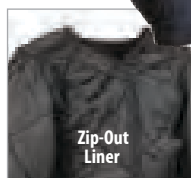

Zip-Out Liner

Black

Dark Navy



Black



Flying Cross® Waterproof Jacket

Perfect outerwear solution for fluctuating weather conditions.

- Two-ply waterproof taslanized nylon
- Black zip-out liner: Thinsulate™ lining in body and sleeves
- Six pockets; side zips with adjustable stretch tabs

Colors: Black, Brown, Forest Green, Navy. Sizes: S-5X, see size chart B on p. 98

6R1-JA843 \$133.29



Zip-Out Thinsulate® Liner

Black

Navy

Forest Green

Brown



Visit us online for pricing on additional options.

Outerwear Systems



System
Navy



Galls® 3-in-1 System

Wear the comfortable fleece alone for lightweight warmth, the outer shell for rain protection or together for maximum warmth.

Colors: (JA786) Black, Navy, (JA785) Black. Sizes: Men's S-5X, see size chart A on p. 98

6R1-JA787
starting at \$99.39+

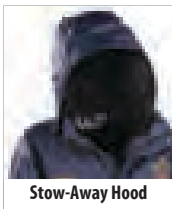

Stow-Away Hood



Jacket/Shell



Fleece/Liner

Jacket/Shell: Water-resistant nylon jacket/shell features a stowable hood, 2 hand pockets and 3 interior pockets.

6R1-JA786 starting at \$68.29+

Fleece/Liner: This quilted, polyester microfleece liner zips into the jacket/shell for extra protection from wind and rain.

6R1-JA785 starting at \$36.79+

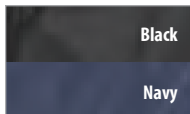

Black

Navy



Black



TRU-SPEC® H2O Proof™ Element 3-in-1 Parka

Stay comfortable despite the cold, wind and rain. Wear the shell or liner separately, or combine them for extreme protection against foul weather.

- Nylon shell is waterproof, windproof and breathable
- 2 upper chest pockets, side hand pockets and a lower back pocket
- Zipper front with VELCRO® brand storm flap
- Zip-off hood with flexible wire brim
- Full-length side zips for ventilation and weapon access



Zip-Off Hood



Black/Jacket Shell



Removable Liner

Sizes: Men's S-5X, see size chart A on p. 98

6R1-JA268 starting at \$199.95+

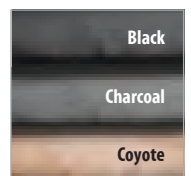

Black

Charcoal

Coyote

for Customized Warmth

Dark Navy



Black



5.11

5.11® 3-in-1 Parka

Casual styling for everyday wear. Wear the parka and shell separately or together for additional warmth.

- Shell: two-layer waterproof and breathable fabric with a nylon face
- Wind-resistant fleece liner
- Shell has 11 pockets, including Backup Belt System™ chest pockets
- Liner has 4 pockets
- Removable, front and back pull-down panels with **FREE** personalization
- Sew-on badge holder

Sizes: S-4X, see size chart D on p. 98

6R1-JA331
starting at
\$249.99+



Stow-Away Hood



Convenient side zippers for duty belt access



Black Jacket/Shell



Black Fleece Jacket/Liner

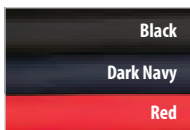

5.11

5.11® Bristol 3-in-1 Jacket

The Bristol Jacket allows you to patrol in winter weather with plenty of tactical features and side-zip pockets.

- Nylon body and polyester lining
- Waterproof and breathable
- Seam-sealed construction
- Removable, wearable soft-shell liner
- Pullout ID panels
- Quixip™ side zips for quick access to sidearms

Sizes: XS-4X, see size chart D on p. 98

6R1-JA182 starting at **\$289.99+**

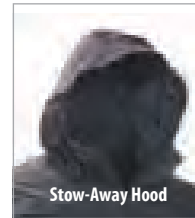

Stow-Away Hood



Black Jacket/Shell



Removable Soft-Shell Liner

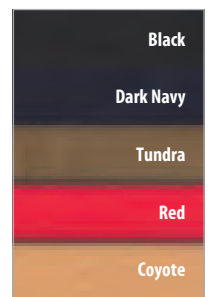

No Hassle Guarantee

See p. 98



Visit us online for pricing on additional options.

Ordering online? Use your **PROMOTIONAL CODE** from the back cover

800.477.7766 • galls.com

123



Duty and Soft-Shell Jacket
Black

5.11

5.11® Valiant 5-in-1 Duty Jacket

Traditional duty jacket design includes a soft-shell jacket (JA186, see below). Also includes a sleeve zip-off option to easily adapt to changing environments.

- Nylon body with polyester lining
- Waterproof and breathable
- Seam sealed
- Hidden document pockets
- Pullout ID panels
- Quixip™ side zips for quick access to sidearms

Sizes: XS-4X, see size chart D on p. 98

6R1-JA185 starting at \$289.99+



Quixip™ side zips for access to sidearms



Black Jacket/Shell



Wear the jackets with sleeves...



... or without sleeves as a vest

5.11® Valiant Soft-Shell Jacket

Lightweight polyester is ideal for patrol with ventilation and removable sleeves. Zips into Valiant Duty Jacket for extra warmth.

- Polyester construction
- Tricot backed chin guard to protect from abrasion
- Zipper garage for water resistance
- Hand pockets and chest pocket
- Side zips for ventilation

Sizes: XS-4X, see size chart D on p. 98

6R1-JA186 starting at \$129.99+



Side zips for ventilated comfort

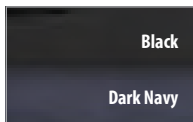

Black

Dark Navy

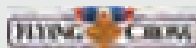

LayerTech Outerwear from Flying Cross®

For a flexible outerwear system that adjusts to any environment, there is the LayerTech system from Flying Cross. Components work seamlessly together, providing you with a year-round garment that transitions smoothly in fluctuating climates. Layers can be easily added or subtracted for the ultimate in multi-weather defense.

LAPD Navy



POLICE

Back with optional panel down

POLICE

Front with optional panels down

Black/Yellow



 Visit us online for pricing on additional options.

Adaptable Outerwear from Flying Cross®



Flying Cross® LayerTech All Season Jacket

Prepare for every type of weather in this All-Season Jacket, featuring GORE-TEX® breathable technology for protection against wind and rain.

- 100% nylon
- Zip-In compatible with the LayerTech Thinsulate Liner, Soft-Shell and Performance Loft Jackets
- GORE-TEX® lined hood
- Pockets: 2 inverted pleated pockets with mitered flaps and snap closure, left pocket pencil opening and handwarmer pockets, vertical utility pockets on each storm flap, right and left inside storage
- Articulated set-in sleeve
- Front storm flap with two-way zipper
- High speed utility straps
- 10" side zips with elastic tab adjustment and windproof zipper flaps
- Permanent badge tab and unattached mic tab
- Interchangeable zipper

Sizes: Men's XS-S Reg, Short; M Reg, Short, Lng; LG-4X Reg, Short, Lng, XLng; 5X-6X Reg, Lng. See size chart D on p. 98.

FREE Heat press panel customization. See options starting on p. 100

6R1-JX764 starting at \$289.99+

Optional ID Panels in Black or Navy **6R1-JA632 \$39.99/3 pk**



Side zips for ventilated comfort

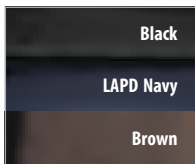

Flying Cross® LayerTech ANSI II Certified Reversible Jacket

In the event of stormy conditions, you can stay warm and dry with the wind and waterproof three-ply nylon. Supplex™ nylon is particularly breathable, stretchable and fast drying, so you can enjoy a comfortable level of warmth without needless, suffocating bulk.

- ANSI/ISEA 107-2004 third party certified
- 100% three-ply Supplex™ nylon; wind and waterproof
- 2 rows of 2" wide 3M™ Scotchlite™ reflective tape
- Dual-entry inverted pleat patch pockets
- Articulated sleeves
- Cross-stitched shoulder straps
- 2 10" side zips with elasticized snap tabs
- Interchangeable zipper
- Permanent badge tabs



Reversible Jacket

Sizes: Men's XS-S Reg, Short; M Reg, Short, Lng; LG-4X Reg, Short, Lng, XLng; 5X-6X Reg, Lng. See size chart A on p. 98

6R1-JX765 starting at \$189.99+



Flying Cross® LayerTech Soft-Shell Jacket/Liner

This stylish jacket is professional enough for on-the-job and comfortable enough for everyday wear. Short enough to ride above your duty belt, the Soft-Shell can be worn stand alone or zipped into the All Season or Hi-Vis Reversible Jackets.

- 88% polyester, 12% spandex® shell two-way stretch fabric
- 2 lower and 2 upper storage pockets
- Articulated set-in sleeve for complete mobility
- Comfort stretch cuff for easy adjustments
- 10" side zips with elasticized snap tabs
- Unattached badge tab

Men's Sizes: XS-4X, see size chart D on p. 98

6R1-JA820 starting at \$138.79+

Dark Navy

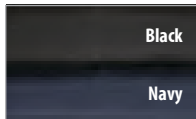

Flying Cross® LayerTech 37.5™ Performance Loft Jacket/Liner

The Performance Loft Jacket is the ultimate in lightweight comfort and features 37.5™ active particle technology to help regulate your body's temperature in cold weather. Wear stand alone or zipped into the All Season or Hi-Vis Reversible Jackets.

- 100% 50 denier polyester
- 37.5™ natural technology enhances cooling, adds UV protection and offers increased odor protection
- Wind resistant, waterproof and breathable
- Snap on hood
- Side entry pockets plus right sleeve pocket with zipper closure; chest pockets with storm flaps
- Side zips for underarm ventilation
- Interchangeable zipper

Sizes: Men's XS-S Reg, Short; M Reg, Short, Lng; LG-4X Reg, Short, Lng, XLng; 5X-6X Reg, Lng. See size chart D on p. 98

6R1-JX762 starting at \$159.99+

Navy

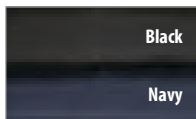

Flying Cross® LayerTech Thinsulate™ Zip-In Liner

Enjoy the option of zipping in this liner on chilly mornings and zipping out when the temperature rises.

- 100% polyester
- Water resistant; interchangeable zipper

Black. Sizes: Men's XS-S Reg, Short; M Reg, Short, Lng; LG-4X Reg, Short, Lng, XLng; 5X-6X Reg, Lng. See size chart D on p. 98

6R1-JX763 starting at \$49.99+

Black



(sold as a liner only)

Flexible Outerwear for Unpredictable Weather



Performance
Soft-Shell Jacket &
Hi-Visibility Parka Kit

3M



Elbeco™ Shield Kits

For flexible outerwear that will see you through all the seasons, the Shield System from Elbeco is your multi-defense solution. Individual components can be worn together or separately for the ultimate in versatility. Wear the parka or duty jacket by itself or add a layer of warmth with the soft-shell. Interchangeable options make it possible for you to buy only what you need and to enjoy the level of weather protection you need for patrol.

Duty Jacket Kits \$305.19 SAVE \$28.19

w/Performance Soft-Shell **6R1-JX203**

w/Apex Soft-Shell **6R1-JX201**

\$333.38 if purchased separately

Hi-Visibility Parka Kits \$326.99 SAVE \$44.39

w/Performance Soft-Shell **6R1-JX202**

w/Apex Soft-Shell **6R1-JX200**

\$371.38 if purchased separately



Elbeco™ Shield Kit Components

Versatile pieces can be worn by themselves or together for customized comfort and functionality. Layers keep you warm, dry and protected in vacillating climates.

- HydroTech membrane is windproof, waterproof and breathable
- Handwarmer pockets; dual utility pockets
- Magnetic closures on pockets (except for JX012)
- Multiple storage options for communications or concealed carry
- Lined collar with chin protector (except for JX009)
- Shoulder straps with mic clip tunnel

Sizes: Men's S-4X, see size chart A on p. 98

Hi-Visibility Parka

- Meets ANSI 107-2010 Class III
- High performance polyester oxford shell
- 3M™ reflective striping around sleeves, waist and bottom
- Three-piece internally stored hood with drawstring
- Articulated elbows and adjustable cuffs

Hi-Vis Yellow

6R1-JX010 \$245.99



Duty Jacket

- Polyester ripstop shell for lightweight durability
- Three-piece internally stored hood
- I.D. panels with hook-and-loop above front pockets and across the back

6R1-JX009 \$207.99



Black

Black

Midnight Navy

Performance Soft-Shell Jacket

- Polyester and spandex exterior with fleece interior
- Adjustable hook-and-loop cuffs with elastic
- Side vents with Quick Release zipper closure

6R1-JX012 \$125.39



Black

Black

Midnight Navy

Apex Soft-Shell Jacket

- Polyester knit exterior with two-way stretch and fleece interior
- Polyester mini ripstop fabric overlay on shoulder, yoke and elbows for durability
- Adjustable hook-and-loop cuffs with elastic

6R1-JX011 \$125.39



Black

Black

Midnight Navy

Hi-Viz Jackets for Low-Light Conditions

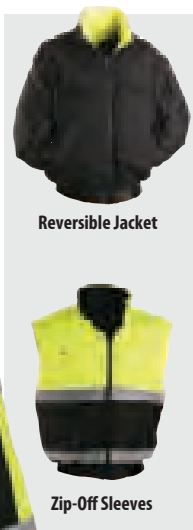

Reversible Jacket

Zip-Off Sleeves



Black/Yellow



Reversible Jacket

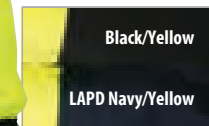

Black/Yellow

LAPD Navy/Yellow



TSA ANSI Class III Two-Tone Reversible Jacket

This jacket's sleeves and roll-away hood are both removable, allowing you to customize your protection.

- Shell meets ANSI 107-2010 Class III standards
- Waterproof polyurethane-coated, polyester-oxford shell with reflective tape reverses to quilted twill
- Side slash pockets on twill side
- ID, chest, cargo and handwarmer pockets on reflective side
- Rib knit cuffs and waistband
- Heavy-duty zipper closure

Lime Green/Black. Sizes: Men's S-5X, see size chart A on p. 98

6R1-JA961 \$70.99



5.11® Reversible High-Vis Duty Jacket

When you need to go from visible to covert, this reversible duty jacket gives you the flexibility you need. Wear the reflective side and be easily seen when working in hazardous environments, or flip to solid color to blend naturally with the crowd when on patrol work.

- Water-resistant fabric reverses to ANSI Class II, Level 2/ISEA 107-2010
- Highly visible nylon exterior shell
- 3M™ Scotchlite™ reflective tape
- Backup Belt System™ chest pockets
- Above the belt length for easy access to duty belt
- Badge tab delivered, unattached, with jacket

Sizes: Men's S-4X, see size chart D on p. 98

6R1-JA836 starting at \$129.99+



Visit us online for pricing on additional options.



Gerber Thriller SX 5-in-1 Jacket with Warrior Soft-Shell

Reversible, waterproof and breathable system jacket.

- Meets ANSI 107 Class III certification
- Nylon-polyester outershell and Warrior soft-shell liner can be worn separately or together
- Handwarmer pockets, box pleat pockets with scalloped flaps, triple belled inset cargo pockets
- Drop-in, tri-panel hood with storm closure

Sizes: XS-4X Reg, L-4X Lng

6R1-JA775 \$172.59



Roll-Away Hood



Reverses to duty jacket

Zip-out liner can be worn alone

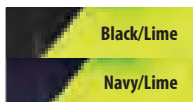

Black/Lime

Navy/Lime

Black/Lime



Waterproof, Seam-Sealed, Breathable



3-in-1
Black/Fluorescent
Yellow



Reversible Parka



Parka with 3M[™]
Scotchlite[™] Tape



Fleece Liner



Stow-Away Hood

5.11 3M

5.11[®] ANSI Class III 3-in-1 Reversible System

Warmth, high visibility and versatility.

- ANSI/ISEA 107-2004 Class III compliant
- Nylon shell
- 3M[™] Scotchlite[™] reflective tape
- Waterproof, seam-sealed, breathable laminate
- 6 pockets: 2 chest, 2 handwarmer and 2 inside chest
- Mic loops, badge tab and side zips
- Includes black fleece liner that can be worn alone

Fluorescent Yellow/Black. Sizes: Men's S-4X, see size chart D on p. 98

6R1-JA514 starting at \$249.99+

Parka **6R1-JA429 starting at \$159.99+**



ANSI Class III Hi-Vis
Royal Blue



First Responder



Soft-Shell Liner



Removable Sleeves

5.11 3M

5.11[®] First Responder Jackets

Designed specifically for the first responder who is first on the scene and last to leave. The First Responder is a fully seam-sealed, waterproof, breathable jacket. Lined with bloodborne pathogen-resistant properties, this garment creates a reliable barrier between you and infectious microorganisms. A removable soft-shell liner that can be worn separately gives you multi-weather defense for fluctuating temperatures.



Hood can be removed or stowed away

- Soft-shell liner with removable sleeves
- Waterproof, seam-sealed, breathable
- Bloodborne pathogen resistant
- Removable hood
- Storm flaps; adjustable cuffs
- Full-length underarm Quixip[®] side zips for sidearm access

Colors: (JX769) Black, Dark Navy; (JX770) Dark Navy, Range Red, Royal Blue. Sizes: S-4X, see size chart D on p. 98

6R1-JX769 \$344.99+

ANSI Class II Hi-Vis: Meets ANSI/ISEA 107-2010 Class III standards

6R1-JX770 \$344.99+



ANSI Class III Hi-Vis

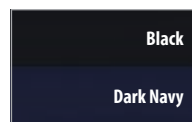

First Responder

[+ Visit us online for pricing on additional options.](#)

Reversible ANSI III Compliant Rainwear



VizGuard® Reversible Duty Raincoats

Lightweight single ply nylon P/U coated for comfort, ANSI Class III for visibility.

- Third party certified compliance with ANSI 107-2004 Class III
- Complies with FHWA required Rule 23 CFR Part 634 of the Federal Registry
- Black nylon oxford shell with fluorescent Viz-Tech® coating on reverse side
- 3M™ Scotchlite™ reflective material
- Waterproof with sealed seams
- Snap-on reversible hood with drawcord
- Full-length double placket with heavy-duty front snap closure
- Badge tabs on both sides

Yellow/Black. Sizes: see size chart B on p. 98

31": Snap closure side vents

for equipment access.
Sizes: Men's S-6X

6R1-RW122 starting at \$134.99+

48": Hook-and-loop closure pass thru for inner access.

Sizes: Men's XS-4X

6R1-RW121 starting at \$149.99+



Coat



5.11®

5.11® Long Reversible Hi-Vis Rain Coat

Reverse from black to hi-vis to go from professional to visible, or snap off bottom to change from long to parka-length raincoat.

- Reverses to ANSI/ISEA 107-2010 Class III
- Double nylon oxford layer reverses to polyester hi-vis yellow
- Waterproof, seam sealed construction
- Snap front
- Lower portion of coat snaps off to parka length
- Pass thru pocket access
- Mic loops and badge tabs on both sides

Yellow/Black. Sizes: Men's S-3X, see size chart D on p. 98

6R1-RW169 starting at \$139.99+



Snap off bottom to convert from long to short coat



Reverses to black



Gerber Typhoon Reversible Rainwear

Water and wind protection with breathable coverage. Reverses from black to yellow with an ANSI Class III rating. Scotchlite™ reflective striping on the yellow side for additional visibility.



Reverses to black

- ANSI 107 Class III rating with Scotchlite™ reflective striping
- 50% nylon, 50% polyester
- Waterproof, breathable and windproof
- Hand pockets on both interior and exterior sides
- Drop-in concealable hood
- Double storm flap front with reversible zipper closure
- Extended hip length for additional coverage
- YKK® side zips
- Mic and badge tabs

Black/Lime reversible. Sizes: XS-4X Reg, L-4X Lng

Description	Item	Price
Jacket	6R1-RW315	\$141.99
Coat	6R1-RW316	\$152.29

Raise Your Level of Visibility

NEW



Maximum Visibility

Neese Reversible Jackets provide rain protection with 360 degrees of visibility to satisfy both ANSI and ISEA standards. The ANSI/ISEA Class III combination translates into the highest level of visibility, even in harsh weather conditions with traffic exceeding 50 mph. The Class E certified pants, when worn with a Class III jacket, automatically convert to a Class III ensemble.



Neese Reversible Weatherproof Rainwear

Reversible rainwear from Neese is perfect for outdoor patrol shifts and camping getaways.

- 45% polyester, 40% nylon, 15% polyurethane with tri-laminated tricot
- Silver reflective tape trimmed in black on hi vis side
- Waterproof, windproof, breathable
- Slash-through openings with hook-and-loop closure

Black/Hi Vis. Sizes: S-6X, see chart B on p. 98

Jackets: ANSI/ISEA 107-2010 Class III Certified. Snap front with inner and outer storm flaps. Detachable hood. Raglan shoulder design for ease of movement, with a badge patch on both sides.

Pants: ANSI/ISEA 107-2010 Class E Certified. When worn with a Class III jacket, the outfit automatically converts to a Class III ensemble.

Description	Item	Price
32" Jacket	6R1-JK021	\$124.99+
48" Jacket	6R1-JK020	\$159.99+
Pants	6R1-TJ137	\$69.99+

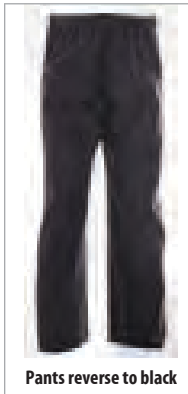

Pants reverse to black

System starting at
\$147¹⁹



VEA® ANSI Class III Waterproof System

The ANSI 107-2010 Class III system includes a waterproof parka and jacket, with the flexibility of wearing the parka or jacket alone to accommodate the changing weather.

Lime Green. Sizes: Men's S-5X, see size chart A on p. 98

6R1-JA534 starting at \$147.19+

Starting at \$165.48+ if purchased separately **SAVE \$18.29**



Jacket zips into parka for a complete waterproof system

+ Visit us online for pricing on additional options.

... Or Purchase the Pieces Separately

Parka: Mesh lined with reflective tape for increased visibility.

- Mesh lining
- 3M™ Scotchlite™ reflective tape
- Cell phone pocket
- Hood stores in collar; zipper extends through collar; radio tab

Sizes: Men's S-5X, see size chart A on p. 98

6R1-JA533 starting at \$87.29+



Jacket: Perfect to wear alone or with system parka.

- ANSI 107-2010 Class III compliant
- Polyester shell
- Water-resistant
- Cell phone pocket
- Fleece-lined collar and torso; zipper extends through collar
- Knit cuffs and waistband

Sizes: Men's S-5X, see size chart A on p. 98

6R1-JA006 starting at \$78.19+



with ANSI Compliant Rainwear



VEA® ANSI Class E Waterproof Breathable Two-Tone Rain Pants

Waist features both elastic and drawstring for maximum adjustment and comfortable fit.

- Two-tone fabric from the calf down
- 2 snap pass-through pockets
- Hem offers metal snaps to adjust at ankles

Fluorescent Lime/Black. Sizes: Men's M-3X, see size chart A on p. 98

6R1-RW136 starting at \$44.59+



SPIEWAK®
since 1964

Spiewak® Hi-Vis Soft-Shell

Waterproof, breathable membrane to keep you dry, cool and comfortable. Clean uniform appearance.

- ANSI 107-2010 Class 2
- Windproof shell
- Waterproof, breathable
- Zip-off sleeves
- Power hook-and-loop closure on elastic cuff protection
- Front elasticized shock cords with keeper snaps
- Back gripper waistband
- Epaulets with mic holder

Yellow/Black. Sizes: Men's S-4X, see size chart B on p. 98

6R1-JA934 \$142.99



Zip-Off Sleeves

VISIT US ONLINE ▼

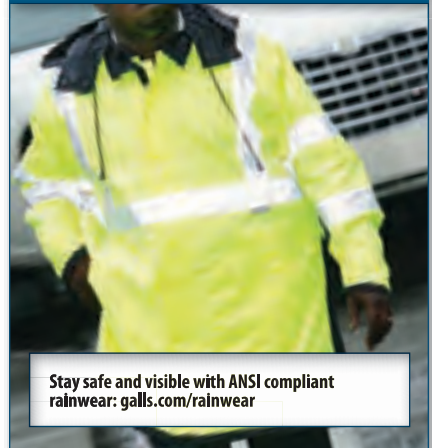

Stay safe and visible with ANSI compliant rainwear: galls.com/rainwear

Reflective Rainwear for Outdoor Patrol



48"
Lime Green
with Titles

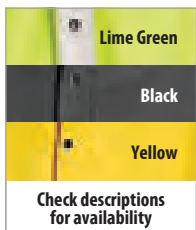

Check descriptions
for availability



Neese Rainwear PVC Vinyl Rain Jacket and Raincoat

Excellent value in reflective outerwear.

- Waterproof with sealed seams
- Detachable, snap-on hood
- Snap front and sleeve closure
- Ventilated back and underarms

Colors: (Jacket) Lime Green, Yellow. (Raincoat) Lime Green, Black, Yellow. Custom Titles: No minimum order! Setup fee of just \$85. Number of lines and allowable lettering can vary. Call for details.

30" Rain Jacket: Sizes: Men's M-2X, see size chart B on p. 98

Lime Green 30" Rain Jacket: 6R1-RW092
Plain starting at **\$23.29+**
With Titles starting at **\$28.29+**

Yellow 30" Rain Jacket: 6R1-RW039
Plain* starting at **\$9.69+**
With Titles starting at **\$15.99+**

Lime Green 48" Raincoat: Titles: CROSSING GUARD not available in Black. Sizes: Men's M-4X.

6R1-RW093
Plain starting at **\$27.99+**
With Titles starting at **\$34.19+**

Black or Yellow 48" Raincoat: Titles: See below. Sizes: Men's S-6X, see below.

6R1-RW032
Plain starting at **\$11.49+**
With Titles starting at **\$17.69+**

Colors	Sizes	Titles
Black	S, 6X	Corrections, Plain, Security
Black	M, L-2X, 4X	Corrections, Plain, Police, Security, Sheriff
Black	3X	Corrections, Crossing Guard, Plain, Police, Security, Sheriff
Black	5X	Corrections, Plain, Police, Security
Yellow	S	Corrections, Crossing Guard, Plain, Police, Security, Sheriff
Yellow	M-4X	Corrections, Crossing Guard, Emergency Services, Fire Department, Fire Rescue, Plain, Police, Security, Sheriff
Yellow	5X, 6X	Corrections, Plain, Police, Security, Sheriff

(X) Visit us online for restricted item info.



Starting at
\$9⁴⁹

Hi-vis reflective striping
on front and back
of lime green
jackets and
coats



48"
Black

Choose
screenprinted title or
plain (no lettering)
for jacket and coat

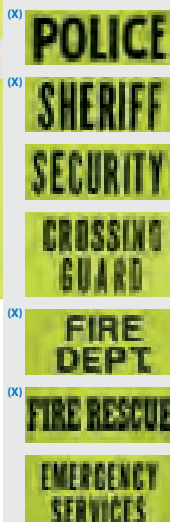

Check descriptions
for availability



Reverses to black

LawPro®

LawPro® Reversible 48" Deluxe Raincoat

Reflective striping across back and cuffs on Hi-Vis side so you are seen more easily in heavy traffic.

- Lightweight nylon polyvinyl
- Waterproof with sealed seams
- Reflective elements
- Slash through pockets for easy access to duty belt
- Snap front closure with storm flap

Hi-Vis Yellow/Black. Sizes: Men's S-6X, see size chart D on p. 98

6R1-RW217 starting at \$47.49+

+ Visit us online for pricing on additional options.

Knuckle Guard Protection



Damascus® Unlined Hybrid Duty Gloves

An all-purpose, year-round duty glove with low profile, hard knuckle zones for increased protection.

- Palms of Synthetic Suede, lightweight Spandura nylon backs for breathability and easy cleaning
- Reinforced palm panels for extra durability
- Pull tab for easy on and off
- Hook-and-loop wrist closure

Black. Sizes: S-2X, see size chart O on p. 145

6R1-GL432 \$22.29



Galls® Elite SWAT Gloves

Dual-layer reinforced leather palms and fingertips for rappelling. Spandex mesh for increased airflow.

- Carbon Tek® hard knuckles for forced door entry and knuckle protection
- Adjustable wrist closures

Black. Sizes: S-2X, see size chart O on p. 99

6R1-GL389 \$40.49



NEW

Hatch Reactor Hard Knuckle Gloves

Leather-covered hard knuckles for excellent protection.

- Durable goatskin construction with water-resistant leather treatment
- Light foam padding at base of fingers and high-density foam in meaty portion of palm for shock absorption
- PVC non-slip on the tips of the index and middle finger for grip and dexterity

Sizes: XXS-3X, see size chart P on p. 99

6R1-ZY020 \$40.59



TACTICAL & DUTY DESIGNS

HWI Gear Hard Knuckle Tactical Gloves

Impact-resistant hard knuckle is combined with cut and fire-resistant DuPont™ Kevlar®.

- High-grade goatskin leather palm with digital leather reinforcement
- DuPont™ Kevlar® on back of hand provides fire and cut resistance
- Injection-molded hard knuckle
- Hook-and-loop closure for secure fit
- Wrapped trigger finger design
- Ergonomic contour cut

Sizes: XXS-3X, see size chart P on p. 99

6R1-GL732 \$46.99



Black

Black

Sage

Tan



Under Armour® TAC Duty Gloves

Protect your hands with warmth and comfort.

- Sheepskin leather, synthetic leather, silicone, neoprene and polyester
- Padded knuckle protection
- Strategically placed silicone grip
- Reinforced palm strength
- Access touchscreen devices with conductive thread

Sizes: S-XL, see size chart O on p. 99

6R1-GL090 \$49.99

Coyote



Black

Coyote



Oakley® SI Assault Gloves

Flexible four-way stretch with Airprene joint panels.

- Durability and comfort of Pittards® full-grain leather palm with micro venting
- Comfortable breathability of mesh zones and rubber exhaust ports
- Shielding of carbon fiber knuckle plating
- Secure grip of Unobtanium® on fingers
- Nonrestrictive Airprene mid-height cuff with secure VELCRO® brand closure

Sizes: XS-2X, see size chart P on p. 99

6R1-GL025 \$70.00

Black



Black

Forest Green

Coyote Tan

Khaki

Cut-Resistant Protection with KEVLAR®



LawPro®

LawPro® Neoprene Uniform Gloves with KEVLAR®

DuPont™ KEVLAR® fiber provides cut and flame-resistant protection.

- Synthetic leather palm allows maximum sensitivity
- Breathable neoprene back provides comfort
- Non-slip materials on all fingertips except trigger finger

Black. Sizes: S-2X, see size chart O on p. 99

6R1-GL631 \$29.39

\$29³⁹



Damascus® Frisker K Leather Gloves with KEVLAR®

Combines the durability of leather with DuPont™ KEVLAR® fiber cut-resistant lining.

- Smooth premium quality cowhide
- DuPont™ KEVLAR®
- Water resistant

Black. Sizes: S-2X, see size chart O on p. 99

6R1-GL214 \$31.69



LawPro®

LawPro® SlashGuard Duty Gloves

Non-slip material in hand cradle offers sure grip for better weapon control.

- DuPont™ KEVLAR® fiber bonded to Clarino® synthetic leather
- Cut and flame resistant
- Thin neoprene and nylon spandex back for a snug fit
- Terry cloth outer thumb used as a perspiration wipe

Black. Sizes: S-2X, see size chart O on p. 99

6R1-GL682 \$31.99



Damascus Enforcer Gloves

The fit, style and features of Neoprene gloves with the cut protection of DuPont™ KEVLAR®.

- Neoprene, synthetic leather w/ DuPont™ KEVLAR® liner
- Breathable synthetic outer shell
- Provides cut protection against razors, glass, knives and other sharp edges
- High level of grip and trigger control

Black. Sizes: S-2X, see size chart O on p. 99

6R1-GL199 \$33.19



GALLS®

Galls® Neoprene Gloves with KEVLAR®

Cut protection plus a comfortable fit.

- Neoprene material to keep hands warm and dry
- Textured synthetic leather patches on palm and fingertips for better grip
- KEVLAR® lining to protect hands from cuts
- VELCRO® brand closures for better fit and additional comfort

Black. Sizes: S-2X, see size chart O on p. 99

6R1-GL387 \$34.99



Hatch® Streetguard KEVLAR® Gloves

Synthetic leather palms with DuPont™ KEVLAR® fiber lining.

- NIJ tested CE EN 338: 1994
- Neoprene and spandex back for air circulation
- Extreme Grip™ non-slip material in palm for grip
- Hook-and-loop wrist closure

Black. Sizes: XS-6X, see size chart P on p. 99

6R1-GL179 \$37.49



Hatch® Resister Gloves

Keep your hands dry while protecting them from accidental cuts and slashes.

- Water and fade-resistant premium leather
- 100% KEVLAR® knit liners for moderate cut resistance
- Wrist-length elasticized cuff

Black. Sizes: S-2X, see size chart P on p. 99

6R1-GL065 \$40.59



Cut-Resistant Protection with Spectra®



Damascus® Frisker S Leather Gloves with Spectra

Honeywell® Spectra® provides greater protection at an affordable price.

- Smooth cowhide with Spectra® lining
- Spectra® lining has twice the cut resistance of DuPont™ KEVLAR® fiber
- Water resistant
- Extended gathered wrists

Black. Sizes: S-2X, see size chart O on p. 99

6R1-GL215 \$34.99



HWI Gear Level V Gloves

Provides the highest possible cut-resistant protection under EN388 testing standards.

- EN388 Level V cut-resistant liner
- Spectra® lining
- Laminated spandex knit and neoprene back for comfort and flexibility
- Synthetic leather palm for performance and abrasion resistance
- Hook-and-loop closure for secure fit

Sizes: S-3X, see size chart P on p. 99

6R1-GL734 \$38.99

Puncture-Resistant Protection



HexArmor® High Performance Search and Duty Gloves

Provides high cut-resistant (ISEA Level V) and needlestick protection on fingertips and part of the palm.

- SuperFabric® material with a double layer on fingertips
- AirMesh™ breathable back

Black. Sizes: S-2X, see size chart P on p. 99

6R1-GL380 \$47.49



TurtleSkin® Duty Gloves

Provides strong protection against hypodermic needles and cuts.

- Puncture resistant to 267 grams of force
- Cut resistant to 1458 grams of force
- Snug knit backing

Black. Sizes: S-2X, see size chart O on p. 99

6R1-GL207 \$53.29



TurtleSkin® ALPHA Gloves

Excellent cut and puncture protection on the palm, as well as a high level of slash resistance on the back of the hand.

- Cut and puncture resistant
- Protects against 28 gauge needlesticks
- Grip pads for uncompromised dexterity

Black. Sizes: S-2X, see size chart O on p. 99

6R1-GL585 \$60.79

Lightweight Gloves



NEW

Black

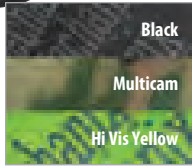

Mechanix Wear® Fastfit Covert Gloves

Form-fitting with TrekDry® technology to keep your hands cool and comfortable, these gloves are lightweight and breathable. Developed for field-friendly flexibility, these easy on/off gloves are the perfect pair for tactical tasks. Ideal for military and law enforcement units, shooting sports and maintenance repair operations.

- Synthetic leather
- Durable synthetic palm
- Form-fitting TrekDry® material for cool comfort
- Reinforced thumb and index finger for added durability
- Anatomically designed two-piece palm to eliminate material bunching
- Elastic cuff for a secure fit and easy on/off
- Fabric loop for glove storage
- Machine washable

Sizes: S-2X, see size chart O on p. 99

6R1-GL771 \$15.95



NEW

Covert

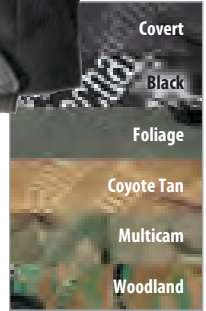

Mechanix Wear® Original Glove

The Original® glove revolutionized the hand protection industry with its versatile design. Durable microfiber extends the life of the glove and breathable TrekDry® forms to the back of the hand, creating an exceptional fit with superior dexterity.

- Form-fitting TrekDry® keep hands cool and comfortable
- Seamless single layer palm improves fit and dexterity
- Thermal Plastic Rubber (TPR) hook-and-loop closure
- Nylon loop provides convenient glove storage
- Machine washable

Sizes: S-2X, see size chart O on p. 99

6R1-GL239 \$24.99



Damascus® Viper Duty Gloves

Damascus® Viper™ Duty Gloves provide superb sensitivity and control.

- AirMesh™ breathable backs
- Thin-cut premium sheepskin leather with laser-etched Spyder™ print provides maximum sensitivity
- Seamless rolled finger tip for superior tactility
- Water and oil-resistant
- Neoprene wrists and back panels for flexibility

Black. Sizes: S-2X, see size chart O on p. 99

6R1-GL378 \$32.69



NEW

Black



Mechanix Wear® M-Pact Gloves

Impact-absorbing Thermal Plastic Rubber (TPR) is sonic welded to the glove and delivers flexible protection against common impact injuries and skin abrasions.

- Impact Guard™ protects first knuckle with EVA foam padding
- Form-fitting TrekDry® material
- XRD® palm padding absorbs impact
- TPR knuckle guard and finger guards
- Durable microfiber palm
- Armortex® palm reinforcement panel
- Dual-layer fingertip reinforcement
- Embossed, textured index finger and thumb provides grip
- Nylon loop with bartack stitch
- TPR hook-and-loop closure
- Machine washable

Sizes: S-2X, see size chart O on p. 99

6R1-GL557 \$34.95



Hatch® CoolTac Summer Weight Duty Gloves

Lightweight gloves are ideal for warmer climates.

- Palm is constructed of .5mm hair-sheep leather for dexterity
- Protection for handling suspects and for touching hot metal objects
- Excellent breathability and comfort
- Signature ergonomic cut

Black. Sizes: S-2X, see size chart P on p. 99

6R1-GL529 \$35.59



5.11® TacLite 2 Lightweight Second-Skin Gloves

Ultra-light gloves redefine comfort with their thin, breathable and fast-drying material that feels like a second layer of skin.

- Four-way stretch breathable nylon and spandex back panel
- Seamless Hair Sheep palm for unsurpassed dexterity and comfort
- Tactical Touch™ precision fit fingertips for maximum dexterity and comfort

Black. Sizes: S-2X, see size chart O on p. 99

6R1-GL404 \$33.19



with Exceptional Dexterity



\$15⁷⁹

LawPro®

LawPro® Neoprene Uniform Gloves

Conforms to your hands, providing exceptional dexterity all the way to the fingertips.

- Made of water-resistant neoprene and strong yet supple synthetic leather
- Reinforced elastic wristband with adjustable strap

Black. Sizes: S-XL, see size chart O on p. 99

6R1-GL009 \$15.99



Damascus® Lightweight Patrol Gloves

Lightweight protection provides almost as much feel and control as your bare hands.

- Palms made of premium single-layer leather with perforated air vents
- Lightweight Lycra® twill backs provide additional stretch and extra breathability
- Zero bulk for lightweight, controllable feel
- Elasticized wrist opening

Black. Sizes: S-2X, see size chart O on p. 99

6R1-GL429 \$15.99



LawPro®

LawPro® Unlined Leather Search Gloves

Soft cowhide leather provides durability with dexterity.

- Treated water-resistant leather outer shell
- Elasticized cuff for a snug and secure fit

Black. Sizes: S-2X, see size chart O on p. 99

6R1-GL632 \$19.19



LawPro®

LawPro® Lightweight Multipurpose Duty Gloves

Clarino® synthetic palm provides durability with dexterity.

- Lightweight nylon and Lycra® blend for year-round use
- Nonslip grip patches on palms and fingertips

Black. Sizes: S-2X, see size chart O on p. 99

6R1-GL681 \$21.39



HWI
TACTICAL & DUTY DESIGNS

NEW

HWI Gear Unlined Duty Gloves

Ergonomic design and wrapped trigger finger provide greater control.

- Moisture-wicking spandex knit on back of hand for breathability and abrasion resistance
- Genuine goatskin leather palm
- Wrapped trigger finger; contour cut
- Hook-and-loop closure

Black. Sizes: S-2X, see size chart O on p. 99

6R1-GL737 \$24.99



5.11

5.11® TAC-A2 General Tactical Application Gloves

Tactical Touch™ precision fit fingertips offer maximum dexterity and comfort.

- Breathable, stretch nylon back panel
- Synthetic suede palm
- Synthetic leather grip pads
- Lightweight and fast drying
- Reinforced finger joints
- Reinforced pull tab
- Sweat wipe panel on thumb
- Neoprene and VELCRO® brand wrist closure

Black. Sizes: S-2X, see size chart O on p. 99

6R1-GL402 \$27.99



HATCH

Hatch® Dura-Thin Police Search Gloves

Protect your hands with these best-selling gloves from Hatch.

- Unlined and made of soft, durable cowhide leather
- Thin for superior feel and dexterity
- Elasticized cuff for a snug fit; will not interfere with jacket or shirt cuffs
- Wrist length

Black. Sizes: S-2X, see size chart P on p. 99

6R1-GL527 \$29.49



A Step Up in Value

GALLS®

Starting at
\$54⁹⁹

30-Day Comfort Guarantee

If you are not completely satisfied with your footwear within the first 30 days, send them back for a full refund or exchange. For more details, visit galls.com/footwear.

Galls® Footwear

These styles are lightweight, long-wearing and a tremendous value!

- Leather/nylon
- Abrasion-resistant, padded collar for durability and comfort
- Long-wearing rubber outsole has a multi-directional configuration for maximum traction and surface contact; outsole is also slip and oil resistant

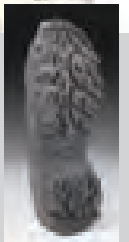



**NEW
WOMEN'S
SIZING**

Galls® 8" Duty Boots

- Taibrelle® lining and removable insole wicks away moisture to keep feet dry
- Water resistant
- Lightweight fiberglass shank reduces fatigue
- Zipper boots have YKK® side zipper with leather tab cover for easy on/off

Sizes: 4-12, 13, 14, 15 medium and wide widths

Description	Item	Price
Men's Non-Zipper	6R1-FX068	\$59.99
Men's Zipper	6R1-FX066	\$64.99
Women's Zipper	6R1-FX067	\$64.99

Composite Toe: The toe protection you need in a lightweight and flexible style.

- Meets ASTM-F2413-05 safety toe standards
- Steel toe for protection and durability
- Antimicrobial/antibacterial lining on boot and removable insole provides protection against odor

6R1-FX069 \$74.99

Galls® 5" Quarter Boots

- Water resistant
- Steel shank for durability

Sizes: 4-12, 13, 14, 15 medium and wide widths

\$54.99

Men's	6R1-FX070
Women's	6R1-FX071



8"



5"

VISIT US ONLINE

Shop our full selection of footwear online at:
galls.com/footwear

Budget-Friendly Comfort and Quality



Oxford

Quarter

8" Duty

DutyPro™ Footwear
Starting at
\$29.99

DutyPro™

DutyPro™ Footwear

Our basic footwear offers lightweight comfort at an affordable price.

- Leather/ballistic nylon upper
- Mesh/EVA lining for added cushioning
- Shock absorbing outsole
- Padded tongue and collar

Sizes: Men's 4-12, 13, 14 medium and wide width

Description	Item	Price
Oxford	6R1-FW311	\$29.99
Quarter	6R1-FW312	\$34.99
8" Duty	6R1-FW313	\$39.99



VISIT US ONLINE

Choose from hundreds of footwear items online at:
galls.com/footwear



Low Oxford

6" Quarter

8" Duty

LawPro®

LawPro® Dispatch 2.0 Footwear

With LawPro Dispatch 2.0 boots, you don't have to pay a lot to get the comfort and quality construction you expect in your duty footwear.

- Leather and 900-denier nylon upper provides exceptional durability
- Quick-drying, removable molded EVA sockliner keeps feet dry
- Perforated padded collar provides comfort and breathability
- Slip and oil resistant rubber outsole provides solid traction

Sizes: Men's 3-12, 13, 14, 15 medium width; 7-12, 13, 14, 15 wide width

Description	Item	Price
Low Oxford	6R1-FW661	\$44.99
6" Quarter	6R1-FW660	\$49.99
8" Duty	6R1-FW658	\$49.99
8" Side Zip Duty	6R1-FW659	\$54.99



8" Side Zip

We Accept these Major Credit Cards





Side-zip
for easy on
and off



Response III
8" Side-Zip



Magnum® Response III Duty Boots

These lightweight boots give you the support and comfort you need all day. They're ready for action, value priced and withstand the daily demands on duty.

- Slip and oil-resistant outsole
- Action leather and nylon upper delivers ultimate performance, agility and durability
- Contoured, removable sock liner

Black. Sizes: 7-12, 13, 14, 15 medium width; 8-12, 13, 14, 15 wide width

Description	Item	Price
6"	6R1-FT457	\$65.00
8"	6R1-FT455	\$70.00
8" Side-Zip	6R1-FT456	\$80.00



Add a zipper for
only \$5 more

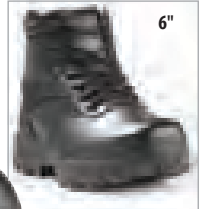

8" Side-Zip



Dickies® Spear Tactical Boots

Tactical work boots give you sure-footed traction on various surfaces and the comfort of athletic shoes.

- SP193 Steel Toe Meets ASTM F2413-11 standards
- Full-grain leather upper
- Abrasion resistant nylon panels
- Padded collar and tongue
- Fully lined with moisture-wicking performance fabric
- Premium shock-absorbing PU insole
- Lightweight EVA midsole
- Oil and slip resistant rubber outsole

Black. Sizes: medium width in 7, 8-11, 12, 13, 14 and 15

Description	Item	Price
6"	6R1-SP192	\$69.99
6" Steel Toe	6R1-SP193	\$74.99
8" Side-Zip	6R1-SP191	\$74.99



- EVA Midsole
- Ethylene Vinyl Acetate
 - Lightweight
 - Durable
 - Cushioned



Original S.W.A.T.® Men's 8" Force Duty Boots

The Force series is tactically engineered to deliver innovative performance and comfort-focused boots to the uniform market at the best possible value. Carbon rubber slip-resistant, non-marking outsole.

- Exceeds ASTM F489-96 safety standards for slip resistance
- Removable custom-fit EVA insole
- Moisture-wicking lining with AEGIS antimicrobial protection
- Steel shank for superior support

Black. Sizes: 4-12, 13, 14, 15, 16 regular width; 7-12, 13, 14, 15, 16 wide width

Side-Zip: YKK® side-zipper for easy on and off

6R1-FT451 \$69.99

Waterproof: Bloodborne-pathogen resistance and waterproof construction

6R1-FT452 \$79.99



Side-zip for easy
on and off

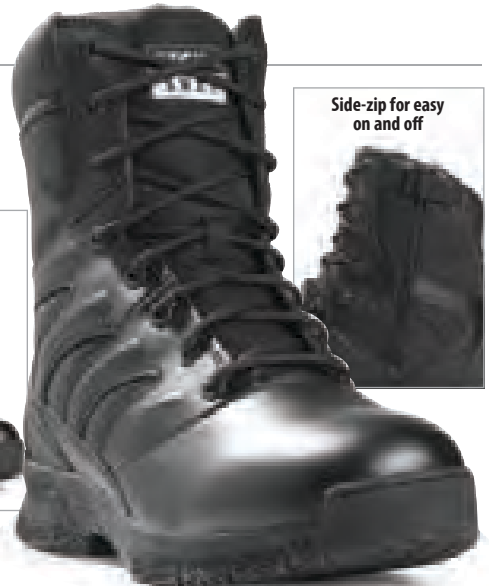
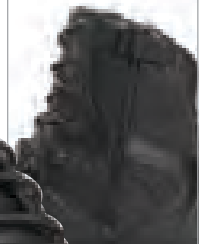

ORIGINAL
S.W.A.T.

Original S.W.A.T. Chase Footwear

- Long-lasting wear with slip resistant performance
- Polishable full-grain leather toe and 1200-denier nylon upper
 - Moisture-wicking lining with AEGIS antimicrobial protection
 - Custom molded phylon midsole for lightweight comfort and cradled support
 - Slip- and oil-resistant rubber outsole
 - Siping and ladder grip control treads
 - Stitched toe and heel

Sizes: 4-12, 13, 14, 15, 16 in medium width and 7-12, 13, 14, 15, 16 in wide width.



9" Waterproof Side-Zip

NEW



9" Side-Zip Black

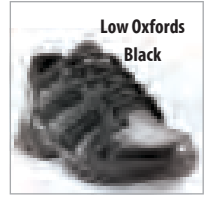

Low Oxfords Black



9" Side-Zip Desert Tan



9" Side-Zip Black

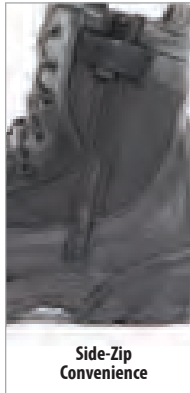

Side-Zip Convenience

Original S.W.A.T.® Chase Boots

Invest in long-lasting wear with reliable performance and odor control. 9" available in Scotchguard™ treated suede.

Description	Item	Price
Low Oxfords Black	6R1-FW941	\$74.99
9" Side-Zip Black	6R1-FW682	\$94.99
9" Side-Zip Desert Tan	6R1-FW698	\$94.99

Original S.W.A.T.® 9" Chase Waterproof Boots

The slip-resistance of the Chase outsole combined with waterproof and bloodborne pathogen resistant protection.

- Waterproof
- Bloodborne pathogen resistant
- Gusseted tongue protects against dirt and debris
- Removable EVA insole (See p. 141) with PORON® cushioning pads
- Texon stability platform for lateral support and torsional rigidity
- Airport friendly nylon shank
- PU collar with ventilating perforations
- Foam padded collar and tongue
- Rustproof hardware
- Thermoplastic heel counter and toe box
- Heel flex notch

Side-Zip: YKK® side-zipper for easy on/off

- Slip- and oil-resistant, non-marking rubber with siping, exceeds the ASTM F489-96 test for slip resistance
- HydroGuard waterproof full bootie construction
- YKK® side-zipper

Black.

6R1-FX110 \$104.99

Electrical Hazard Protection: Meets ASTM F2412-11 and F2413-11 for electrical hazards.

- Exceeds the ASTM F489-96 test standards, non marking
- Electrical Hazard protection – ASTM F2412-11 and F2413-11
- Waterproof, breathable lining

Black.

6R1-FW683 \$119.99



Rocky® 8" Fort Hood Waterproof Duty Boots

Guaranteed Rocky® waterproof construction.

- Leather, 1000 denier nylon upper
- Padded leather collar
- Fiberglass shank
- Abrasion-resistant rubber SWAT outsole

Black. Sizes: medium and wide widths in 7-12, 13, 14 and 15

6R1-SP649 \$82.99

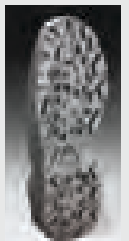

Slip-Resistant Traction



9" Black



9" Side-Zip Black

Add a side-zip for only a few dollars more



Original S.W.A.T.® Classic Boots

Uniform-code leather duty boot, outstanding lateral support.

- Meets ASTM F489-96 test standards for slip resistance
- Uniform-code duty boot with polishable full-grain leather toe and 100-denier nylon triple-stitched upper
- Riveted steel shank
- Compression molded EVA (See p. 141) midsole

Colors: (Men's 6") Black, Coyote. (Women's 6") Black. (Men's 9") Black, Tan, Coyote, Brown. (Men's 9" Side-Zip) Black, Tan. (Women's 9" Side-Zip) Sizes: Men's 4-12, 13, 14, 15, 16 in medium width; 7-12, 13, 14, 15, 16 in wide widths. Women's 6-11.

Description

	Item	Price
Men's 6"	6R1-FW844	\$88.39
Women's 6"	6R1-FW952	\$88.39
Men's 9"	6R1-FW845	\$91.79
Men's 9" Side-Zip Black	6R1-FW945	\$94.99
Men's 9" Side-Zip Tan	6R1-FW946	\$94.99
Women's 9" Side-Zip Black	6R1-FW953	\$94.99

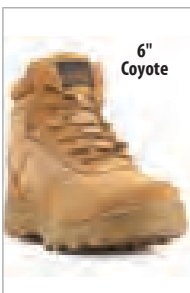

6" Coyote

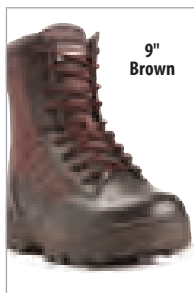

9" Brown



Check descriptions for availability

30-Day Comfort Guarantee

If you are not completely satisfied with your footwear within the first 30 days, send them back for a full refund or exchange. For more details, visit galls.com/footwear.

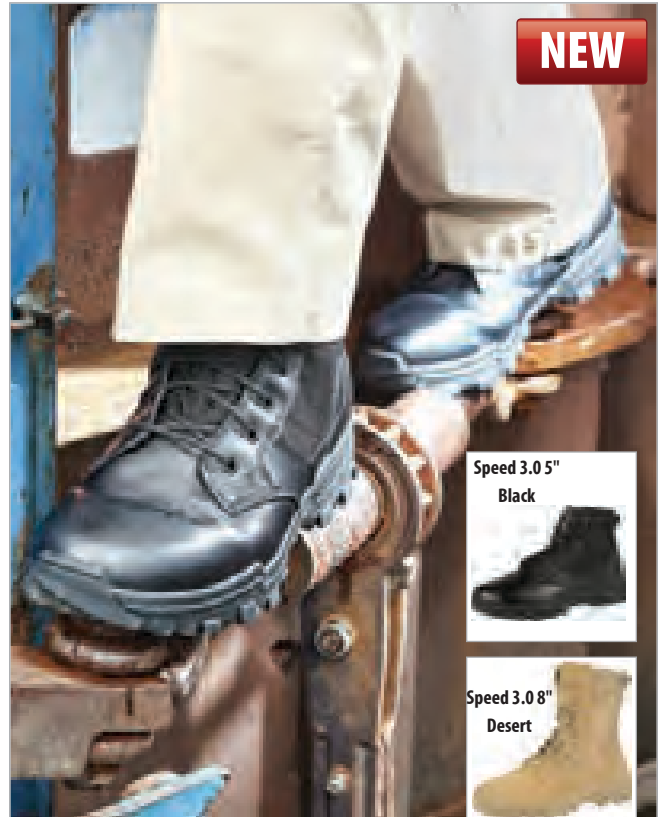

NEW

Speed 3.0 5" Black



Speed 3.0 8" Desert



Speed 3.0 Jungle Black



Speed 3.0 Jungle Dark Coyote



Speed 3.0 Urban Black



5.11

5.11 Tactical® Speed 3.0 Boots

Designed for speed, these boots are ready to traverse any urban jungle and tackle any training regimen without a misstep. Cupsole construction from 5.11 provides slip and oil resistance for surefooted landing and propulsion, with a multi-terrain tread pattern for serious traction. Self-cleaning forefoot lugs are an added advantage, lessening the amount of dirt and debris that would usually build up over time. Constructed from full-grain leather for classic comfort and ripstop nylon for long-lasting wear.

- Full-grain leather with ripstop nylon
- OrthoLite® insole for cushioning and comfort
- OrthoLite® stroble sock for additional cushioning and comfort
- Agion® antimicrobial treatment on lining
- 5.11® cupsole construction: one-piece outsole with self-cleaning forefoot lugs, fence climbing toe, slip/oil resistance and multi-terrain tread pattern
- 14mm heel-to-toe drop
- Polishable toe
- YKK® side zipper
- Imported

Colors: Black (FX191, FX194, FX196), Dark Coyote. (FX193), Desert (FX192). Sizes: 4, 5, 6-12, 13, 14, 15

Description

	Item	Price
Speed 3.0 5"	6R1-FX196	\$84.99
Speed 3.0 8"	6R1-FX192	\$89.99
Speed Urban 3.0 Side-Zip	6R1-FX191	\$89.99
Speed 3.0 Jungle (Dark Coyote)	6R1-FX193	\$89.99
Speed 3.0 Jungle (Black)	6R1-FX194	\$89.99



Ordering online? Use your **PROMOTIONAL CODE** from the back cover

800.477.7766 • galls.com

143

Hidden storage pocket



8"



8" Shield



8" Coyote Tan

Attack any Terrain

5.11

5.11® A.T.A.C.® 6" Quarter Boots

This ankle-height boot has a polished toe for a professional look.

- Leather and Cordura® nylon side panels
- Fiberglass shank
- Water resistant, antimicrobial
- Antibacterial DriLex® lining
- Four-system compression recovery insole

Black. Sizes: Men's (non-zipper) 8-12, 13, 14 medium width; 9-12, 13 wide width. Men's (zipper) 4, 5, 6-12, 13, 14, 15 medium width; 7-12, 13 wide width. Women's (zipper) 5, 6-10 medium width

\$89.99

- Men's Non-Zipper **6R1-SP584**
- Men's Side-Zip **6R1-FW138**
- Women's Side-Zip **6R1-FW339**

5.11® A.T.A.C.® 8" Side Zip Boots

Ideal for everyday patrol with the convenience of a side-zipper and water resistance.

- Durable, leather upper with Cordura® nylon side panels
- YKK® side zipper with leather tab cover
- Antibacterial DriLex™ lining
- Composite shank
- Hidden side pocket
- Shock Mitigation System™ for extended comfort

Black. Sizes: Men's 8-12, 13, 14, 15 medium width; 9-12, 13 wide width. Women's 5, 6-10 medium width

\$99.99

- Men's **6R1-SP583**
- Women's **6R1-FW069**

Coyote Tan: Durable, supple suede leather upper with 1200 denier Cordura® nylon side panels. Water resistant.

Coyote Tan. Sizes: Men's 8-12, 13-15, medium width; 8-12, 13 wide width. Women's 5, 6-10 **6R1-SP866 \$99.99**

Waterproof Storm: Full-grain waterproof leather and nylon upper boots with a Phylon midsole for comfort.

Black. Sizes: Men's 8-12, 13-15 medium width; 8-12, 13 wide width. Women's 5, 6-10

\$139.99

- Men's **6R1-SP725**
- Women's **6R1-FW412**

5.11® A.T.A.C.® 8" Shield Composite Toe Waterproof Side Zip Boots

Protects toes from injury and bloodborne pathogen-resistant lining provides protection.

- Meets ASTM-F2413-05 safety toe standards
- Waterproof leather upper with a polishable toe
- YKK® side zipper and leather tab cover
- DriLex® lining
- Fiberglass shank

Black. Sizes: Men's 5, 6-12, 13, 14, 15 medium width; 7-12, 13 wide width. Women's: 5-10 medium width

- 6" Men's **6R1-FW140 \$129.99**
- 8" Men's **6R1-FW139 \$154.99**
- 8" Women's **6R1-SP079 \$154.99**



6"



6" Side-Zip



8" Side-Zip

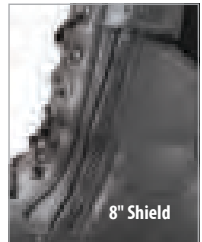

8" Shield



6" Shield

5.11® A.T.A.C.® Footwear

A.T.A.C.® (All Terrain, All-Condition) Boots protect you from stride impact and keep you dry in most environments.

- Oil and slip-resistant A.T.A.C. outsole with Sniper Prone Position Grips gives traction on any surface
- 5.11 Shock Mitigation System™ for internal comfort and shock absorption

Rugged Reliability for Wherever Duty Takes You



8"



Magnum® Viper Pro Waterproof Boots

Magnum stays true to its roots of creating lightweight, athletic-inspired tactical boots with the Viper family of uniform footwear. The Viper boots are built to take on any job that duty throws its way.

- Full-grain, Magna shield leather/1650 denier nylon upper
- Clarino microfiber collar
- Waterproof bootie construction
- Non-metallic hardware
- M.P.A.C.T. Response footbed for maximum comfort and shock absorption
- Ankle protection for support
- High traction outsole for maximum grip and slip resistance
- EVA (See p. 141) midsole

Black. Sizes: medium width in 4-12, 13, 14, 15 and 8-12, 13, 14, 15 in extra-wide width

Description	Item	Price
5"	6R1-SP030	\$90.00
8" Side-Zip	6R1-SP034	\$100.00



5"

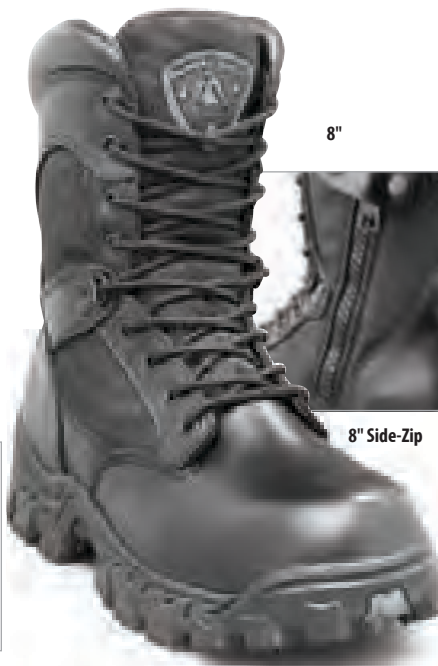

8"



8" Side-Zip

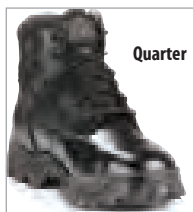

Quarter



Rocky® Alpha Force Footwear

Lightweight construction and waterproof protection makes this boot a double winner.

- Composite Toe: *meets ASTM-F2413-05 safety toe standards*
- Full-grain leather/1000 denier nylon
- Guaranteed Rocky® waterproof construction with aqua-guard liner
- Fiberglass shank
- Oil and slip-resistant RigiTrac outsole is non-marking
- Terra-suspension footbed for added cushioning and support

Black. Sizes: Men's 8-12, 13 medium and wide widths

Description	Item	Price
Quarter	6R1-SP639	\$91.99
8" Side-Zip	6R1-SP529	\$100.99
8" Waterproof	6R1-SP648	\$102.99
6" Composite Toe	6R1-SP640	\$105.99



8"



Side-zip for easy on and off



Magnum® Viper Pro III Boots

Demand ultimate performance with lightweight upper, high traction outsole and M.P.A.C.T. Response shock absorption.

- 1650 denier nylon upper and full-grain Magna shield leather
- Durable upper lightweight materials
- High traction outsole for grip and slip resistance
- M.P.A.C.T. Response footbed for comfort and shock absorption

Black. Sizes: 7-12, 13, 14 medium and wide width

6R1-FW494 \$95.00



VISIT US ONLINE



Find more of your favorite footwear online at: galls.com/footwear

Comfort, Support



8"

LOWER PRICES



5" Quarter

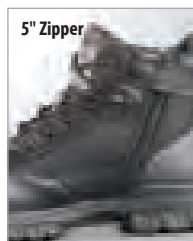

5" Zipper

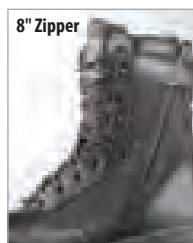

8" Zipper



8" Waterproof Side-Zip

8" Duty



Tactical Research TR Chrome® Side-Zip Boots

Take on tough turf with structured intensity. The high stability, "Hot Fusion" Exo-Skeletal frame, aggressive features and side-zip convenience give these boots a tactical advantage.

- Cowhide leather and destination P nylon mesh exterior
- Breathable Aero-Spacer hydrophilic mesh lining
- "Hot Fusion" Exo-Skeletal frame for structural support
- Long-wearing StreetNav™ rubber outsole
- Non-marking, oil- and slip-resistant outsole
- Compression molded midsole for lightweight comfort
- Double pour polyurethane cushioned insert
- Cleat and lug outsole for top level traction
- Ghillie lacing system hugs the boot to your foot
- Low profile lace-lock hook



6" Quarter

Black. Sizes: 6-12, 13, 14, 15 in regular and wide widths

Side-Zip: Side-zipper entry for quick changes

Description	Item	Price
6" Quarter	6R1-FT006	\$94.99
8" Duty	6R1-FT007	\$99.99

Waterproof Side-Zip: Bloodborne pathogen proof protective membrane. Side-zipper entry with molded security overlay

Description	Item	Price
6" Quarter	6R1-FT008	\$119.99
8" Duty	6R1-FT009	\$124.99

Bates® Tactical Sport Footwear

Perfect for passing through security checkpoints. Lightweight for all-day wear.

- Made of full grain leather and 1680 ballistic nylon uppers
- Non-metallic components – will not trigger security alarms
- Oil and slip-resistant Ultra-Lites® Xtreme rubber outsole provides ergonomic support

Bates® Tactical Sport 5" Quarter Boots

Removable, cushioned footbed with shock absorbing pads and a compressed EVA (See p. 141) midsole for comfort.

- Fiberglass shank
- 30% lighter, 35% more flexible compared to similar boots
- 41% heel, 18% forefoot improved shock absorption



Quarter: Breathable PK mesh lining absorbs moisture.

Sizes: Men's medium and extra wide widths in 8-12, 13, 14 and 15. Women's sizes: medium width only in 5-10

WAS \$94.95 **NOW \$89.95**

Men's **6R1-SP620**
Women's **6R1-SP703**

Composite Toe:

We've added smaller sizes to fit women!

- Meets ASTM-F2413-05 safety toe standard and ANSI Z41 PT99 M1/75 C/75 requirements
- YKK® side zipper with leather tab cover
- Non-metallic zipper

Men's sizes: medium in 4-12, 13, 14 and extra wide width in 7-12, 13 and 14

6R1-SP594 \$114.95

Bates® Tactical Sport 8" Duty Boots

Features a fiberglass shank in addition to other features listed below.

- EVA insert (See p. 141) has a shock-absorbing polyurethane heel and forepart pads
- Lightweight Insert provides cushioning

Men's sizes: medium and extra wide widths in 8-12, 13 and 14. Women's sizes: medium widths only in 5-10

Description	Item	Price
Standard	6R1-SP402	\$104.95
Water Resistant	6R1-SP527	\$119.95

Bates® Tactical Sport 8" Zipper Boots

Features YKK® side zipper with leather tab cover. Watch the video @ galls.com.

Sizes: Men's medium and extra wide widths 8-12, 13 and 14. Women's sizes: medium width only in 5-10

WAS \$109.95 **NOW \$99.95**

Men's Zipper	6R1-SP403
Women's Zipper	6R1-SP404

Composite Toe Zipper:

- Meets ASTM-F2413-05 safety toe standards
- Removable shock-absorbing insole with DriLex™ cover

Men's sizes: medium and extra wide widths in 8-12 and 13

6R1-SP526 \$119.95

and Tactical Utility



8" Side-Zip
Black



8"
Coyote



8"



Side-Zip

★ PROPPER™

PROPPER™ Series 100 Boots

Tread any terrain with the aggressive traction and impact absorption that the oil- and slip-resistant outsole supplies.

- Antimicrobial lining inhibits odor, promotes breathability and increases wear
- Open cell air mesh foam keeps air circulating around foot for continual comfort
- Washable open cell foam inserts conform to foot for balance and arch support
- Fast-rope compatible arch is built to handle ladders and fast-rope
- Coated speed lace hardware with 550 paracord lacing adds durability

Sizes: 5-13, 14, 15 M, 5-13, 14 W

6" Side-Zip: Polishable leather with 1000D nylon upper. YKK® side-zipper with hook-and-loop zipper guard. Color: Black

6R1-FT937 \$99.99

8" Side-Zip: Polishable leather with 1000D nylon upper. YKK® side-zipper with hook-and-loop zipper guard. Color: Black

6R1-FT935 \$104.99

8": Water-resistant suede. Color: Coyote

6R1-FT936 \$109.99

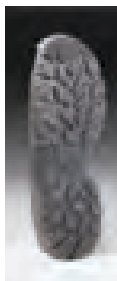

6" Side-Zip

BATES



4"



6"

Bates® Code 6 Side-Zip Boots

Change into the latest Code 6 boots for exceptional breathability and lightweight performance. Hexagon nylon design offers ripstop durability.

- Moisture-mesh lining
- Flexible cement construction
- Reinforced toe and heel stitching for added durability
- V-Fit Comfort Lacing Technology allows for greater mobility

Sizes: Men's 7-12, 13, 14, 15 medium width; 7-12, 13, 14 extra-wide width. Women's 5-10 medium width

Description	Item	Price
Men's 4"	6R1-FT030	\$104.95
Men's 6"	6R1-FT029	\$114.95
Men's 8"	6R1-FT027	\$119.95
Women's 8"	6R1-FT028	\$119.95



VISIT US ONLINE



Shop our full selection of Bates footwear online at:
galls.com/brands/bates

30-Day Comfort Guarantee

If you are not completely satisfied with your footwear within the first 30 days, send them back for a full refund or exchange. For more details, visit galls.com/footwear.



Side-Zip Convenience

NEW



Waterproof Coyote

ORIGINAL
S.W.A.T.

Original S.W.A.T.® Men's H.A.W.K. 9" Side-Zip Duty Boots

Designed to deliver performance and durability first, this boot takes every measure to ensure technical lightweight standards are met.

- Exceeds the ASTM F489-96 safety standard for slip resistance
- Removable, lightweight custom-fit ethylene vinyl acetate (EVA) midsole with a shock-absorption zone for comfort and fatigue control
- Moisture-wicking lining with AEGIS antimicrobial protection
- Lightweight, arch ladder grips and toe grips for climbing
- Oil-resistant, non-marking rubber outsole

Black. Sizes: 4-12, 13, 14, 15, 16 in regular width; 7-12, 13, 14, 15, 16 in wide width

6R1-FT449 \$109.99

Waterproof Side-Zip: Blood-borne pathogen resistance and full waterproof bootie construction

6R1-FT450 \$129.99

Waterproof: Suede leather with hydroGuard waterproof full bootie construction. Bloodborne pathogen resistant.

Coyote

6R1-FX109 \$129.99

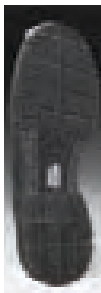

6" Quarter

8" Duty

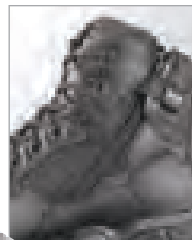

Add a Side-Zip for \$5

MAGNUM

Magnum® Stealth Force Boots

Magnum® Stealth Force Boots were made to keep you safe and steady on any terrain, wet or dry.

- Full-grain leather/1680 denier ballistic nylon mesh upper
- Agion™ antibacterial treatment to prevent odor
- Composite shank and durable non-metallic composite hardware
- Compression-molded EVA (See p. 141) midsole
- Non-metallic composition will not trigger security alarms
- X-Traction Zone Outsole provides enhanced grip and stability – even on wet surfaces! Includes fence grip toe and ladder/step grip zones



\$110.00

6" **6R1-FW273**

8" **6R1-SP935**

Zipper: Time-saving convenience of a YKK® side circular zipper with nylon tab cover for easy on/off. 6" sizes: medium and wide widths in 7-11½, 12, 13 and 14.

8" sizes: medium and wide widths in 8-12, 13-14

Desc.	Item	Price
6"	6R1-SP940	\$110.00
8"	6R1-SP937	\$115.00

Composite Toe Zipper: All the features of SP937, with the added safety and protection of a composite toe.

- Meets ASTM-F2413-05 safety toe standards and EN ISO 20347 certified
- YKK® circular side zipper with nylon tab for easy on/off
- Cambrelle® moisture-wicking lining to keep dry
- Coats Barbour anti-fraying stitching thread
- Flex-Zone with siping for traction and control

Composite Toe Men's 8" Zipper: Men's sizes: medium and wide widths in 8-12, 13-14.

6R1-SP934 \$125.00

Waterproof Composite Toe Zipper 8" Duty: All the benefits of a composite toe combined with waterproof comfort! Sizes: medium and wide widths in 7-11½, 12, 13 and 14

6R1-FW280 \$130.00



8"



8" Composite Toe Zipper



8" Waterproof Composite Toe Zipper

Heavy-Duty Performance Without the Weight



8" LE
Black



8" LE
YKK® Side-
Zipper



8" Military
Coyote



8"



8" Side-Zip



6"



Coyote

★ PROPPER™

PROPPER™ Series 200 Boots

Vibram® composite rubber outsole delivers serious grip and provides a stable platform for confidence on any surface.

- Aegis antimicrobial and breathable lining prevents odor buildup and prolongs wear
- Oil- and slip-resistant Vibram composite rubber outsole provides gripping traction
- Fast-rope compatible arch is built to handle ladders and fast-rope
- Coated speed lace hardware with 550 paracord lacing adds durability

Sizes: 5-13,14,15 M, 5-13,14 W

LE Side-Zip: Polishable full-grain leather upper. YKK® side zipper with hook-and-loop zipper guard. Color: Black

Description	Item	Price
6"	6R1-FT946	\$114.99
8"	6R1-FT938	\$119.99
6" Waterproof	6R1-FT947	\$124.99
8" Waterproof	6R1-FT945	\$129.99

Military: AR-670-1 Compliant full-grain leather upper. Color: Coyote

Description	Item	Price
8"	6R1-FT939	\$129.99
8" Waterproof	6R1-FT944	\$139.99



6"

5.11

5.11 Tactical® EVO Side Zip Boots

5.11's EVO boots excel in provide stability and lightweight performance.

- Polishable, full-grain leather with 1200 denier nylon
- Non-metallic construction
- YKK® side zipper
- OrthoLite® insole
- Full length EVA midsole (See p. 141)
- 511 outsole with fence climbing lugs
- 14mm heel to toe drop for a responsive feel and more natural stance
- Slip and oil resistant
- Sausage laces stay tied

Black. Sizes: 6-12, 13, 14, 15 medium width; 6-12, 13, 14 wide width

Description	Item	Price
6" Side-Zip	6R1-FT750	\$114.99
8" Side-Zip	6R1-FT581	\$124.99

Desert: Suede upper. Coyote
6R1-FX046 \$124.99

Waterproof: eVent® waterproof, breathable and bloodborne pathogen resistant membrane

Description	Item	Price
6" Side-Zip	6R1-FT751	\$134.99
8" Side-Zip	6R1-FT749	\$144.99

Insulated: Insulated with 400g PrimaLoft for warmth. Full-grain leather upper
6R1-FX061 \$144.99

8" CST Waterproof: Waterproof, puncture-resistant package for increased safety.
6R1-FX195 \$179.99



VISIT US ONLINE



Shop our full assortment of duty boots online at:
galls.com/duty-boots

Ordering online? Use your **PROMOTIONAL CODE** from the back cover

800.477.7766 • galls.com

149

Timberland Pro® Valor Dynamic Anti-Fatigue Technology™

Fight Fatigue



NEW

Timberland Pro® Valor™ Duty Boots

Built for public safety professionals, Timberland Pro® boots combine rugged durability and comfort. Exclusive Anti-Fatigue Technology™ absorbs shock and returns energy at key zones of the foot for comfort. Molded, inverted cones support, collapse and return energy in key pressure zones, and the cone structure uses less material for a lighter boot. Backed by Timberland Pro's 30-Day Comfort Guarantee.

- Leather construction
- Dynamic Anti-Fatigue Technology absorbs shock and returns energy at key zones of the foot for all-day comfort
- Mesh lining with antimicrobial treatment for odor control and comfortable feet
- Cement construction for flexibility and reduced break-in-time
- Lightweight molded EVA midsole (see p. 141) for athletic performance
- Scotchgard™ protector by 3M® for stain resistance
- Slip and oil resistant, non-marking outsole

Black

Side Zip: Time-saving convenience of a side zipper with zipper locker for added security. Sizes: 7-12, 13, 14, 15 medium and wide widths

Desc.	Item	Price
8"	6R1-FX289	\$140.00
6"	6R1-FX294	\$130.00

Waterproof: Waterproof leather construction with a waterproof membrane to keep your feet dry and comfortable. Sizes: (8") 7-12, 13, 14, 15 medium and wide widths, (6") 3½-12, 13, 14, 15 medium and wide widths

Desc.	Item	Price
8"	6R1-FX291	\$155.00
6"	6R1-FX292	\$145.00

Side Zip Waterproof: Waterproof leather construction with a waterproof membrane as well as a convenient side zip with zipper locker. Sizes: (8") 7-12, 13, 14, 15 medium and wide widths, (6") 3½-12, 13, 14, 15 medium and wide widths

Desc.	Item	Price
8"	6R1-FX295	\$160.00
6"	6R1-FX288	\$150.00

Side Zip Waterproof Composite Toe: Non-metallic, non-magnetic composite toe cap meets ASTM F2412-11, F2413-11, 1/75 and C/75 impact and compression safety standards. Waterproof leather construction with a waterproof membrane as well as a convenient side zip with zipper locker. Sizes: 3.5-12, 13, 14, 15 medium and wide widths

Desc.	Item	Price
8"	6R1-FX293	\$170.00
6"	6R1-FX290	\$160.00



6" Waterproof

Side-Zip

8" Waterproof



8" Side-Zip Waterproof

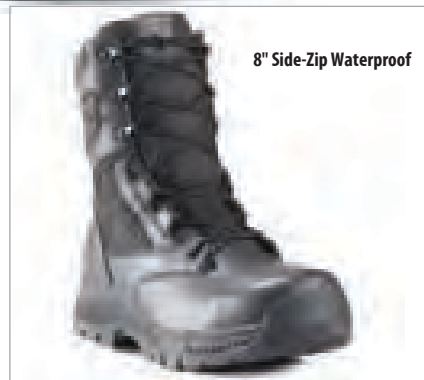

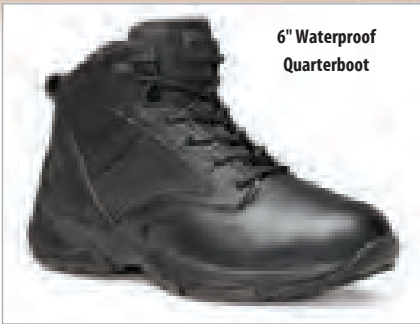
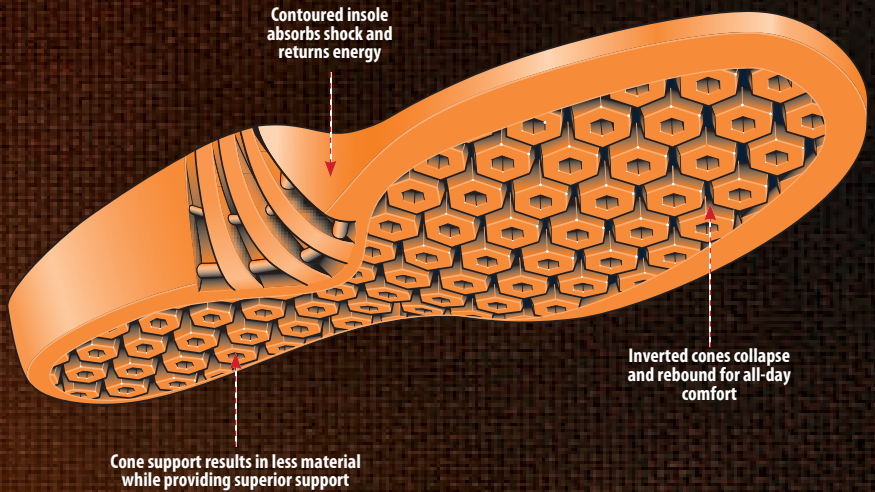

6" Waterproof Quarterboot



8" Waterproof Side-Zip Duty Boot



High-Rebound Replacement Insole



Anti-Fatigue Replacement Insole



8" Side-Zip Duty Boot

VISIT US ONLINE

Timberland Men's Pro Valor Newmarket Oxfords (SP086) also features Anti-Fatigue Technology™. See it today at galls.com

Timberland® Valor Tactical Boots

Built for public safety professionals, Valor Tactical boots combine rugged durability and comfort. Exclusive Dynamic Anti-Fatigue Technology absorbs shock and returns energy at key zones of the foot for all-day comfort.

- Meets ASTM F2892-11 for electrical hazard protection
- Clarino microfiber forefoot with 800D nylon upper panels for lightweight durability
- Non-metallic shank and hardware are metal detector friendly
- Dynamic Anti-Fatigue Technology™ absorbs shock and returns energy for all-day comfort
- Mesh lining with antimicrobial treatment for odor control and comfortable feet
- Cement construction for flexibility and reduced break-in-time
- Lightweight molded EVA midsole (see p. 141) for athletic performance
- Vibram® performance rubber outsole features slip, oil and abrasion resistance
- Brake and flex zoned system to support and propel
- Scotchgard™ protector by 3M® for stain resistance

Sizes: Men's medium and wide widths in 7-12, 13, 14, 15

Description	Item	Price
6" Quarterboot	6R1-FT979	\$115.00
6" Waterproof Quarterboot	6R1-FT980	\$140.00
5" Waterproof Side-Zip Quarterboot	6R1-FT981	\$145.00
8" Side-Zip Duty Boot	6R1-FT983	\$130.00
8" Waterproof Side-Zip Duty Boot	6R1-FT984	\$150.00
Timberland PRO® High-Rebound Replacement Insole	6R1-FT985	\$17.99
Timberland PRO® Anti-Fatigue Replacement Insole	6R1-FT986	\$30.00

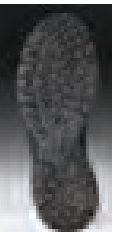

Ordering online? Use your **PROMOTIONAL CODE** from the back cover

800.477.7766 • galls.com



Side-Zip Performance



Bates® 8" Insulated Steel Toe Zipper Boots

Thinsulate® with mesh lining lets your feet breathe and stay comfortable.

- Leather/Cordura® construction
- 200 grams Thinsulate®; mesh lining absorbs perspiration
- Removable insert with comfort cushion
- Slip-resistant rubber outsole
- YKK® side zipper with leather tab cover
- D-ring lacing with parachute laces
- Nylon shank

Black. Sizes: medium and wide widths in 8-11½, 12 and 13

6R1-SP498 \$124.95



8"



6"



Bates® Strike Waterproof Zipper Boots

Built with Bates' anti-fatigue endurance performance system, these boots deliver the durability you need and the comfort you demand.

- Waterproof leather and nylon upper with protective TPU panels
- Waterproof inner membrane
- YKK® nylon side zipper
- Anti-fatigue endurance performance system
- Dual density EVA midsole (See p. 141) mitigates shock
- Slip-resistant multi-terrain rubber lug outsole

Black. Sizes: Men's 7-12, 13, 14, 15 M, 7-12, 13, 14 W

Description	Item	Price
6" Quarter	6R1-FT970	\$129.95
8" Duty	6R1-FT971	\$134.95



30-Day Comfort Guarantee

If you are not completely satisfied with your footwear within the first 30 days, send them back for a full refund or exchange. For more details, visit galls.com/footwear.

We Accept these Major Credit Cards



Waterproof Performance and Comfort



LOWER PRICES

8"



Bates® Tactical Sport GORE-TEX® Boots
Breathable, waterproof Tactical Sport GORE-TEX Boots serve and protect in any weather.

- Perfect for passing through security checkpoints
- Lightweight for all-day wear
- Made of full grain leather and 1680 ballistic nylon uppers
- Non-metallic components – will not trigger security alarms
- Oil and slip-resistant Ultra-Lites® Xtreme rubber outsole
- Nylon shank
- Fully cushioned and removable footbed with shock absorbing pads and a compressed EVA (See p. 141) midsole provide added comfort

Sizes: 8-12, 13 and 14 medium and extra-wide widths. Women's sizes: 5-10 and 11 medium

4" Quarter Boots: Shorter, quarter boot style is light and agile

WAS \$139.95 **NOW \$129.95**
Men's **6R1-SP757**
Women's **6R1-SP758**

8" Side-Zip Duty: YKK® side zipper with nylon tab cover and interior gusset for easy on/off

WAS \$154.95 **NOW \$144.95**
Men's **6R1-SP755**
Women's **6R1-SP756**

8" Side-Zip Insulated: 200 gr Thinsulate™ insulation!
Men's sizes: medium and extra-wide widths in 8-12, 13 and 14

6R1-FW082 \$159.95

8" Side-Zip Composite Toe: Meets ASTM-F2413-05 safety toe standards

Men's sizes: medium and extra wide widths in 8-12, 13 and 14
6R1-SP845 \$179.95



8"



Thorogood™ GEN-flex2 Waterproof Side-Zip Tactical Boots

Lightweight, flexible and shock-absorbing GEN-flex2 technology combines comfort and performance.

- Waterproof, oiled, full-grain leather construction
- Thoro dri™ waterproof lining
- Bloodborne pathogen compliant to ASTM F1671
- Composite safety toe meets CAN/CSA-Z195 18,000 volts electrical shock resistance standards
- Heavy-duty YKK zipper with Velcro® brand closure
- Stitchdown construction
- removable footbed with EVA (See p. 141) cushion flex insole
- Compression molded EVA midsole with Impact 300 gel heel insert
- Engineered composite shank
- GEN-flex2 dual-density rubber outsole
- Oil and slip resistant
- Multi-directional traction lug outsole

Black. Sizes: 4-12,13,14,15 M, 7-12,13,14,15 W

Description	Item	Price
6" Quarterboot	6R1-FX209	\$139.00
6" Composite Toe	6R1-FX211	\$145.00
8" Duty	6R1-FX210	\$144.00



Galls® Footwear
30-Day Guarantee
If you are not completely satisfied with your footwear within the first 30 days, send them back for a full refund or exchange. For more details, visit galls.com/footwear.

Weatherproof Storm Technology™



Black

Under Armour® Tac Zip 2.0 7" Duty Boots

Convenient side-zip allows fast on and off for instant response to emergencies. Quality construction for long wearing durability.

- Storm3 water-resistant construction
- Full-grain leather and anatomically molded upper collar for support and protection
- Convenient side-zip
- TPU heel support and protection
- Antimicrobial OrthoLite® sock liner with TPU arch support
- Cupron® antibacterial copper-infused sock liner top cover
- Internal stability midsole plate
- Rugged high-traction rubber lug outsole
- Polishable toe



Black. Sizes: 8-13, 14 medium

6R1-FT901 \$159.99

Under Armour® Speed Freek Tac 2.0 GTX 7" Waterproof Duty Boots

Perfect for everyday patrol or tactical operations, SPEEDFREEK Boots deliver big performance at an affordable price.

- Storm3 waterproof, windproof synthetic leather textile
- Full-grain waterproof leather and anatomically molded upper collar for support and protection
- GORE-TEX® breathable waterproof lining
- TPU heel support and protection
- Antimicrobial OrthoLite® sock liner with TPU arch support
- Cupron® antibacterial copper-infused sock liner top cover
- Internal stability midsole plate
- Rugged high-traction rubber lug outsole
- Polishable toe



Black. Sizes: 8-13, 14 medium

6R1-FT620 \$174.99

Under Armour® INFIL GTX 7" Waterproof Duty Boots

GTX Boots are a force of nature, with an auxetic structure for gripping action and impact absorption.

- Auxetic technology
- Storm3 waterproof, windproof synthetic leather textile
- GORE-TEX® breathable waterproof membrane
- Cupron® antibacterial copper infused sock liner top cover
- Rugged high-traction rubber lug outsole
- Scratch rubber heel overlay for added durability
- TPU toe cap and external heel support
- Carbon fiber internal shank plate

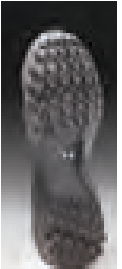

Colors: Black, Desert Sand/Bayou, Bayou. Sizes: 8-13, 14 medium

6R1-FT619 \$189.99



Desert Sand/
Bayou



Bayou

VISIT US ONLINE

Shop our full selection of Under Armour products online at: galls.com/brands/under-armour

Under Armour® Storm™ Technology

Storm 1 Water Repellent: Best for light rain situations.

Storm 2 Water Resistant & Windproof: Highly water resistant with a breathable wind block membrane.

Storm 3 Waterproof & Windproof: Fully taped and bonded seams plus an integrated and breathable Gore-Tex® with wind-stop membrane.

Heavy-Duty Haix® Footwear



High Duty



8" Duty



NEW

Mid



Low



Mid Quarter



Oxford



6" Duty

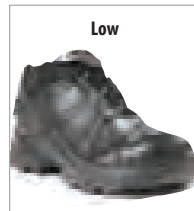

Low

Haix® Black Eagle 1.0

Designed for speed and mobility with airflow channels and extra cushioning.

- Microfiber and textile construction combines durability and high-performance in a super lightweight design
- GORE-TEX® waterproof and breathable membrane
- HAIX® Arch Support and Unique Climate Systems
- Oil, gas and slip resistant non-marking rubber outsole
- Non-metal construction



Black with gray accents. Sizes: Men's 4-13, 14, 15, 16 medium width

Description	Item	Price
Low	6R1-FW556	\$159.99
Mid Quarter	6R1-FW555	\$169.99
High Duty	6R1-FW554	\$179.99

Haix® Black Eagle Footwear

Inspired by athletic running shoe technology, the Black Eagle line from Haix® combines light weight with rugged durability. Waterproof and highly slip-resistant, Black Eagle footwear can handle any terrain.

Haix® Black Eagle Tactical 2.0

Advanced Sun Reflect to reduce the heating effect of the upper leather by direct sunlight. Sunlight is reflected, keeping the leather and your feet cooler. Metal free.

- Leather upper with sun reflect technology
- GORE-TEX® waterproof and breathable membrane
- Unique Climate System forces air circulation with every step
- Comfortable and breathable insole and separate heel frame provide outstanding cushioning
- HAIX® Arch Support System supports the natural curvature of your foot
- Oil, gas and slip-resistant non-marking rubber outsole provides excellent traction



Black. Sizes: Men's 4-13, 14, 15, 16 medium width

Description	Item	Price
Oxford	6R1-FW553	\$169.99
6" Duty	6R1-FW552	\$179.99
8" Duty	6R1-FW551	\$189.99

Haix® Black Eagle Safety 52 Boots

Simply the lightest safety shoe from HAIX®, the Black Eagle Safety 52 includes revolutionary sun reflect technology to reduce the heating effect of the upper leather by direct sunlight. Sunlight is reflected, keeping the leather and your feet cooler. A breathable, moisture-wicking insole adds even more cushioned comfort to these boots. Pronation support helps your lower leg handle shock by following the natural movement of your foot while you walk or run. Waterproof leather construction features a durable slip-resistant sole for heel-to-toe control in all climates.



- Meets ASTM F 2413-2011 standards
- Meets CAN/CSA-Z195-2014 standards
- Waterproof leather
- Carbon composite safety toe protection
- Electrical hazard rated
- Waterproof, breathable Crosstech® liner is resistant to bloodborne pathogens
- HAIX® sun reflect leather keeps feet cooler in direct sunlight
- Cushiony, moisture-wicking, antibacterial insole with airflow channels
- Metal-free, puncture-resistant midsole
- Slip-resistant, non-marking outsole is also resistant to heat, oil and gas
- Pronation support

Black. Sizes: Men's 4-13, 14, 15, 16 medium width

Description	Item	Price
Low	6R1-FX264	\$209.00
Mid	6R1-FX263	\$229.00

30-Day Comfort Guarantee

If you are not completely satisfied with your footwear within the first 30 days, send them back for a full refund or exchange. For more details, visit galls.com/footwear.

ATTENTION Departments and Agencies

We specialize in large orders to outfit your entire department or agency. Call 800.477.7766 today for discounts.



Duty

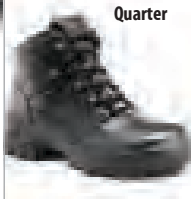

Quarter

HAIX® Airpower P7 Boots

These quick-lacing boots features a four-layer waterproof GORE-TEX® lining and the HAIX® Arch Support System for comfort and support.

- HAIX® Sun Reflect Leather keeps leather and feet cooler in hot sunlight; waterproof and breathable
- HAIX® Climate System for temperature balance
- 4-layer GORE-TEX® inner lining
- HAIX® Arch Support System for built-in support and shock absorption
- Rubber/polyurethane sole
- Non-marking, antistatic, extremely slip resistant rubber sole

Black. Sizes: Men's 4-13, 14, 15, 16 medium width

Description	Item	Price
Quarter	6R1-FW381	\$234.00
Duty	6R1-FW382	\$254.99



8" Duty



8" Side-Zip



6"



4 1/2" Duty



Danner® Striker® Torrent Duty Boots

The Striker® Torrent combines lightweight comfort with steadfast performance.

- Durable, polishable full-grain leather upper with rugged 1000-denier nylon
- 100% waterproof, breathable GORE-TEX® CROSSTECH® lining
- Light and versatile TFX-8 platform with cross stitch design for added durability
- Vibram® Striker® Torrent outsole provides maximum surface contact
- Speed lace fastening system with lace garage for a secure fit

Black. Sizes: medium and extra-wide widths in 4½-12, 13, 14 and 15. **FW726:** 6-12, 13, 14, 15 and 16 medium and wide widths. **FW727:** 5-11 available in medium only. **FW609:** medium and extra-wide widths in 3, 4-12, 13, 14, 15 and 16. **FW610:** medium and extra-wide widths in 7-12, 13, 14, 15 and 16; 6-6½ available in extra-wide width only. **FW611:** 4-11½, 12, 13, 14, 15 and 16 available in extra-wide widths only

Description	Item	Price
Men's 4½" Duty	6R1-FW726	\$179.95
Women's 4½" Duty	6R1-FW727	\$179.95
6" Side-Zip	6R1-FW609	\$199.95
8" Duty	6R1-FW610	\$209.95
8" Side-Zip	6R1-FW611	\$219.95



VISIT US ONLINE

Find more of your favorite footwear online at:
galls.com/footwear

Defy the Elements with Danner

Danner® Striker Waterproof Footwear

TFX technology is an evolution of the performance characteristics of Danner's patented TERRA FORCE™ platform.

- The overall X-frame design teams up with the fiberglass shank for unrivaled heel-to-toe energy transfer, provides traction and reduces weight. The upper and midsole provide arch and side support
- Sleek, low-profile platform gives you high performance results
- YKK® non-metal side zip (FW294, FW609, FW611) for easy on/off

Danner
SINCE 1932



Danner® Striker® GTX II EMS 8" Side-Zip Composite Toe Boots

Armor Flex III puncture-resistant midsoles and CROSSTECH® bloodborne pathogen blocking technology help keep you safe on the job.

- Flex™ II midsole *meets or exceeds ASTM F2413-05 standards* for puncture resistance
- Pro-Tec™ non-metal toe *meets or exceeds ASTM F2413-05/75 C/75 EH standards* while resisting both heat and cold
- Ideal for temperate climates
- Durable, quick to polish full-grain leather upper
- 100% waterproof, breathable GORE-TEX® CROSSTECH® lining

Black. Men's sizes: medium, double wide and narrow in 3, 5, 6-11½, 12, 13, 14, 15 and 16

6R1-FW294 \$249.95



Convenient
Side-Zip



Military-Inspired Design,



Thorogood™ All-Leather Side-Zip Jump 8" Boots

Classic style for law enforcement professionals.

- Oil-tanned leather with high shine cap and heel counter
- Goodyear welt construction for a better fit and durability
- Dri-Lex® Aero-Spacer mesh lining provides drier and more comfortable feet
- GEN EX™ rubber lug outsole is slip resistant and non-marking

Black. Sizes: 7-12, 13, 14, 15 in medium and wide widths

6R1-FW594 \$122.00

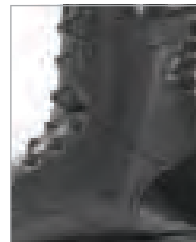

Thorogood™ Trooper Waterproof Side-Zip 8" Boots

Take on the advantage of superior craftsmanship when handling wet weather conditions.

- Bloodborne Pathogen Compliant ASTM-1671
- Waterproof tumbled oiled full-grain leather upper
- GEN-flex dual-density rubber outsole is slip resistant and non-marking
- Lightweight compression molded EVA with impact midsole for comfort
- Double Density Polyurethane removable footbeds with Special Cushion Flex insole
- Goodyear storm welt construction
- Heavy-duty YKK® zipper with VELCRO® brand closure

Black. Sizes: 4-12, 13, 14, 15 in medium width; 7-12, 13, 14, 15 in wide width

6R1-FW674 \$134.00

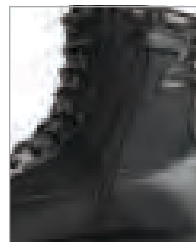

8" Zipper

Bates® DuraShocks 8" Boots

Removable cushioned DuraShocks® insoles dissipate forces before they reach the feet and legs. Watch the video @ galls.com.

- Full-grain leather and ballistic nylon
- Fiberglass shank is security friendly with no metal parts
- Oil and slip-resistant Bates® DuraShocks® Defender with maximum grip 360° lug outsole

Zipper: YKK® side zipper with nylon tab cover; easy on/off

Black. Men's sizes: medium and extra-wide widths in 8-12, 13, 14

6R1-SP675 \$134.95

Waterproof: These boots are made to protect and serve. GORE-TEX® waterproof lining, full-grain leather and ballistic nylon uppers.

- Full-cushioned, removable insole
- Lace-to-toe military styling for easy adjustments and maximum stability

Black. Sizes: Men's 8-12, 13, 14 medium and wide widths; 15 medium width

6R1-SP707 \$159.95

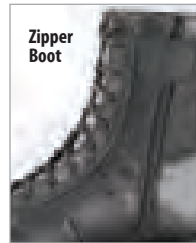

Patrol-Ready Performance



Rocky® Paratrooper Side-Zipper Boots

Increased ankle support plus zipper convenience for easy on and easy off.

- Full-grain leather upper for side zip; leather and lightweight nylon upper for front zip
- Fiberglass shank (side zip); steel shank (front zip)
- EVA (See p. 141) midsole for cushioning
- Oil, gas, slip and abrasion-resistant rubber lug outsole
- Four-part cushioned footbed

Black. Sizes: (7") 8-12, 13, 14 medium and wide widths. (10") 7-12, 13, 14, 15 medium and wide widths

\$142.99

7" **6R1-SP420**

10" **6R1-SP262**

10" Waterproof: Rocky® waterproof system, mesh lining, and 200 grams of insulation.

Black. Sizes: Men's 7-12, 13, 14, 15 medium and wide widths

6R1-SP720 \$162.99



7"



10"

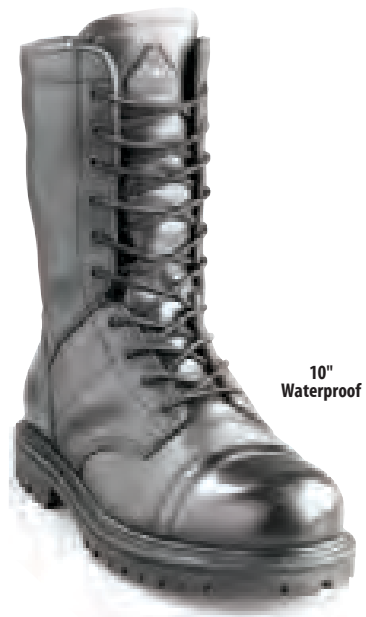

10"
Waterproof



Rocky® Portland 8" Boots

Ultimate lateral support for ankles and shins.

- Full-grain leather and Cordura® nylon construction for performance, durability and strength
- Waterproof
- Lace-to-toe design provides the highest level of lateral support for ankles and shins
- V rubber lug outsole for superior traction, flexibility and support

Black. Sizes: 7-12, 13, 14, 15 in medium and wide widths

6R1-ZM917 \$163.99

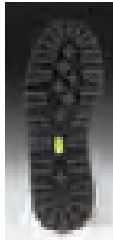

Danner® 8" Acadia GORE-TEX® Duty Boots

Danner's classic construction features detailed stitchdown leather that can be polished for a sharp uniform appearance.

- Waterproof, breathable GORE-TEX® bootie
- Fiberglass shank plus dual density midsole for cushioning
- Perforated built-in cushion insole promotes air circulation to fight bacteria
- Vibram® Kletterlitt outsole gives you a solid footing and can be resoled by manufacturer for a small fee

Black. Made in the USA. Sizes: medium and wide widths in 8-12, 13, 14 and 15

6R1-SP285 \$349.95

Insulated Boots: 200-gram Thinsulate® insulation

6R1-SP597 \$354.95



Danner Cobbler Shop

If your Danner Acadia® boots show signs of wear, Danner will resole and refurbish them (SP285 only). For details, contact Danner at:
877.4DANNER
(877.432.6637).



Heavy-Duty Safety Toe Footwear

**EXCLUSIVE
ITEMS**



tested to work

Mascot® Elbrus Safety Toe Quarter Boots

Built for work with a steel midsole protection and an ergonomic aluminum toe cap for safety and comfort. Anti-slip outsole is heat resistant up to 572°F.

- Buffalo leather construction
- Shock-absorbing comfort sole
- Steel midsole protection
- Slip-resistant polyurethane (PU) rubber outsole is resistant to oil, gasoline and some chemicals
- Heat resistant up to 572°F contact heat
- Water resistant
- Ergonomic aluminum toe cap avoids irritation when bending your foot
- Scuff cap prolongs life of boots
- Bellowed tongue
- Ladder grip features an edge under the sole to prevent slippage on ladders

Black. Sizes: 6-15

6R1-FT484 WAS \$164.79 **NOW \$142.99**

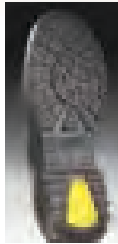

**LOWER
PRICE**

Mascot® Craig Safety Toe Duty Boots

Built with an ergonomic aluminum toe cap for safety and comfort. Anti-slip outsole is heat resistant up to 572°F. Resistant to oil, gasoline and some chemicals.

- Full-grain leather construction
- Shock-absorbing comfort sole
- Thinsulate™ insulation for additional moisture resistance and warmth
- Textile nail protection provides safety and comfort
- Slip-resistant polyurethane (PU) rubber outsole is resistant to oil and some chemicals
- Heat resistant up to 572°F
- Water-repellant upper (WRU)
- Ergonomic aluminum toe cap avoids irritation when bending your foot
- Scuff cap suitable prolongs life of boots
- Bellowed tongue
- Ladder grip features an edge under the sole to prevent slippage on ladders

Black. Sizes: 6-15

6R1-FT483 WAS \$229.99 **NOW \$199.99**



**LOWER
PRICE**





\$29⁹⁹

LawPro

LawPro® Hi-Gloss Dress Oxfords

Look professional at all times with an easy-to-clean, polished surface.

- Hi-Gloss upper
- Perspiration-absorbing lining
- Odor and mildew resistant
- Shock-absorbing outsole

Black. Sizes: Men's 8-12, 13, 14 in medium and wide widths

6R1-FX074 \$29.99



GALLS

Galls® High Gloss Oxfords

A perfect pairing of dress and duty, our High Gloss Oxford supplies the shine you need for parades and other official events.

- Ortholite insole featuring open-cell technology provides comfort that will not diminish over time
- Board-lasted construction for comfort and support
- Airport friendly non-metallic shank for support and fatigue control
- TPR outsole for abrasion resistance

Black. Sizes: Men's medium in 8-12, 13, 14 and 15; wide width in 7-12, 13, 14

6R1-FX072 \$59.99



Thorogood™ Classic Oxfords

Durable, professional and functional.

- Goodyear welt construction
- EVA insole with Poron® heel pad for comfort
- Slip-resistant outsole

Black. Sizes: Men's 4-12, 13, 14 in medium width; 8-12, 13, 14 in wide width

6R1-FW515 \$61.00



Look Your Best

BATES



Bates® High Gloss Duty Oxfords

A professional look with breathable comfort.

- High gloss, Corofram upper
- Breathable mesh lining
- Slip-resistant rubber outsole
- Cement construction

Black. Sizes: Men's medium and wide widths in 7-12, 13, 14; medium width in 15

6R1-FW668 \$69.95

BATES

Bates® Lites High Gloss Oxfords

This oxford meets *Army and Air Force mil-specs*.

- Hi-gloss upper, low-cut straight collar
- Fiberglass shank
- Durashocks® removable, full-cushion insoles with Axidyne Polymer™ for comfort
- Oil and slip-resistant polyurethane outsole
- Breathable Cambrelle® lining wicks away moisture

Black. Sizes: Men's medium and wide widths in 6-12, 13, 14, 15; extra-wide width in 8-11, 12, 13

6R1-SP068 \$129.95



GALLS

Galls® High Gloss 8" Parade Style Boots

Perfect for any dress occasion with all of the features of a comfortable boot.

- Hi Gloss PVC/900D Nylon upper for improved durability and comfort
- PU Foam collar with gusseted tongue
- Removable custom fit EVA insole
- Custom-molded phylon EVA midsole for lightweight comfort
- 5. Texon™ stability platform for support and rigidity
- Nylon shank for superior support
- Classic molded rubber outsole
- Custom-molded thermoplastic heel counter and toe box

Black. Sizes: Men's medium and wide widths in 8-12 and 13, 14

6R1-FX081 \$64.99



With Uniform Footwear



LawPro® Uniform Oxfords

Unbeatable value, incredible comfort and versatility.

- Water resistant
- Smooth synthetic upper offers a professional appearance
- Oil and slip-resistant outsole

Black. Sizes: Men's 3-12, 13, 14 in medium and wide widths

6R1-FX075 \$31.49



\$31.49



Thorogood™ Classic Oxfords

Durable, professional and functional.

- Goodyear welt construction
- EVA insole with Poron® heel pad for comfort
- Slip-resistant outsole

Black. Sizes: Men's 4-12, 13, 14 in medium width; 8-12, 13, 14 in wide width

6R1-FW437 \$66.00



Bates® High Shine Patrol Oxfords

Ideal for the office or the streets, these shoes offer flexible, lightweight construction that requires no break-in.

- Removable full cushioned footbed is breathable and resists odors and mildew
- Breathable mesh lining
- Outsole designed to be light, cool and slip resistant; adds spring to every step

Black. Sizes: Men's medium width in 4-12, 13, 14, 15; extra-wide width in 7-12, 13, 14, 15

6R1-SP863 \$89.95



Rocky® Professional Leather Chukkas

Keep an immaculate appearance without sacrificing quality.

- Full-grain water-resistant leather
- Goodyear welt construction provides added durability
- Pro-Cell insole gives you extra heel cushion
- Rubber outsole for increased traction

Black. Sizes: Men's 7-12, 13, 14 in medium width; 8-12, 13 in wide width

6R1-SP750 \$99.99



Slip-Resistant Stationwear



Dickies® Athletic Slip-On Shoe

Slip into a pair of athletic shoes with superior slip resistance.

- Full-grain polishable leather upper
- Padded collar and tongue
- Fully lined with moisture-wicking performance fabric
- Channeled liquid dispersing outsole designed for slip-resistant performance
- Removable and breathable memory foam insole
- Lightweight EVA midsole; Oil and slip-resistant rubber outsole

Black. Men's sizes: medium width in 7, 8-11, 12, 13, 14

6R1-SP195 \$54.00



Slip Stop



Athletic Lace-Up



Rocky® Men's Oxfords

Slip stop outsole with proprietary tread design provides superior traction and even comes in two styles.

- Leather
- Non-metallic
- Water resistant
- Fiberglass shank

Black. Sizes: medium and wide widths in 8-12, 13 and 14

Description	Item	Price
Athletic Lace-Up	6R1-SP752	\$74.99
Slip Stop	6R1-SP753	\$79.99



Rocky® SlipStop Oxfords

No more slipping and sliding with these oil/slip-resistant outsoles. Perfect for police and security use.

- Slip Stop outsole, rubber siped soles actually channel liquids away from the foot
- Durable, water-resistant leather upper
- Double stitched at the heel and toe for optimum durability
- Unique 4-part cushioned footbed
- Soft and breathable brushed textile inner lining

Black. Sizes: medium and wide widths in 8-12, 13 and 14

6R1-SP138 \$80.99



Slip-on design for fast on and off



5.11 Tactical® Company 2.0 Boots

The 5.11 Company 2.0 boots are a version of the traditional pull on boot that's lightweight, supportive and cushioning. Features 5.11's Quick Call Collar, an innovative, perforated neoprene ankle bootie with outstanding comfort and fit.

- Polishable full-grain leather
- OrthoLite® sockliner
- Full-length phylon comfort platform
- 5.11 kick-off lug
- Stay flat pull tabs
- Oil and slip-resistant outsoles

Black. Sizes: medium width only 5, 6, 6½, 14 and 15; medium and wide widths 7-12 and 13

6R1-FW408 \$119.99

CST Composite Toe Boot: The next evolution in pull-on boot comfort, convenience and performance. ASTM F2413-05 M 1/75 C/75 EH PR Certified.

6R1-FW409 \$139.99

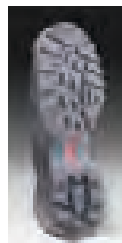

Shop our selection of fire rescue boots starting on p. 252

Casual Style, Tactical Performance

5.11 

Worker Oxford:

- Built on the RECON platform for a natural stride whether walking or on a foot chase
- Full-rubber outsole provides great traction with its integrated fence climbing lugs



Distressed Brown



Dark Coyote



Gunsmoke

Colors: Dark Coyote, Gunsmoke, Distressed Brown

6R1-FT465 \$99.99

Slip-On Shoes:

- Fence climbing lugs
- High density collar ensures heel lock
- Built on a low-profile 8mm drop platform for a natural stride whether walking or on a foot chase



Dark Brown



Dark Coyote

Colors: Dark Coyote, Black, Dark Brown

6R1-FT466 \$99.99+



Visit us online for pricing on additional options.

Lace-Up Shoes:

- High density collar ensures heel lock
- Built on a low-profile 8mm drop platform for a natural stride whether walking or on a foot chase



Black



Dark Coyote



Dark Brown

Colors: Dark Coyote, Dark Brown, Black

6R1-FT467 \$99.99+

5.11 Tactical® Pursuit Footwear

Built to beat the streets while maintaining a level of comfort and business-casual appearance.

- Nubuck and distressed leather upper
- Removable OrthoLite® insoles
- Low-profile CMEVA midsole provides cushion
- Full-rubber tactical outsole
- Accelerated design promotes toe splay
- Professional appearance with running shoe performance
- Supports 5.11 blood-type patch kit #UN744 (available online)

Sizes: 4, 5, 6-12, 13, 14, 15 medium width

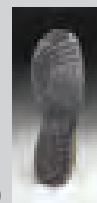

\$99.99



5.11 

5.11 Tactical® Range Master Waterproof Quarterboots

Built for lightweight performance in changing conditions.

- Nylon ripstop and Clarino leather upper
- Ankle height
- OrthoLite® insoles
- Full-length CMEVA midsoles
- eVent® waterproof, breathable, blood-borne pathogen-resistant membrane
- Climbing lugs and broad forefoot for traction and balance
- Low-profile RECON platform with an 8mm heel to toe drop
- HELCOR® leather toe overlays for extreme abrasion resistance
- Includes: 5.11 blood-type patch kit

Sizes: 4, 5, 6-12, 13, 14, 15 medium width

6R1-FT461 \$149.99

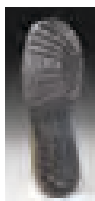

Black

Gunsmoke

Dark Coyote

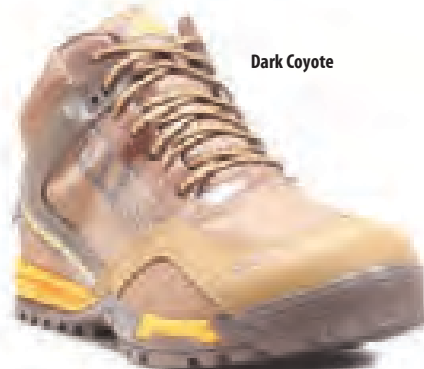

Dark Coyote

Ordering online? Use your PROMOTIONAL CODE from the back cover

800.477.7766 • galls.com

165



Moc
Gunsmoke



Moc
Nubuck
Brown



Moc
Leather
Midnight

Merrell® Men's Jungle Moc

Built with comfort and fit in mind, the Jungle Moc by Merrell is the perfect after-sport moc.

- Strobel construction offers flexibility and comfort
- Lining treated with Aegis® antimicrobial solution
- OrthoLite® anatomical footbed

Colors: Gunsmoke (FT596), Brown (FT594), Midnight (FT595)
 Sizes: 7-12, 13, 14, 15 in medium width; 7-12, 13 in wide width

Description	Item	Price
Moc	6R1-FT596	\$80.00
Moc Nubuck	6R1-FT594	\$95.00
Moc Leather	6R1-FT595	\$100.00

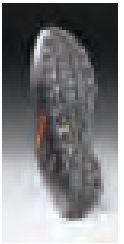

Merrell® Men's Moab Ventilator

A lattice-like overlay of Dura leather strapping supports and protects while enhancing the open-window venting of the breathable mesh upper.

- Dura leather and mesh upper
- Breathable, antimicrobial Aegis® mesh lining resists odor
- Merrell air cushion in the heel absorbs shock and adds stability

Colors: Black Night, Walnut. Sizes: 7-12, 13, 14, 15 medium width; 7-12, 13, 14 wide width

6R1-FT586 \$100.00

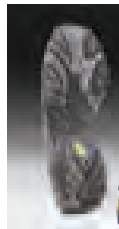

Walnut

Black
Night

Merrell® Men's Moab Waterproof

Explore the wild outdoors with Merrell's Moab Waterproof mid shoes. Waterproof construction with reinforced breathable mesh upper.

- Waterproof Dura leather and mesh upper
- Compression molded EVA (see p. 141) footframe provides cushioning
- Merrell air cushion in the heel absorbs shock and adds stability

Colors: Earth (FT584), Beluga (FT585).

Sizes: 7-12, 13, 14, 15 medium width; 7-12, 13, 14 wide width

Description	Item	Price
Waterproof	6R1-FT585	\$120.00
Mid	6R1-FT584	\$130.00

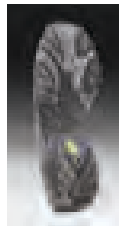

Mid
Earth

Waterproof
Beluga

Merrell® Men's Moab Rover

These waterproof shoes are ready for your outdoor adventures but transition well to urban landscapes.

- Waterproof oiled leather upper with die cut rubber heel for durability
- Merrell air cushion in the heel absorbs shock and adds stability
- Remember Me Foam™ memory foam footbed for comfort

Colors: Black, Espresso. Sizes: Men's 7-12, 13, 14, 15 medium width

Description	Item	Price
Rover	6R1-FT784	\$130.00
Rover Mid	6R1-FT591	\$140.00



Rover
Black

Rover Mid
Espresso

Begin with Merrell®

MERRELL® M

Merrell® Men's Chameleon Prime Stretch

Perfect for fast-paced trail missions, propelled by adaptive, aggressive traction designed to grip whatever conditions the day brings.

- Leather and mesh and synthetic materials upper
- Merrell air cushion in the heel absorbs shock and adds stability
- M Select DRY seals out water and lets moisture escape

Colors: Canteen (FT582), Black, Kangaroo (FT583).

Sizes: 7-12, 13, 14, 15 medium width

Description	Item	Price
Stretch	6R1-FT583	\$110.00
Stretch Waterproof	6R1-FT582	\$130.00

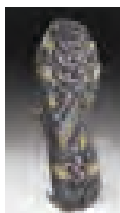

Stretch
Black

Stretch Waterproof
Canteen



Stretch
Kangaroo

Merrell® Men's Traveler Rove

Slip on a pair of Merrell's Traveler Roves. The M-Select MOVE frame provides natural flexibility with support and cushioned comfort.

- Full-grain leather and cow-suede upper
- Breathable mesh lining wicks to keep feet dry
- M-Select FRESH naturally prevents odor before it starts for fresh smelling feet
- M-Select MOVE foot frame gives you an ideal combination of natural flex, contoured support and performance cushioning for all-day comfort

Colors: Black, Canteen. Sizes: 7-12, 13, 14, 15 medium width

6R1-FT593 \$110.00



Canteen

Merrell® Women's Azura Waterproof

These waterproof shoes give you necessary traction on technical terrain with athletic responsiveness and control.

- Waterproof nubuck, suede and mesh upper
- Bellows tongue keeps debris out
- M-Select DRY seals out water and lets moisture escape

Dark Red. Sizes: 5-11 medium width

6R1-FT598 \$120.00

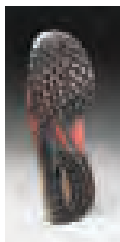

Dark Red

Merrell® All Out Blaze

Responsive, resilient and flexible, the All Out Blaze from Merrell is built to activate your natural form and maximize your effort on the trail.

- Waterproof oily leather and mesh upper
- Molded TPU external heel counter for added stability
- UniFly™ responsive cushioning system

Brown. Sizes: 7-12, 13, 14, 15 in medium width

6R1-FT589 \$130.00

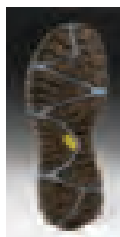

Brown

30-Day Comfort Guarantee

If you are not completely satisfied with your footwear within the first 30 days, send them back for a full refund or exchange. For more details, visit galls.com/footwear.

Elite Performance and Lasting Comfort



Black



Black



Desert Sand



Coyote Brown



Under Armour® Speedfit Hike Mid

Under Armour's Speedfit Hiking shoes are anatomically molded with welded seams and forefoot overlays to hug your feet.

- Synthetic leather construction
- Anatomically molded upper
- Molded tongue for enhanced fit
- Anti-microbial OrthoLite® sockliner
- High traction off-road rubber lug outsole
- Highly water-resistant construction
- Push-thru protection internal stability plate
- TPU toe cap for trail protection
- External heel counter for heel lock down support

Sizes: Men's 8-13, 14 medium width

6R1-FT506 \$129.99



Under Armour® Tabor Ridge Waterproof Low

Tactical utility and athletic performance in a waterproof package.

- Waterproof, windproof, Storm3 ripstop upper
- GORE-TEX® breathable waterproof lining
- Anti-microbial OrthoLite® sockliner with TPU arch support
- Internal stability midsole plate
- Rugged high traction rubber lug outsole
- Molded tongue for enhanced fit, TPU protective boot rand and toe cap
- Quick-pull adjustable speed lacing system

Sizes: 8-13, 14 medium width

6R1-FT505 \$139.99



VISIT US ONLINE

Largest Selection

Discover over 360,000 items from your favorite brands @ galls.com.

30-Day Comfort Guarantee

If you are not completely satisfied with your footwear within the first 30 days, send them back for a full refund or exchange. For more details, visit galls.com/footwear.

Ordering online? Use your **PROMOTIONAL CODE** from the back cover

800.477.7766 • galls.com

169



Salomon XA Pro 3 Forces Boot

From the gym to the field, these adventure boots are famous for their surefooted landings and stable platforms. The low-cut profile, breathable uppers and protective mudguard make these shoes even more lightweight and comfortable for legendary support.

- Anti-debris mesh upper
- Nonreflective materials
- Rubber toe cap
- Friction free lace eyelet
- Sensifit™ cradles the foot from the midsole to the lacing for a customized fit
- Quicklace™ for short prep time and a tailored fit
- Gusseted tongue
- Lace pocket
- Nonmarking Contagrip® outsole for traction in mud or snow
- 3D advanced Chassis™ for agility on mountainous terrain
- Injected, compressed EVA (see p. 141)
- EVA contoured OrthoLite® sock liner

Colors: Black. Sizes: 8-12,13, 14 M

6R1-FT923 \$139.95

GTX Waterproof: GORE-TEX® membrane for wet weather protection. Asymmetrical lacing

6R1-FT932 \$169.95

Mid: Heel foam for extra comfort.

6R1-FT921 \$159.95

Mid GTX Waterproof: Heel foam for extra comfort. GORE-TEX® membrane for wet weather protection

6R1-FT922 \$169.95



Salomon Speedcross 3 Forces Shoe

For aggressive traction when you're blazing the trail, don Salomon's Speedcross Shoes. Whether you're running or training in the mud, snow or rain, the traction and defined fit of these iconic shoes will take you wherever you need to go. Plus, the smart addition of a mudguard reduces the amount of mud and water that would normally splash up on you while you run. Next time you hit the trail, be sure to wear these lightweight and stealthily designed shoes.

- Salomon Speedcross 3 Forces features:
 - Water-resistant textile and anti-debris mesh upper
 - Nonreflective materials
 - Sensifit™ cradles the foot from the midsole to the lacing for a customized fit
 - Quicklace™ for short prep time and a tailored fit
 - Mid feather construction
 - Lace pocket
 - Nonmarking Contagrip® outsole for traction in mud or snow
 - Molded, injected EVA (see p. 141) midsole; lightweight muscle
 - EVA contoured OrthoLite® sock liner

Colors: Black. Sizes: 8-12,13, 14 M

6R1-FT924 \$139.95



Salomon Quest 4D Forces Boot

For a full-mission tactical boot with fast roping capabilities, step into the Forces Boot. Salomon gets to the sole of the matter with superior flexibility and support.

- Anti-debris mesh and Nubuck leather upper
- Nonreflective materials
- Rubber toe and heel cap
- Heel foam
- Closed hooks
- Gusseted tongue
- Nonmarking Contagrip® outsole for traction and lightweight durability
- 4D advanced Chassis™ for agility on mountainous terrain
- Molded EVA (see p. 141) with OrthoLite® sock liner

Colors: Black. Sizes: 8-12,13, 14 M

6R1-FT919 \$219.95

4D GTX Waterproof: GORE-TEX® membrane for wet weather protection. Waterproof bootie. 3D mesh and textile lining

6R1-FT918 \$239.95



VISIT US ONLINE

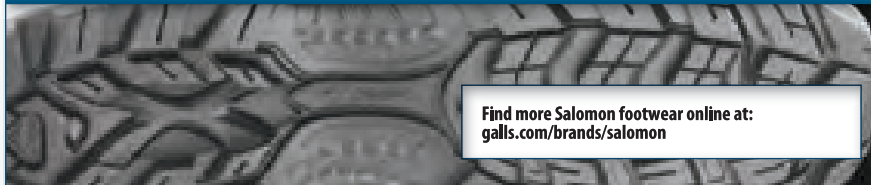

Find more Salomon footwear online at: galls.com/brands/salomon

Built for Tactical Experts



Black



Gunsmoke



Dark Coyote



Storm Gray

5.11

5.11 Tactical® XPRT™ 2.0 Urban Boots

Built to compete with the best European hiking boots. The XPRT 2.0 is a durable and waterproof that can comfortably handle difficult conditions all day.

- HELCOR® leather overlays
- Waterproof nubuck and suede overlays
- Lightweight ripstop nylon
- eVent® waterproof, breathable, BBP resistant membrane
- RECON last
- PU midsole
- XPRT 2.0 outsole
- Padded neoprene ankle collar
- length BI-FIT™ dual hardness insole board
- 5.11 Kick Toe®
- Ghillie Speed lacing with closed loops

Colors: Black, Dark Coyote.

Sizes: Men's 4, 5, 6-12, 13, 14, 15 regular width; 6-12, 13 wide width

6R1-SP078 \$184.99

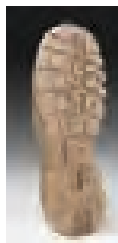

5.11

5.11 Tactical® XPRT™ 2.0 6" Tactical Boots

XPRT 2.0 Tactical Boots combine high-performance materials with top-quality construction.

- Lightweight ripstop nylon with water-resistant HELCOR® leather overlays
- eVent® membrane is waterproof, breathable and BBP resistant
- Full-length BI-FIT™ dual hardness insole board
- XPRT 2.0 outsole
- Soft toe
- Padded neoprene ankle collar
- Ghillie closed loop speed laces

Colors: Gunsmoke, Storm Gray. Sizes: Men's 4, 5, 6-12, 13, 14, 15 regular width; 6-12, 13 wide width

6R1-FT460 \$184.99



5.11 Tactical® XPRT 2.0 Boots

XPRT™ 2.0 Boots combine the best features of high-performance hiking boots with durable functionality of tactical boots. Whether you're climbing boulders, conducting tactical operation, or just relaxing off-duty, you'll stay comfortable and agile.

NEW

Flex Experience RN 5
Cool Gray/Black



In Season TR 5
Black/Gray



Tri Fusion Run 5
Black/Green

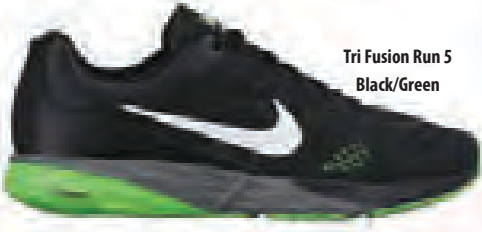

Nike® Men's Flex Experience RN 5

Minimalist design delivers a feather-light feel, yet with the serious gripping action of athletic footwear. Resilient foam midsole generates generous cushioning for landing and propulsion, while waffle outsole pistons absorb impact.



- Resilient foam midsole is durable enough to double as an outsole
- Outsole hexagonal flex grooves promote maximum natural motion
- Waffle outsole pistons help absorb impact and add responsiveness
- Heel-to-toe offset is 7.2mm
- Imported

Colors: Black Anthracite, Cool Gray/Black. Sizes: 6-13, 14, 15

6R1-FX131 \$70.00

Nike® Women's In Season TR 5

Memory-foam sockliner keeps your feet energized, with a lateral midfoot strap for structure and support. Dual-density midsole and strategically positioned outsole pods, enjoy a more natural, efficient stride as you reach your goal.



- Polyester text synthetic plastic
- Internal strap delivers lateral and medial support for multidirectional movement
- Dual-density foam midsole enhances comfort and durability
- Molded collar provides a locked-down fit
- Reinforced TPU overlay on the toe enhances durability
- Rubber outsole pods have a multidirectional traction pattern to increase grip
- Imported

Colors: Black, Gray/White, Navy/Fuchsia. Sizes: 5-11, 12

6R1-FX130 \$75.00

Nike® Men's Tri Fusion Run 5

BLateral midfoot strap and leather overlays lend structure and support for long-distance runs. Tri-density midsole and strategically positioned flex grooves for a smooth transition.

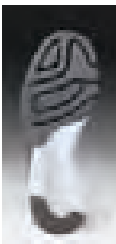

- Tri-density midsole for a soft, smooth transition
- Lateral midfoot strap and leather overlays for structure and support
- Mesh upper for breathability
- Strategically placed anatomical flex grooves for a smooth transition
- Bootie construction wraps the foot for a comfortable glove-like feel
- Solid rubber outsole with diamond pattern for durability and multidirectional traction
- Imported

Colors Black/Green, Black. Sizes: 6-13, 14

6R1-FX132 \$85.00



Cool Gray Black

Nike® Revolution 3 Running Shoe

Revolutionize your workout with Nike's Revolution 3.

- Soft foam midsole
- Rubber outsole
- 4" height

Sizes: 6-13, 14, 15

6R1-FX095 \$60.00



FS Lite Run 3
Black



Blue



Cool Gray



Wolf Gray



Women's FS Run 3
Gray



Ocn Fr Frc



Black



Women's FS Lite Run 3
Black



Cool Gray

Nike® FS Lite Run 3 Running Shoes

Take your training to the next level with the latest evolution of Nike's FS Lite Run series.

- Soft foam midsole
- Rubber outsole
- 4" height

Colors: (FX093) Black, Blue, Cool Gray, Wolf Gray. (FX091) Gray, Ocn Fr Frc, Black. (FX092) Black, Cool Gray. Sizes: (FX093) 6-13, 14, 15. (FX091, FX092) 5-12.5

Description	Item	Price
FS Lite Run 3	6R1-FX093	\$75.00
Women's FS Run 3	6R1-FX091	\$75.00
Women's FS Lite Run 3 Print	6R1-FX092	\$80.00



Next Generation Under Armour® Trainers



UNDER ARMOUR

Under Armour® Chetco Tactical Shoes

Don't let your shoes slow you down when training or running. Take on the track or scale rough terrains with ease and confidence with a pair of tactical shoes that are light, engineered with a cushion system and designed to give you stability in every step.

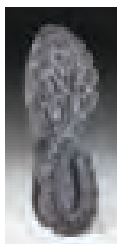

- Storm 1 water-resistant construction (See p. 154)
- Lightweight breathable mesh upper with synthetic overlays provides a supportive and comfortable cradle around the foot
- TPU toe cap for protection
- Anti-microbial Ortholite® sock liner
- Lightweight EVA midsole for optimal cushion
- TPU heel cradle for stability
- High abrasion carbon rubber outsole with aggressive traction

Black. Sizes: 8-12, 13, 14

6R1-FX100 \$84.99



NEW



UNDER ARMOUR

Under Armour® Micro G® Limitless Trainers

Full-length Micro G® foam turns cushioned landings into explosive takeoffs. Added cushioning in the heel and strategic flex grooves in the forefoot work with your natural stride.



- Breathable mesh upper provides the ventilation you need
- Seamless overlays add structure and support without adding bulk
- Adjustable heel lock down strap for improved fit
- Molded 4D Foam® footbed conforms to your foot's exact shape, eliminating slippage
- Full-length Micro G® foam turns cushioned landings into explosive takeoffs
- Added cushioning in the heel and strategic flex grooves in the forefoot work with your natural stride
- Strategically placed rubber traction covers high impact zones for greater durability with less weight
- Offset: 10 mm
- Weight: 8.6 oz.
- Imported

\$84.99

Men's: Colors: Black/Royal, Black/White, Graphite/Black. Sizes: 7.5-13, 14, 15, 16

6R1-FX102

Women's: Colors: Black/White, Graphite/Black, Red/Gray

Sizes: 5-12, 13

6R1-FX103



NEW

Black/Royal



Black/White



Graphite/Black



Red/Gray

Ordering online? Use your **PROMOTIONAL CODE** from the back cover

800.477.7766 • galls.com

173

Versatile, All-Terrain Traction



Nike® SFB Special Field Boots

Gear up for lightweight stability and support. Introducing a stronger midsole design, a leather loop lacing system for a tighter fit and even greater gripping capability in the midst of action.

- Breathable, quick-dry canvas
- Synthetic leather overlays to maintain structure
- Dynamic leather lacing system increases forefoot lockdown and fit
- Phylon midsole offers stability and cushion
- Full rubber outsole for fast roping capability
- Aggressive Nike outsole provides intense traction in both urban and field environments
- Internal rock shield protects against punctures and decreases pressure on the bottom of the foot
- Moisture wicking

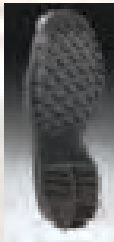

Sizes: 4-12, 13, 14, 15 medium width

Description	Item	Price
6" Black	6R1-SP288	\$130.00
8" Khaki, Coyote	6R1-FT031	\$150.00
8" Black	6R1-SP287	\$150.00



Superior Sole Design and Lacing System

8" Black



6"

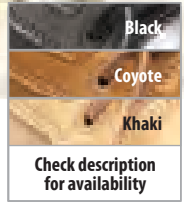

Check description for availability

Nike® SFB 8" Boots

A modern, athletic boot engineered to meet the expectations of world-class heroes. Parts of the forefoot are puncture and laceration resistant, while the midsole is super cushioned and extra flexible. The directional traction outsole offers a better grip when walking and running downhill.

- Quick-drying synthetic leather overlays for durability and support
- Multiple ventilation zones that allow the boot to breathe and drain quickly
- Genuine leather footbed for durability, flexibility and comfort
- A special lock-lace system helps keep your foot in place to maintain a comfortable, customized fit during extended wear
- Nike Free inspired outsole, designed for traction on all terrains

Sizes: 4-13, 14, 15 medium width

6R1-FW601 \$140.00

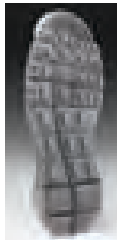

8" Black



Check description for availability

VISIT US ONLINE

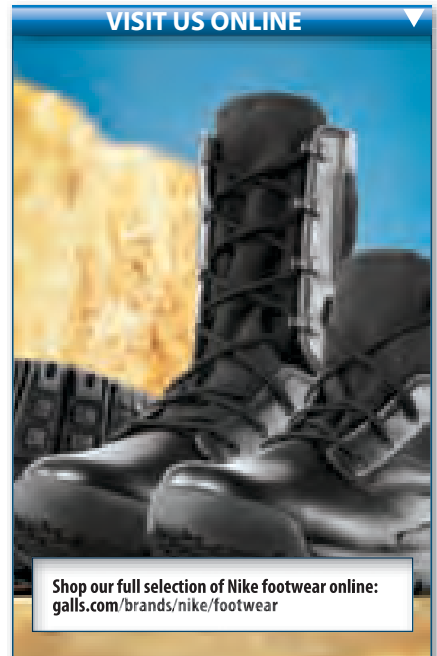

Shop our full selection of Nike footwear online:
galls.com/brands/nike/footwear

Minimalist Athletic Design



TACTICAL RESEARCH

Tactical Research Mini-Mil 8" Duty Boots

A true minimalist boot featuring a 5mm "drop" between the heel and forefoot, the Mini-Mil™ is designed specifically for the conditioned warrior athlete currently training in minimalist athletic footwear.

- Grain-out leather and 1000 denier Cordura® nylon upper
- Compression molded EVA midsole (See p. 141)
- Exclusive Vibram® "Tarsus" oil and slipresistant rubber outsole
- Single density molded EVA Insole

Black. Weight: 21.1 oz.
 Sizes: medium and wide widths in 7-12, 13 and 14

6R1-FW717 \$134.99



Black

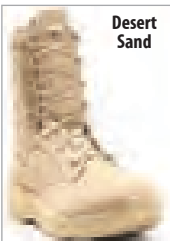

Desert Sand



Real Tree Xtra

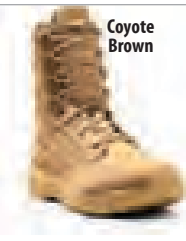

Coyote Brown



Sage



Under Armour® Jungle Rat 8" Boot

Lightweight, minimalist design with quick-draining vents.

- Storm1 water resistant
- DWR (Durable Water Resistant) treated leather and 900D nylon textile upper
- Quick dry, minimalist design with medial side drainage vents
- Antimicrobial OrthoLite® sock liner
- Ultralight Micro G™ midsole with reinforced TPU shank
- Low profile rubber lug sole

Colors: Black, Coyote Brown, Desert Sand, Real Tree Xtra, Sage. Sizes: 8-3, 14 medium

6R1-FT903 \$134.99



DTX Black



Danner
MADE IN U.S.A.

Danner® Tachyon DTX 8" Boots

Lightweight and waterproof with a polishable toe.

- Full-grain leather, 500 denier nylon upper
- GORE-TEX® waterproof membrane
- Open cell PU footbed allows for optimal airflow and durability
- EVA (See p. 141) cushioning and shock-absorbing midsole
- Speed-lace fastening system and durable brass hardware for secure fit
- Slip-resistant rubber outsole featuring pentagonal lugs for superior surface contact

Black. Weight: 21.5 oz. Sizes: regular and wide widths in 3-12, 13, 14, 15, 16

6R1-FT026 \$149.95



Questions?

Our customer service representatives are here to help you Monday-Friday 8:00 a.m. - 9:00 p.m. ET. Call 800.477.7766 today to place an order, ask a question or learn more about our products.

Answer the Call with



8"



Oxford



6"
Side-Zip



Thorogood™ ASR Footwear

Thorogood's Athletic Slip Resisting (ASR) footwear deliver sure footing in any situation

- Athletic, slip-resistant outsole
- High-performance athletic design
- Soft, thick, removable cushioned footbeds
- Attractive polishable leather
- 100% non-metallic

Black. Sizes: 4-5, 13, 14, 15 in medium widths; 6-12, 13, 14, in medium and wide width

Description	Item	Price
Oxford	6R1-FW781	\$72.00
6" Side-Zip	6R1-FW671	\$95.00
8" Side-Zip	6R1-FW839	\$100.00



VISIT US ONLINE

Shop our full assortment of Reebok footwear
online: galls.com/brands/reebok



Under Armour® 8" STELLAR Boot

Ideal for wet environments, Under Armour's STELLAR boot features exclusive Storm I technology for undaunted water-shedding action. Minimalist design makes this boot swift and agile for dynamic operations, with a low-profile rubber lug sole to boot.

- Storm 1 DWR (Durable Water Resistant) treatment (See p. 154)
- Low-profile, minimalist design
- Quick drying
- Polishable toe
- OrthoLite® liner for added comfort
- Reinforced TPU shank
- Molded EVA midsole (see p. 141)
- Rubber lug sole

Black. Sizes: 8-13, 14

6R1-FX099 \$84.99



Slip-Resistant Confidence



8"



Side-Zip



6"



ThoroGood™ Deuce Waterproof Side-Zip Boots

High-performance athletic comfort, ultra-light construction with slip-resistant tread design.

- Full-grain leather and 1200-denier nylon upper provides outstanding strength and durability
- EVA (see p. 141) sole inserts provide shock absorption and cushion
- 2-density rubber outsole delivers traction and extended wear
- 2-zone lining wicks perspiration and circulates air to keep you dry and comfortable

Black. Sizes: 4-5, 13, 14, 15 in medium width; 6-12, 13, 14, in medium and wide width

Description	Item	Price
6"	6R1-SP887	\$94.00
8"	6R1-SP893	\$104.00

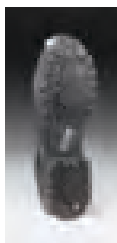

8"



Side-Zip



6"



8"
Coyote



8" Side-Zip
Coyote

Reebok

Reebok® Dauntless Ultra-Light Side-Zip Boots

Forget the weight of traditional duty boots. The Dauntless Ultra-Light boots are ready for all-terrain training and long hours on duty. These boots provide the protection of duty boots with the feel of running shoes.

- Meets ASTM F2892 standards for protective footwear
- Moisture-wicking nylon mesh with AEGIS antimicrobial protection
- Slip and oil-resistant outsole
- 100% non-metallic

Sizes: 6-12, 13, 14, 15 in medium width; 6-12, 13, 14 in wide width

Description	Item	Price
6" (Black)	6R1-FT454	\$96.99
8" (Black)	6R1-FT453	\$104.99
8" (Coyote)	6R1-FX232	\$102.99
8" Side Zip (Coyote)	6R1-FX237	\$109.99



30-Day Comfort Guarantee

If you are not completely satisfied with your footwear within the first 30 days, send them back for a full refund or exchange. For more details, visit galls.com/footwear.

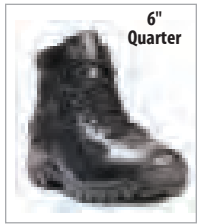
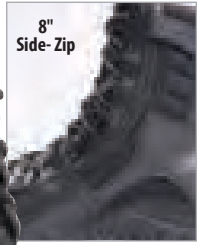

Rocky® C4T 8" Training Boots

Designed for rigorous garrison training in the U.S. Army as an alternative to heavy boots.

- Dual performance material upper
- Polishable toe section
- Water-resistant and fast drying materials
- Ventilation holes on outer sides promote breathability
- Speed lacing system with NATO hooks
- Sturdy 550 grade nylon cord laces
- Lightweight, durable EVA (See p. 141) rubber outsole

Black. Weight: 15 oz. Men's sizes: medium and wide widths in 8-12 and 13

6R1-SP077 \$102.99



Tactical Research Fatt Maxx Duty Boots

Fatt Maxx Duty Boots deliver 24-55% more shock absorbing than other leading athletic tactical boots.

- Rocker midsole geometry encourages smooth gait
- Removable, single-density molded EVA insole
- Ultra cushioning, shock absorbing FATT MAXX midsole
- 100% rubber exclusive vibram ballistic outsole
- Breathable, hydrophilic, spacermesh lining

Black. Sizes: 6-12, 13, 14 in medium and wide width

Description	Item	Price
6"	6R1-FX182	\$119.99
8" Side-Zip	6R1-FX181	\$124.99
8" Waterproof	6R1-FX180	\$139.99



Tactical Research Khyber Tactical Boots

Whether you're standing stationary for hours at a time or performing tactical operations where movement is essential, the Khyber will provide both stability and flexibility in any application.

- Full-grain cowhide leather and nylon fabric upper
- Soft, shock-absorbent EVA (See p. 141) midsole
- Exclusive VIBRAM® "IBEX" outsole for rugged terrain outsole
- TR-1® load-bearing orthotic insole
- Low-profile sole reduces weight and improves mobility
- Air Mesh breathable, moisture-wicking lining

Black. Weight: 26.9 oz; Sizes: medium and wide widths in 3-12, 13 and 14

Description	Item	Price
6" Quarter	6R1-FW715	\$119.99
8" Side-Zip Tactical	6R1-FW713	\$129.99
8" Side-Zip Waterproof	6R1-FW714	\$144.99



VISIT US ONLINE

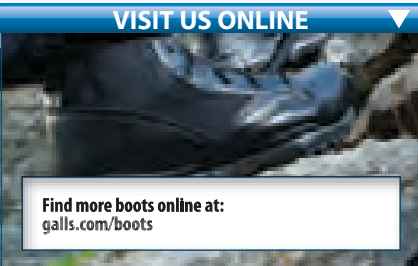

Find more boots online at:
galls.com/boots

Price Match Guarantee

We will match the price of an item found on the Internet for a lesser price and currently for sale by Galls. Some restrictions apply.

We Accept these Major Credit Cards



and Performance

Reebok

8" Zipper Boots

Sure-Grip Plus™ traction makes for one tough outsole.

- YKK® side zipper with leather tab cover; easy on/off
- Fiberglass shank
- Foot Force F2™ Insole System with Shock Eliminator Heel Plug

Black. Men's sizes: medium and wide widths in 8-12, 13 and 14. Women's sizes: medium and wide widths in 5-11

\$119.99

Men's **6R1-FW792**

Women's **6R1-FW789**

Waterproof: Features an athletic fit, feel and performance as well as a shock eliminator pad to reduce heel strike for more comfort.

\$123.99

Men's **6R1-FW793**

Women's **6R1-FW794**

Composite Toe: An incredibly comfortable boot that meets the ASTM-F2413-05 safety toe standards.

\$127.99

Men's **6R1-FW790**

Women's **6R1-FW791**

6" Side-Zip Quarter Boots

Durable boots with the incredible convenience of side-zip.

- YKK® side zipper with leather tab cover; easy on/off.
- Removable Foot Force F2™ Insole System with Shock Eliminator Heel Plug
- Sure-Grip Plus™ traction outsole; the same as used on hiking boots

Regular: Durable nylon/leather upper and nylon mesh, breathable lining.

Black. Men's sizes: medium and wide widths 8-12, 13 and 14

6R1-FW806 \$107.99

Waterproof: The Reebok Starguard Waterproof membrane and 1000-denier nylon uppers build an extremely durable boot.

Black. Men's sizes: medium and wide widths 8-12, 13 and 14

6R1-FW796 \$110.99

Composite Toe: Versatile boots for any profession. Water resistant.

Black. Men's sizes: medium width in 7-12, 13 and 14; wide width in 7-12 and 13.

Women's sizes: 6-12

\$112.99

Men's **6R1-FW797**

Women's **6R1-FW798**

Athletic Assault Oxfords

Removable Foot Force Comfort Insole with arch support and heel stabilizer.

- EVA (See p. 141) midsole
- Non-marking, slip-resistant, high abrasion runner outsole
- Dual density, highly slip-resistant rubber bottom
- Built-in shock eliminator system for a more comfortable step

Black. Men's sizes: medium and wide widths in 8-12, 13, 14 and size 15 in medium only. Women's sizes: medium and wide widths in 6-11

\$89.99

Men's **6R1-FW800**

Women's **6R1-FW801**



8" Waterproof

8" Zipper and Composite Toe



8" Zipper

6" Quarter

6" Zipper



Oxford

30-Day Comfort Guarantee

If you are not completely satisfied with your footwear within the first 30 days, send them back for a full refund or exchange. For more details, visit galls.com/footwear.



Black

Side-Zip

Add a side-zip for only \$5 more

Black

Desert

Check description for availability



Under Armour® Valsetz RTS 7" Boots

A slimmer, athletic cut delivers better mobility by eliminating the bulk of extra fabric.

- Synthetic leather and textile upper
- Ultra-light Micro G™ midsole with TPU shank
- Antimicrobial OrthoLite® sock liner
- Low-profile rubber lug sole
- DWR water-resistant upper
- TPU toe wrap for added protection
- UA ClutchFit™ ankle support system
- Welded, abrasion-resistant polyurethane (PU) film surrounds the foot perimeter

Colors: Black (FT508, FT507), Desert (FT033, FT508).

Sizes: (Black) 8-13, 14 medium and wide widths. (Coyote) 8-13, 14 medium width. Women's 6-10, 11

Description	Item	Price
Men's	6R1-FT033	\$119.99
Women's	6R1-FT508	\$119.99
Men's Side-Zip	6R1-FT507	\$124.99



8" Side-Zip
Black



8"
Coyote



8"
Sage

5.11

5.11® Skyweight 8" Duty Boots

Experience lightweight and abrasion-resistant boot built on a RECON tactical platform.

- Rough-out suede, 1200 denier nylon
- Abrasion resistant for added protection
- OrthoLite® insole adds comfort
- Full-length CMEVA midsole
- Full-rubber outsole; integrated arch lugs for rope and ladder work
- 8 mm heel-to-toe drop provides a low profile and enhanced acceleration
- Nylon shank improves flexibility
- Hook-and-loop location for emergency 5.11 blood type patch (not included)



Duty: Abrasion resistant, tough performance.

Coyote. Weight: 14.7 oz; Sizes: regular width available in 4, 5, 6-12, 13, 14 and 15

6R1-FT024 \$139.99

Side-Zip Duty: Side-zipper for quick on and off.

Weight: 14.7 oz; Sizes: regular width available in 4, 5, 6-12, 13, 14 and 15.

Colors: Black and Sage

\$139.99

Black	6R1-FT016
Sage	6R1-FT025

Performance for Extreme Environments



Bates® Velocitor 6" Quarterboots

Breathable comfort and design.

- Leather/mesh upper
- Breathable mesh lining
- Dual density cushioned insert
- Cushioned EVA (See p. 141) midsole
- Durable rubber outsole with TPU arch support
- Cement construction

Black. 18.6 oz. Men's sizes: medium width in 7-12, 13, 14, 15 and extra-wide width in 7-12, 13, 14

6R1-FW768 \$124.95

Waterproof 6R1-SP208 \$139.95

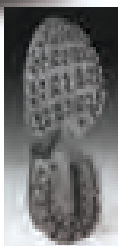

Side-zip convenience



HAI X® Black Eagle 11 Side Zip 8" Duty Boots

These lightweight, non-metallic boots keep you comfortable with the Micro-Dry Haix Climate System.

- Microfiber/textile upper
- Abrasion-resistant and highly breathable inner lining
- HAI X Climate System with Micro-Dry lining at top of leg
- Cushioning, moisture-wicking, anti-bacterial insert
- Anti-slip rubber sole is non-marking, oil and gasoline resistant
- Double Hole Frame/Stone Shield stabilizes the shoe and prevents uneven surfaces from pressing through to the foot
- Permanent cushioning in heel area by EVA (see p. 141) material in the inner sole
- Asymmetrical TPU heel stabilizer
- 2 Zone Lacing System
- Lightweight
- Non-metallic

Black. Sizes: 7-16 medium

6R1-FT034 \$169.99

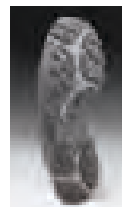

6" Waterproof



Danner® Kinetic 8" Boots

Lightweight comfort and performance.

- Durable, easy-to-polish, full-grain leather and ripstop ballistic nylon
- Multidirectional low lug outsole
- Reinforced heel and metatarsal protection for increased durability

Sizes: Men's 4-12, 13, 14, 15, 16 in medium width and 7-12, 13, 14 in wide width. 6" available in Women's 5-10 medium width

6R1-FW291 \$159.95

GORE-TEX®: 100% waterproof GORE-TEX breathable membrane.

Description	Item	Price
6" Men's	6R1-FW292	\$159.95
6" Women's	6R1-FW701	\$159.95
8" Men's	6R1-FW290	\$169.95



VISIT US ONLINE



Shop our full assortment of Haix footwear online at: galls.com/brands/haix

Ordering online? Use your **PROMOTIONAL CODE** from the back cover

800.477.7766 • galls.com

181

ZIGTECH MIDSOLE

Channels heel impact energy into accelerated propulsion

TPU HEEL STABILIZER

Locked-in stability for all-day support

RUBBER OUTSOLE

Traction and slip resistance with minimal weight

FOOTFUEL FOOTBED

Superior cushioning for dependable and lasting comfort



FUEL YOUR FEET

Reebok
duty

Shock Absorbing Performance



NEW



Athletic Oxford



6" Side-Zip Composite Toe



8" Side-Zip Composite Toe

Reebok

Reebok® ZigKick Side Zip Boots

ZigTech midsole not only provides underfoot comfort but also improves energy return and platform stability. Mesh uppers keep air continually circulating so your feet stay cool and fresh throughout the day.

- ASTM F2892 (ASTM F2892 is the official standard for soft toe protective footwear in the United States)
- Moisture-wicking nylon mesh lining
- 100% non-metallic
- Removable FootFuel™ injected EVA cushion insert
- Vented airflow zone for cooling comfort and arch support, stability and motion control
- ZigTech EVA midsole (see p. 141)
- Rigid TPU heel stabilizer
- Rubber SR outsole



Black. Sizes: Men's 7-12,13,14,15 medium width; 7-12,13,14 wide width; Women's 6-12 medium and wide widths

Description

Athletic Oxford
 6" Men's Side-Zip Composite Toe
 6" Men's Waterproof
 6" Women's Waterproof
 8" Men's
 8" Men's Side-Zip Composite Toe
 8" Women's

Item	Price
6R1-FX226	\$99.99
6R1-FX228	\$119.99
6R1-FX145	\$134.99
6R1-FX146	\$134.99
6R1-FX147	\$124.99
6R1-FX227	\$124.99
6R1-FX148	\$124.99



8"

Ordering online? Use your **PROMOTIONAL CODE** from the back cover

800.477.7766 • galls.com

183



UNDER ARMOUR

Under Armour® Women's HeatGear Solo Linear Socks 3-PK

These moisture-wicking, odor-resistant socks feature built-in arch support for increased comfort.

- 92% Polyester/5% Nylon/3% Spandex
- Flat knit Construction eliminates bulk and conforms to foot
- Embedded Arch Support helps reduce foot fatigue
- ArmourDry material wicks moisture, accelerates evaporation
- ArmourBlock Technology helps prevent growth of odor-causing bacteria

Sizes: Women's M. Colors: Black, White

6R1-FT616 \$14.99 / 3 pk



Under Armour® HeatGear Tactical Boot Socks

Keep your boot-clad feet dry and comfortable.

- 95% polyester, 3% nylon, 2% spandex
- Antimicrobial
- Moisture wicking

Colors: Black, Foliage Green.

Sizes: M (4-8.5), L (9-12.5) XL (13-16). Women's conversion: M (7-10.5), L (11-13)

6R1-FW009 \$9.99



Under Armour® HeatGear Uniform Dress Socks

Under Armour performance for formal occasions.

- 90% olefin/ 7% PolyArmour/ 1% nylon/ 2% spandex
- Advanced cushioning elements provide protection and space compensation
- Sustained arch reinforcement

Black. Sizes: M-XL

6R1-FW348 \$9.99



Under Armour® Hitch Heavy-Cushion Boot Socks

Heavily cushioned for comfort and shock protection.

- 55% acrylic, 30% merino wool, 13% nylon, 2% spandex
- Moisture wicking
- Flex zones bend with foot movement, conforms to foot

Sage. Men's sizes: M (4-8.5), L (9-12.5) XL (13-16). Women's sizes: M (7-10.5), L (11-13)

6R1-FW093 \$16.99



White

Nike® Dri-FIT Socks

Built with sweat-wicking fabric for a dry, comfortable fit, the Nike Dri-FIT Cushion Low Cut Socks (Large/6 Pair) are supportive and cushy, with a minimized silhouette ideal for any athletic endeavor.

- Dri-FIT fabric wicks away sweat to help keep your feet dry and comfortable
- 49% polyester/45% cotton/4% nylon/2% spandex
- Rib cuff for durability and comfort
- Arch support for a secure, snug fit
- Reinforced heel and toe for enhanced durability in high-wear areas
- Cushioned terry foot for comfort and shock absorption
- Machine wash
- Imported

Sizes: S, M, L. Colors: Black, White

\$22.00 / 6 pk

Description	Item
Crew	6R1-FT573
No Show	6R1-FT571
Low Cut	6R1-FT572



Nike® Women's Lightweight No-Show Socks

The Nike Lightweight No-Show Socks (6 Pair) are made with mesh panels and a stretch cotton blend for breathability and a snug, soft feel.

- 70% cotton/27% nylon/3% spandex
- Y-stitch heel pocket for a comfortable fit
- Mesh panels for enhanced ventilation
- Reinforced toe for durability in high-wear area
- Machine wash
- Imported

Multicolor pack.

6R1-FT574 \$20.00 / 6 pk



LawPro®

\$15⁹⁹
3pk

LawPro® Boot Socks

These value-packed socks are easy on your feet and your wallet.

- 75% cotton, 23% nylon and 2% spandex construction
- Cushioned for extra comfort
- Reinforced upper cuff to help keep your sock in place

Black. One size fits 10-13

6R1-FW879 \$15.99/3 pk



Galls® Unisex Athletic Socks

Shadow yarn transports moisture and heat from areas of highest to lowest concentration for a comfortable, thermally balanced sock.

- Arch clincher for fit and comfort
 - Shadow yarn transports moisture and heat
 - Antimicrobial microban fights the growth of odor-causing bacteria
 - Light cushion prevents blistering and enables prolonged performance
- Sizes: S (Women's 4-6), M (Men's 6-8, Women's 7-9), L (Men's 9-11, Women's 10-12), XL (Men's 12-14)

\$15.95

Quarter/3 pk **6R1-FT941**

Crew/2 pk **6R1-FT600**

Low Cut/3 pk **6R1-FT940**

Black



White



Galls® Duty Socks with Padded Toe and Heel

Lightweight with extra padding in the toe and heel for ultimate comfort.

- 11" height
- 60% cotton/20% acrylic/15%nylon/5% spandex
- Tall enough for 10" boots

Black. One size fits 10-13

6R1-SP567 \$8.99



Galls® Cushioned Boot Socks

The perfect socks for everyday wear.

- 88% hi-bulk acrylic/8% stretch nylon/4% elastic
- Wicks moisture to keep feet dry
- Welt top
- Knit-in heel and toe

Black. Sizes M (10"H), L (11"H)

6R1-FW537 \$9.99



Galls® Endurance Boot Socks

Regulates temperature to keep your feet from overheating.

- 13" height
- 82% cotton/10% nylon/5% spandex/3% x-static
- X-Static silver fiber is naturally antimicrobial
- Moisture wicking
- Mesh channels allow enhanced air permeability
- Arch support for better fit and increased circulation

Black. Sizes: M (9-11), L (10-13)

6R1-FW538 \$10.99



5.11® Level I 9" Duty Socks

Built with 12 zones of various compression for improved comfort.

- 80% CoolMax/ 8% nylon/ 8% spandex/ 4% rubber
- Wicking, odor-fighting yarn insole

Colors: Black, Foliage Green, Tan. One size fits most

6R1-SP586 \$12.99



5.11® Summer Socks

Constructed with high-performance fabric for all-day comfort in hot weather.

- 70% polyester, 19% spandex, 8% nylon, 3% rubber
- Moisture wicking
- Engineered compression zones

Black. One size fits most

\$12.99

6" **6R1-SP904**

9" **6R1-SP903**



Pro Feet Extreme Outdoor Boot Socks

Reinforced for ultimate comfort and protection.

- 74% wool, 25% nylon, 1% spandex
- Strategic cushioning
- Venting system for enhanced freshness
- Welted top for stay-up power

Colors: Black, Tan. Sizes: M (size 9-11), L (size 10-13)

6R1-FX060 \$19.99



Tommy Copper™ Athletic Ankle Compression Socks

Infused with high-density activated copper to help relieve muscles, joint stiffness and soreness.

- 30% PRO+IONIC™ copper-nylon, 62% nylon, 8% spandex
- COOL COPPER™ advanced moisture wicking pulls
- Compression fit

Colors: Black, White. Sizes: M, L, XL

6R1-FT468 \$29.50



White

Tommy Copper™ Women's Takeoff Compression Athletic Calf Socks

Infused with high-density activated copper to help relieve muscles, joint stiffness and soreness.

- 30% PRO+IONIC™ copper-nylon, 55% nylon, 15% spandex
- Supportive relief from everyday aches and pains
- Cools and pulls moisture away from the body

Colors: Black, White. Sizes: S, M, L, XL

6R1-FT550 \$49.50



Black

Tommy Copper™ Recovery Compression Dress Socks

Infused with high-density activated copper and featuring 4D stretch compression. Zone Energy System™ increases your mobility and energy during daily activities and vigorous workouts.

- 27% PRO+IONIC™ Copper-Nylon, 65% Nylon, 5% Spandex, 3% Olefin
- Zone Energy System™
- 4D graduated stretch compression
- Cools and pulls moisture away from the body
- Natural anti-bacterial and anti-odor technology

Colors: Black, Charcoal, Midnight Navy. Sizes: S-XL

Description	Item	Price
Jumpstart Crew Socks	6R1-FT548	\$34.50
Jolt Calf Socks	6R1-FT547	\$44.50



Crew

Charcoal

Calf

Midnigh Navy



tested to work

Mascot® Lubango Socks

Warm, breathable and comfortable, this wool-blend boot sock is tough enough to stand up to hard use.

- 43% merino wool, 42% acrylic, 12% polyamide, 3% elastane
- Breathable
- Reinforced heel and toe
- Calf height

Black Anthracite. L-XL

6R1-FT485 \$22.99



Hanz® All-Season Socks (Formerly SealSkinz)



Keep feet dry with Waterproof MVT (Moister Vapor Transpiration). Each sock is individually high-pressure tested to make sure there are no leaks.

- Soft, flexible, stretch-to-fit material suitable for many uses
- Seamless design provides the ultimate action performance and comfort
- Mid-calf sock

Black. Sizes: S-XL

Crew 6R1-FT190 \$38.59

ChillBlocker: Waterproof like Regular Hanz® (formerly SealSkinz socks), insulated for warmth

6R1-FT186 \$56.79



Crew

ChillBlocker

High-Performance Socks



Bates® Tactical Low Cut Uniform Socks

Low-cut style is perfect for athletic oxfords.

- 80% ultraspun polyester, 17% nylon, 3% spandex
- Moisture management wicks away moisture for cooler, drier comfort
- Reinforced toe and heel
- Embedded arch support reduces foot fatigue

Colors: Black, White. Sizes: M, L

6R1-FW779 \$7.95

Bates® Uniform Dress Socks

A traditional uniform sock that's perfect for dress uniforms.

- 80% ultraspun polyester, 17% nylon, 3% spandex
- Moisture management wicks away moisture for cooler, drier comfort
- Reinforced toe and heel
- Embedded arch support reduces foot fatigue

Black. Sizes: M, L

6R1-FW778 \$7.95

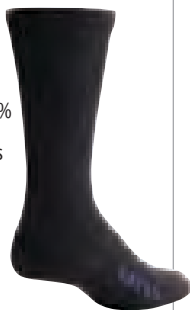

Pro Feet Performance Physical Training Socks

Pro Feet Physical Training Socks provide much-needed relief with an arch reinforcement system for simulated circulation and optimized fit. Antimicrobial fabric actually carries perspiration away from your skin for a cooler, more comfortable workout.

- 97% polyester, 3% spandex
- Moisture wicking
- Antimicrobial
- Arch support zones
- Breathable vent design

Colors: Black, White. Sizes: M (size 9-11), L (size 10-13)

Description	Item	Price
Low-Cut	6R1-FX057	\$11.99 / 6 pk
Quarter	6R1-FX058	\$11.99 / 6 pk
Crew	6R1-FX059	\$12.99 / 6 pk



Pro Feet Performance Silver Tech Low Cut Socks

Athletic low-cut styling.

- 75% polypropylene, 17% nylon, 5% X-Static, 3% Lycra® spandex
- X-Static fiber for natural odor control
- Arch support channels for increased circulation

Sizes: M, L

6R1-FT473 \$8.99

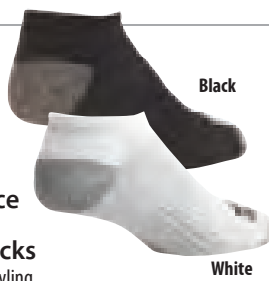

Pro Feet Performance Silver Tech Socks

Pro Feet's unique technology allow your feet to breathe.

- 75% polypropylene, 17% nylon, 5% X-Static, 3% Lycra® spandex
- X-Static fiber for natural odor control
- Arch support channels for increased circulation

Black. Sizes: S-L

Description	Item	Price
Crew	6R1-FT474	\$9.99
Over-The-Calf	6R1-FT475	\$10.99



Pro Feet Hero Series SOCKS

Your feet deserve all the support you can give them, especially when you're on a special assignment that requires extended hours on your feet. That's where Pro Feet Socks can provide much-needed relief with an arch reinforcement system for simulated circulation and optimized fit.

- Moisture wicking, breathable vent design
- Antimicrobial
- Arch support zones for anti-foot fatigue

Sizes: M (Women's 6-9; Men's - 4½-8½) L (Women's 9-12; Men's 8½-12)

"Solidarity" Quarter Socks: 65% polypropylene, 15% spandex, 12% nylon, 8% stacool polyester. Black, White

6R1-FX085 \$7.99

"Never Forget" Crew Socks: 65% polypropylene, 15% spandex, 6% nylon, 8% stacool polyester, 6% endurall. Black

6R1-FX082 \$8.99

"Remembrance" Crew Socks: 65% polypropylene, 15% spandex, 12% nylon, 8% stacool polyester. Black

6R1-FX083 \$8.99

"Action" Crew Socks: 65% polypropylene, 15% spandex, 12% nylon, 8% stacool polyester. White

6R1-FX084 \$8.99

"Salute" Boot Socks: 65% polypropylene, 15% spandex, 12% nylon, 8% stacool polyester. Black

6R1-FX086 \$9.99



Solidarity



Never Forget

Remembrance

Action

Salute

Support the Families of Fallen Officers

Each year, between 140 and 160 officers are killed in the line of duty and their families and co-workers are left to cope with the tragic loss. C.O.P.S. (Concerns of Police Survivors) provides resources to help them rebuild their shattered lives. Members include spouses, children, parents, siblings, significant others, and affected co-workers of officers killed in the line of duty.

Streamlight® Duty-Ready,

A
260 Lumens

B
615 Lumens

C
500 Lumens



Streamlight® Strion® Rechargeable C4 LED Flashlights

Compact STRION® C4 LED and HP offers optimized electronics for regulated intensity. Each features a single, multi-function tail switch for one-handed operation. *ANSI/NEMA FL1-2009 compliant. IPX4 rated for water resistance.*

A) Tradition: Unbreakable BOROFLOAT® high temperature glass lens. Machined aircraft aluminum body with anodized finish. Up to 7½ hrs run time. Produces 260 lumens. 5¾" L. 5.2 oz

Item	DC	AC	AD (AC & DC)
6R1-FL858	\$100.99	\$105.99	\$105.99

Flashlight Only (battery included) **6R1-FL857 \$97.39**

B) HPL: This HPL (high performance, high lumens) light features a deep-dish parabolic reflector to produce a long range targeting beam with optimal peripheral illumination. Produces 615 lumens. 7" L. 7.1 oz

Item	DC	AC	AD (AC & DC)
6R1-FL899	\$116.19	\$121.99	\$131.29

Flashlight Only (battery included) **6R1-FL898 \$112.39**

C) High Lumen: This HL (high lumen) light provides up to 200 meters of beam distance. Produces 500 lumens. 6" L. 5.25 oz.

Item	DC	AC	AD (AC & DC)
6R1-FH307	\$121.29	\$131.39	\$146.49

We Accept these Major Credit Cards



Streamlight Beam Patterns

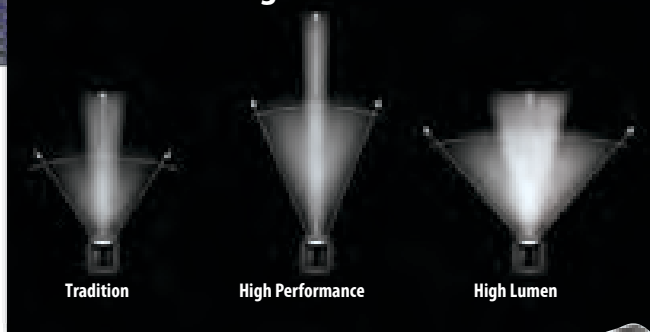

Streamlight® UltraStinger® LED Rechargeable Flashlight with Charger

Features the latest LED technology to produce a powerful 1,100 lumen beam with superior down-range performance — lights up objects as far away as 510 meters!

- 6000 series machined aircraft aluminum with non-slip rubberized comfort grip
- IPX4 water resistant, 3 meter impact-resistance tested
- 1,100 lumens high (1½ hrs. run time), 350 lumens medium (4½ hrs. run time), 90 lumens low (16 hrs. run time)

Black. 11¾" L. 9.9 oz

Item	DC	AC	AD (AC & DC)
6R1-FL293	\$134.99	\$144.99	\$159.99

Rechargeable Flashlights



Streamlight® Stinger C4 LED Rechargeable Flashlights

The Stinger Series gives you the flexibility of choosing the light that is right for you, whether you prefer a single or dual switch. Each offers a different balance of features that are ideal for a variety of applications.

A) Tradition: Rechargeable flashlight with C4 LED technology and 50,000 hours of life. The Streamlight Stinger LED takes one of our best-selling flashlights – the Rechargeable Stinger – and makes it even brighter with C4 LED technology. Produces 350 lumens.

FL622 & FL623 8½"L. 12.4 oz. **FL652, FL653 & FL651** 8¾"L. 12.8 oz

Item	Switch	DC	AC	AD (AC & DC)
6R1-FL622	Single	\$100.99	\$106.99	\$110.99
6R1-FL652	Dual	\$105.99	\$116.19	\$129.39
6R1-FL653	Fast Charge	\$131.39	\$136.39	\$156.69

Single Switch Flashlight Only (battery included) **6R1-FL623 \$93.79**

Dual Switch Flashlight Only (battery included) **6R1-FL651 \$97.89**

B) HPL: The HPL (high performance, high lumens) C4 LED is two-three times brighter than a high flux LED. Multi-function on/off push-button gives access to any of the three variable lighting modes and strobe on the head-mounted switch. Produces 740 lumens.

FL891 & FL890 9¼"L. 13.6 oz. **FL893 & FL892** 9¾"L. 14 oz

Item	Switch	DC	AC	AD (AC & DC)
6R1-FL891	Single	\$121.29	\$126.29	\$131.39
6R1-FL893	Dual	\$121.29	\$126.29	\$136.39

Single Switch Flashlight Only (battery included) **6R1-FL890 \$117.69**

Dual Switch Flashlight Only (battery included) **6R1-FL892 \$115.49**

C) High Lumen: The HL (high lumen) features a multi-function on/off push-button switch for three lighting modes and strobe. Produces 640 lumens.

FH305 & FH478 8½"L. 12.4 oz. **FH306 & FH479** 8¾"L. 12.8 oz

Item	Switch	DC	AC	AD (AC & DC)
6R1-FH305	Single	\$111.19	\$116.19	\$131.39
6R1-FH306	Dual	\$127.29	\$136.39	\$147.49

Single Switch Flashlight Only (battery included) **6R1-FH478 \$98.79**

Double Switch Flashlight Only (battery included) **6R1-FH479 \$105.99**

Streamlight Stinger Charging Sleeve **6R1-FL039 \$21.39**

Battery Stick **6R1-FL126 \$20.39**

Wand **6R1-FL217 \$7.19**

No Hassle Guarantee

See p. 98

Flashlight FAQs

Light Output (Lumens): Indicates the total light generated without regard to direction, beam quality or configuration.

Beam Distance (Meters): A measure of how far away the flashlight will usefully light an object when the beam is optimally focused.

Peak Beam Intensity (Candela): Indicates the light intensity in the brightest part of the beam when optimally focused.

Run Time (Hours/Minutes): The duration that a flashlight will continuously operate.

VISIT US ONLINE

There's more online! Shop our complete assortment of flashlights at: galls.com/flashlights

SL-20X
200 Lumens



SL-20XP
150 Lumens

Charging System Puts Your Flashlight on Automatic

The charging system for the SL-20XP and SL20X automatically shuts off if the flashlight is accidentally left on, then turns on when you take it out of the charger. If left in the charger, it automatically turns on, during a power outage.

Streamlight® Rechargeable Lights

Streamlight Rechargeable Lights have the incandescent brightness and extended run time of the LED, creating a flashlight you can depend on in any circumstance. These lights are water-resistant and built with an unbreakable, scratch-resistant polycarbonate lens.

SL-20XP: is a lightweight, full-sized rechargeable that combines the brightness of an incandescent with the extended run time of LEDs — the best of both worlds.

- ANSI/NEMA FL1-2009 compliant
- Nylon polymer body with non-slip rubber grip
- Halogen bulb provides 28,000 candela peak beam intensity/150 lumens
- Run time: 40 hours (LED)
- Bulb life: 100,000 hours (LED), 100 hours (halogen)

13" L. 16 oz. Colors: FL655 Black, Black/Yellow trim, Black/Orange trim; FL411 Black, Black/Orange trim

Item	DC	AC	AD (AC & DC)
6R1-FL411	\$102.99	\$108.19	\$113.39

SL-20XP Rechargeable Light (battery included) **6R1-FL655 \$102.99**

Battery Stick **6R1-FL172 \$41.59**

Lamp Module **6R1-FL413 \$20.99**

SL-20X: model is a full-size professional grade rechargeable with a 40 hour LED run time and 80 minute halogen run time.

- ANSI/NEMA FL1-2009 compliant
- Machine aircraft aluminum body
- Halogen bulb provides 38,000 candela peak beam intensity/200 lumens
- Run time: 40 hours (LED) and 1½ hours (halogen)
- Bulb life: 100,000 hours (LED), 100 hours (halogen)

Black. 13" L. 25 oz

Item	DC	AC	AD (AC & DC)
6R1-FL538	\$113.39	\$123.79	\$133.99

SL-20X Rechargeable Light (battery included) **6R1-FL537 \$103.99**

SL-20L with Charger: is a full-size, full-feature aluminum flashlight with C4 LED technology that delivers a 490 meter beam!

- Deep-dish parabolic reflector produces a tight beam with optimum peripheral illumination
- Illumination output: 350 lumens (high), 160 lumens (medium), 10 lumens (low)
- Run time: 2 hour run time (high), 4 hours (medium), 50 hours (low), 4 hours (strobe)
- NiCd battery rechargeable up to 1,000 times; fully recharges in 7 hours

Black. 13" L. 28 oz

Item	DC	AC	AD (AC & DC)
6R1-FH155	\$116.19	\$126.29	\$136.39

Streamlight® Road Safety Kit

Includes SL-20XP LED Flashlight with AD charger (FL411: \$113.39) and a red traffic safety wand (FL098: \$8.19).



6R1-FL396 \$127.49

Streamlight® Accessories

Description	Item	Price
Chargers (fit all Stingers)		
Charger	6R1-FL039	\$21.39
AC or DC Charge Cord	6R1-FL051	\$20.79
Five Unit Charger	6R1-FL315	\$311.99
Charge Sleeve for SLX Series	6R1-FL595	\$13.39
Stinger LED Flashlight Holders		
Nylon Holder	6R1-NP573	\$24.79
Leather Holder with Flap	6R1-LP595	\$36.39
Leather Open Top Holder	6R1-LP596	\$33.29
Traffic Wands		
Red or Yellow fits Stinger® XT, LED	6R1-FL217	\$7.29
Hi-Vis fits Stinger®, XT, LED	6R1-FL567	\$13.39
Red or Yellow fits Stinger® HP, XTHP, Ultra	6R1-FL325	\$8.29
Hi-Vis fits Stinger® HP, XTHP, Ultra	6R1-FL566	\$11.79
Red or Yellow fits SL20X, SL20X LED, SL20XP	6R1-FL098	\$8.19
Hi-Vis fits SL20X, SL20X LED, SL20XP LED	6R1-FL565	\$13.89
Lenses		
Red Flip Lens fits Stinger®, XT, LED	6R1-FL101	\$16.49
IR Lens fits Stinger®, XT, Poly	6R1-FL283	\$30.89

VISIT US ONLINE

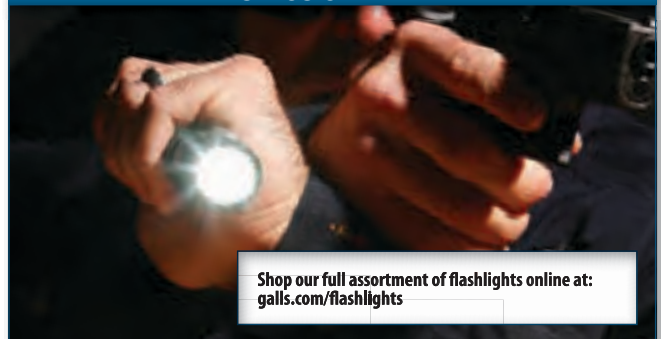

Shop our full assortment of flashlights online at:
galls.com/flashlights

Rechargeable Duty Lights



Fenix Rechargeable Flashlights

Rechargeable convenience with multiple output levels to choose from. Turbo mode produces extreme illumination. Fenix UC45 features an integrated Micro USB charging port cover, eliminating annoying rubber charging port covers. Both lights feature:

- Durable Aircraft grade aluminum
- Cree XM-L2 U2 LED
- Digitally regulated output maintains constant brightness
- Toughened ultra-clear glass lens with anti-reflective coating
- Tactical tail switch with momentary-on function
- Waterproof

Description	Lumens (low/mid/high/turbo/strobe)	Length/Weight	Item	Price
UC45	10/100/375/960/960	7"/13 oz	6R1-FL092	\$120.69
UC50	10/150/415/900/900	7"/8 oz	6R1-FL090	\$128.39

UC50
900 Lumens



UC45
960 Lumens



Nightstick® 9614 Dual Switch Lithium-Ion Battery AD

Rechargeable aircraft-grade aluminum LED flashlights with 3 microprocessor-controlled brightness modes as well as a strobe function.

- Constant flashlight and strobe or momentary
- 4.15 hours (high) 350 lumens; 8.5 hours (medium) 200 lumens; 32.5 hours (low) 55 lumens; 5.5 hours (strobe) 350 lumens
- Approximately 4 hours charge time

9"L. 12.8 oz (with battery). Includes rechargeable lithium-ion battery pack, charging platform, AC charger, DC charging cord

6R1-FH262 \$99.95

9614
350 Lumens



9924
650 Lumens

Nightstick® 9924 Duty/Personal Dual Rechargeable Flashlight

A multi-function dual light allows you to use a flashlight and floodlight at the same time to search and illuminate your path.

- Beam distance up to 275 meters on high while an unfocused floodlight is directed down for safety
- Flashlight Illumination Output: 650 lumens (high), 300 lumens (medium), 100 lumens (low)
- Floodlight Illumination Output: 600 lumens

9½"L. 9.9 oz (with battery). Includes: rechargeable lithium-ion battery, charger, AC & DC power supply and anti-roll ring

6R1-FH878 \$129.99



Fenix RC15 Rechargeable Flashlight

As durable as it is versatile, this compact light features four power levels to handle everything from extreme lumens to extreme runtime.

- Aircraft-grade aluminum construction with, type III hard-anodized anti-abrasive finish
- 4 power levels: 860 lumens, 1 hr. 10 min. run time (turbo), 350 lumens, 3 hr. run time (high), 130 lumens, 6 hr. 30 min. run time (mid), 9 lumens, 100 hr. run time (low)
- IPX-8 standard, waterproof to 6.5 feet/2 meters for 30 minutes

6½"L. 8.4 oz (with battery). Includes built-in 2600mAh 3.7V rechargeable lithium battery AC and DC adaptor, charging cradle, holster, lanyard, spare "O" ring.

6R1-FH666 \$149.79



860 Lumens

Pelican™ 7060 LED Flashlight with AC Charger

The Pelican 7060 LED flashlight comes with a versatile dual-switch technology that allows activation from either body-mounted patrol or tail-mounted tactical switch. Lightweight and shock-resistant, it also comes with a rechargeable 2200mAh lithium ion battery.

- 175 lumens/14,000 lux value at 1 meter
- 1 ½ hours continuous burn time after 4-5 hours of recharge time
- 4.4W LED, optimized beam, serrated lens shroud
- Grenade grip for firm handling and easy activation control
- Included: 3.7V lithium ion battery and AC charger

8½"L. 10.4 oz (with battery); 8.2 oz (without battery)

6R1-FL933 \$188.69

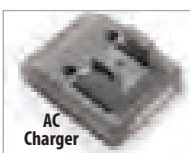

AC
Charger



175 Lumens

Compact, Rechargeable Lighting

Galls® 800 Lumens Rechargeable Tactical Flashlight

Tactical metal flashlight with rechargeable CREE® LED technology. A multifunctional tail switch alternates between high, medium, low and strobe modes.

6¼"L. 6.1 oz

6R1-FH800 \$106.59

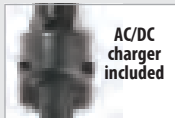

AC/DC charger included



Push Button Tail Switch

\$104⁹⁹



800 Lumens



Streamlight® ProTac HL USB-Rechargeable Light

The ultimate in versatility, this USB-rechargeable high lumen tactical flashlight uses most USB sources as well as several battery sources, so you need never be without light.

- 6000 series machined aircraft aluminum with anodized finish
- IPX4 water resistant; 1 meter impact resistance tested
- High: 850 Lumens (lasts 1.5 hours)
- Medium: 350 Lumens (lasts 4 hours)
- Low: 85 Lumens (lasts 12 hours)
- Strobe for disorienting or signaling: lasts 1.5 hours

6½"L. 7.2 oz. Lithium ion rechargeable battery (included). Also accepts two CR123A batteries or one 18650 battery.

6R1-FL399 \$109.99

ProTac HL USB AC/DC **6R1-FL391 \$119.99**



Charge from any USB source



Multifunctional Tactical Tail Switch



850 Lumens

ASP® Triad USB Light

A top-of-the-line tactical flashlight with multiple charging options. As any ASP product, it provides superior performance designed to suit the needs of law enforcement professionals and those seeking the finest, brightest, most advanced lighting tools.

- Made of aluminum; anodized in a matte black hard coat
- Durable foamed vinyl grip
- CREE® XPG R5 LED
- 300 lumens; 1.5 hr run time
- 3 position ILC switch (intermittent/lock/constant)
- O-ring sealed for water resistance
- 18650 lithium ion battery; battery safety circuit
- AC/wall charger, DC/car charger, micro USB retractable cord (all included)
- Zippered nylon travel accessory pouch (included)

5½"L

6R1-FH127 \$129.49

ASP Triad Rotating Case/Holster **6R1-FH129 \$23.29**



300 Lumens

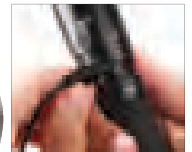

Micro USB port for charging on-the-go



Rotating Holster

5.11®

5.11® TMT and ATAC Rechargeable Flashlights

Tactical utility with rechargeable convenience. Built with intelligent mode cycling technology for quick selection between high, low or strobe modes.

- Impact-resistant aerospace grade aluminum
- Cree XP-GB
- High, low and strobe modes

6"L. Includes lithium ion rechargeable battery, battery pack, battery cartridge, 120V/12V charging station, breakaway lanyard

Description	Lumens (high/strobe)	Run-Time Hrs. (high/low)	Item	Price
R1	339/23	3/74	6R1-FL056	\$138.99
R3MC	357/20	3¼/87	6R1-FL059	\$158.99



TMT R1
357 Lumens

ATAC R3MC
339 Lumens

Rechargeable Backup Lights

Fenix UC40UE Rechargeable Flashlight

Features the latest CREE XM-L2 U2 LED, large capacity 3400mAh rechargeable battery and max 960-lumen output. Positive side switching on the head means total control.

- Durable Aircraft grade aluminum construction
- Cree XM-L2 U2 LED
- Turbo: 960 lumens (90 minutes)
- High: 400 lumens (225 minutes)
- Mid: 110 lumens (16 hours)
- Low: 10 lumens (150 hours)
- Strobe: 960 lumens
- Tri-fuel capable: USB charging/18650 Li-ion cell or two CR123A batteries
- Side switch in the head for fast and convenient operation
- IPx8 waterproof

5¾"L. 8 oz (with battery). 3400mAh /3.6V rechargeable Li-ion battery

6R1-FL099 \$91.99



960 Lumens

COAST® HP5R Rechargeable Flashlight

The HP5R rechargeable flashlight has a beam distance of up to 172 meters, making it an excellent duty light for all types of tactical, rescue and law enforcement professionals.

- 185 lumens (high), 19 lumens (low)
- Tail cap switch
- 4.5 hrs run time (high), 14 hrs run time (low)
- Operates with a lithium polymer rechargeable battery or 1 AA alkaline battery

4¾"L. ¾"Dia. 2.6 oz. Includes: 2 lithium polymer rechargeable batteries, 1 AA alkaline battery, USB charging cord, AC and DC adapters, sheath, belt clip and wall mount

6R1-FH678 \$95.99



185 Lumens



201 Lumens

COAST® HP7R Rechargeable Flashlight

Projects a beam of light up to 1,003 feet. Maintains a superior beam consistency from spot to flood without any dark rings.

- 201 lumens (high), 22 lumens (low)
- 7.75 hrs run time (high), 38 hr run time (low)
- Quick cycle switch on tail cap
- Flex Charge Dual Power system charges with AC, DC or USB adapter
- Uses 1 li-ion rechargeable battery pack or 1 alkaline battery cartridge with 4 AAA batteries

5½"L. 1"Dia. 7.2 oz. Includes: 2 lithium ion rechargeable batteries, alkaline battery cartridge with 4 AAA batteries, USB charging cord, AC and DC adapters, sheath, belt clip and wall mount

6R1-FH679 \$96.39



Includes USB charger, AC and DC adapters



Maglite® MAGTAC™ LED Rechargeable Flashlights

An advanced lighting tool engineered for long service life with a 2.5 hr. charge time. The charging base can be powered by the included 12V adapter or 120V converter, or by any other charging source that complies with the USB 2.0 Standard.

- Precision machined, hard anodized aluminum
- Water resistant
- Impact resistant up to 2 meters
- Multi mode electronic switch
- 543 lumens (high), 112 lumens (power save)
- Rechargeable high capacity Lithium Iron Phosphate (LiFePO4)

5¾". 5.5 oz. Includes MAG-TAC® Rechargeable Flashlight with Lithium Iron Phosphate (LiFePO4) battery, battery tool, mountable charging base - USB powered, mounting screw, pocket clip, pocket clip tool, USB cable, 120V adapter, 12V adapter

Description	Item	Price
Non-Scalloped Bezel	6R1-FL332	\$121.79
Scalloped Bezel	6R1-FL331	\$131.99



Non-Scalloped

543 Lumens

Scalloped

Trust MagLite® for Rugged Reliability

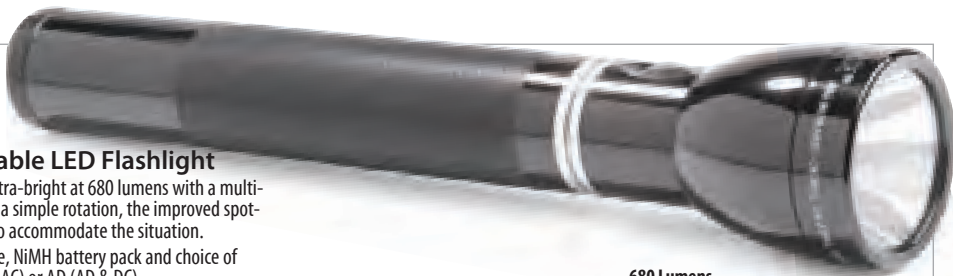

680 Lumens

MagLite® Mag Charger Rechargeable LED Flashlight

The MagLite Mag Charger Rechargeable LED Light is ultra-bright at 680 lumens with a multi-mode switch to allow interchangeable functions. With a simple rotation, the improved spot-to-flood system quickly focuses or expands the beam to accommodate the situation.

12 $\frac{1}{2}$ " L, 32 oz (with batteries). Includes: charging cradle, NiMH battery pack and choice of direct wire seup (DW), 12V cigar plug (DC), 110V plug (AC) or AD (AD & DC)

Item	DW	DC	AC	AD (AC & DC)
6R1-FH845	\$139.79	\$144.99	\$150.19	\$155.29

Rubber Switch Cover	6R1-FL057	\$3.29
Replacement Glass Lens	6R1-FL081	\$11.49
Battery Stick for Mag Charger	6R1-FL314	\$25.99

MagLite® Non-Rechargeable MagLites

Legendary MagLite durability, plus advanced lighting features.

FL585 features an ultra-bright LED module in place of the Krypton® bulbs in halogen models (FL062). All models ship with a spare bulb or LED module in the tailcap.

- ANSI/NEMA FL1-2009 compliant
- Virtually indestructible aircraft aluminum body; anodized for corrosion resistance
- Patented spot-to-flood beam; Krypton® bulb is 300% brighter than ordinary bulbs
- Rotating head allows for beam focusing
- Sealed self-cleaning switch and knurled grip
- Water-resistant o-ring seals; shock-resistant lens



C-Cell
8 $\frac{1}{2}$ "

D-Cell
10"

Cell Size	Length	Weight (oz)	CP	Batteries Required	Item	Price
C-Cell	8 $\frac{1}{2}$ "	15.7	8,200	2	6R1-FL062	\$26.99
C-Cell	10 $\frac{1}{16}$ "	19.1	13,500	3	6R1-FL062	\$27.99
C-Cell	12 $\frac{3}{8}$ "	22.5	14,000	4	6R1-FL062	\$28.99
D-Cell	10"	23.8	9,000	2	6R1-FL069	\$29.59
D-Cell	12 $\frac{3}{16}$ "	30	14,000	3	6R1-FL069	\$30.69
D-Cell	14 $\frac{3}{4}$ "	36.8	15,700	4	6R1-FL069	\$31.69
D-Cell	17 $\frac{1}{4}$ "	43.5	17,000	5	6R1-FL069	\$35.79
D-Cell	19 $\frac{5}{8}$ "	50	20,500	6	6R1-FL069	\$42.89
D-Cell LED	10"	23.8	9,000	2	6R1-FL585	\$38.59
D-Cell LED	12"	30	14,000	3	6R1-FL585	\$38.59

Rubber Switch Cover	6R1-FL057	\$3.29
Replacement Lens	6R1-FL202	\$7.69
C-Cell Batteries	6R1-FH208	\$6.99/2 pk
D-Cell Batteries	6R1-FH209	\$7.99/2 pk
Replacement Bulb	6R1-BU055	\$3.29



Maglite® ML300LX™ LED Flashlight

Whether you're using a flashlight for work or play, the Maglite® ML300LX™ LED Flashlight is the light for all your needs.

- Anodized aluminum construction
- Water resistant
- Impact resistant up to 1 meter
- Multi mode electronic switch
- Full power: 2D (524 lumens, 6 $\frac{1}{2}$ hrs. run time), 3D (625 lumens, 16 hrs. run time)
- Low power: (130 Lumens, 20 hrs. run time), 3D (143 lumens, 77 hrs. run time)
- Eco mode: (58 lumens, 69 hrs. run time), 3D (58 lumens, 117 hrs. run time)

9" (2D), 11 $\frac{3}{4}$ " (3D). 20 oz with batteries (2D), 26.4 oz with batteries (3D)

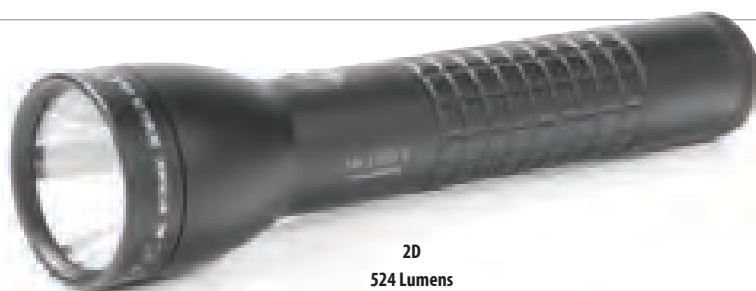

2D
524 Lumens

Item	2D	3D
6R1-FL330	\$58.89	\$60.89

High-Tech Options for Duty and for Tactical Operations

D3
1231 Lumens

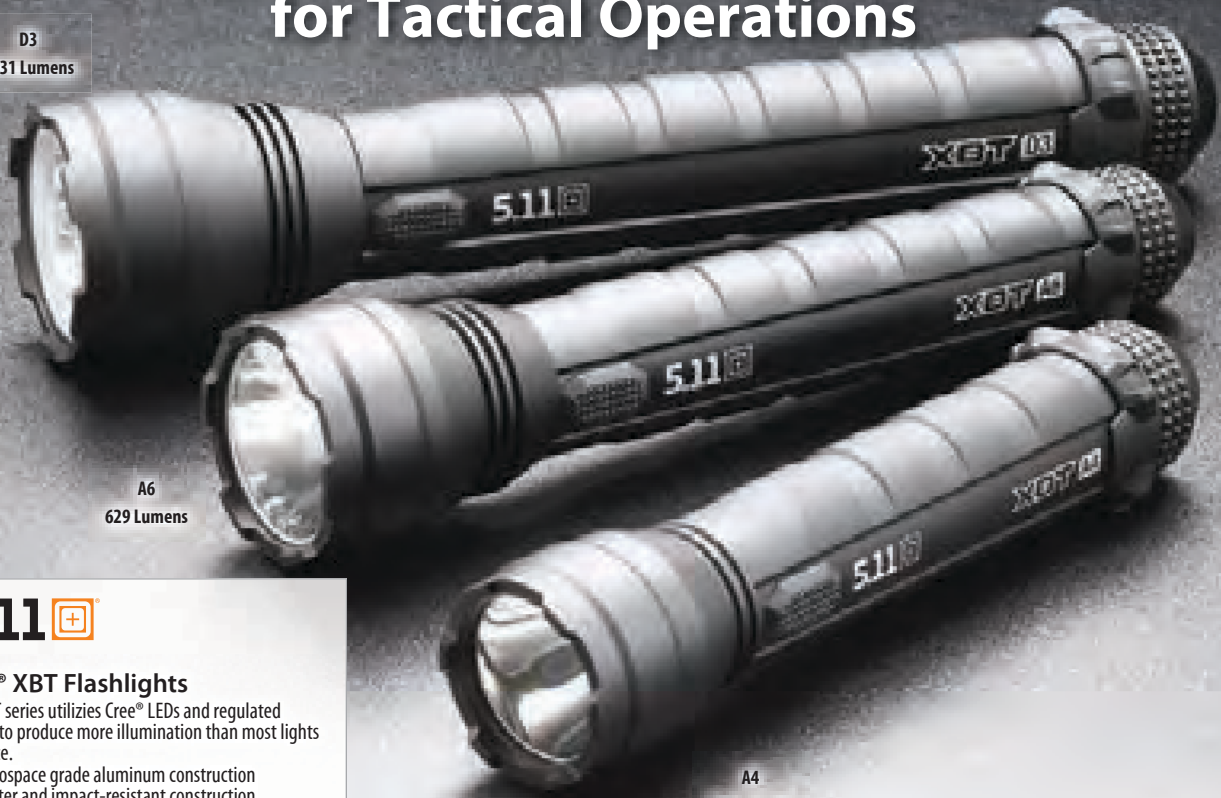

A6
629 Lumens

A4
355 Lumens



5.11® XBT Flashlights

The XBT series utilizes Cree® LEDs and regulated circuits to produce more illumination than most lights their size.

- Aerospace grade aluminum construction
- Water and impact-resistant construction
- Momentary and constant-on modes
- Regulated circuit for maximum output

D3:

- Three Cree® XMLB LEDs
- 1231 lumen output (High)/100 lumen output (low)
- 2 hour run time (high)/72 hours (low)
- 188 meter beam distance (high)
- Crenellated bezel
- Anti-roll rubber design
- Powered by three D-cell batteries (sold separately)

12"L, 2½" Dia. 32 oz with batteries

6R1-FL076 \$138.99

D-Cell Batteries **6R1-FH209 \$7.99/2 pk**

A6:

- Cree® XMLB LED
- 629 lumen output (high)/111 lumen output (low)
- 328 meter beam distance (high)
- 10 hour run time (high)/57.5 hours (low)
- Powered by 6 AA batteries (included)

10"L, 2" Dia. 16 oz with batteries

6R1-FL074 \$94.49

AA Batteries **6R1-FH207 \$4.99/2 pk**

A4:

- Cree® XP-E LEDs
- 355 lumen output; 2.5 hour run time
- 279 meter beam distance
- Shoulder switch
- Anti-roll design
- Operates on 4 AA batteries (included)

8½"L, 1¾" Dia. 11 oz with batteries

6R1-FL065 \$62.39

AA Batteries **6R1-FH207 \$4.99/2 pk**



MagLite® MAG TAC Flashlights

Multiple options with "Quick Click" access.

- Two styles: scalloped bezel or non-scalloped bezel
- Powerful CREE LED
- Lumens: 320+
- Run time: 4.5 hours
- Bezeled version has 3 modes: momentary, on and strobe
- Non-bezeled version has 3 modes: momentary, on, low

5¼"L. 4.8 oz (with battery). Includes: 2 CR123A lithium batteries

Description

	Item	Price
Non-Scalloped Bezel	6R1-FH399	\$81.49
Scalloped Bezel	6R1-FH199	\$88.29

CR123 Batteries **6R1-FH211 \$19.99/6 pk**

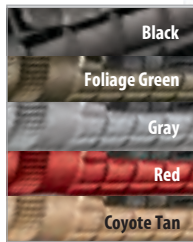

Non-Scalloped Bezel



320+ Lumens



Scalloped Bezel

Tactical Tools from Your Favorite Brands



110 Lumens

\$36⁷⁹



Galls® Handheld LED Tactical Flashlight

This compact flashlight features high quality construction and performance at an affordable price! Perfect for tactical or everyday use.

- Made of aircraft-grade aluminum
- Shock resistant
- Weather resistant
- High powered CREE® LED (100,000 hr LED life)
- 110 lumens; up to 3 hr run time

6"L. Uses 2 AA batteries (sold separately). Includes nylon holster

6R1-FH122 \$36.79

AA Batteries **6R1-FH207 \$4.99/2 pk**

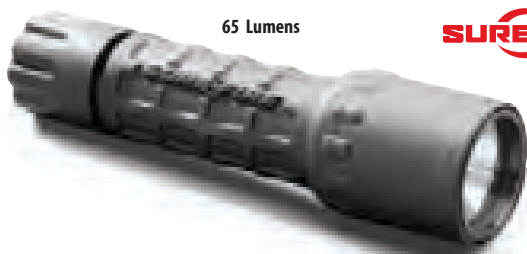
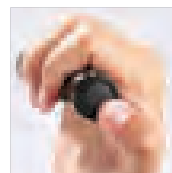

65 Lumens



SureFire® G2 Nitrolon Flashlight

SureFire G2 Nitrolon produces a smooth, brilliant, pre-focused tactical-level beam which means you get a solid ring of light — no dark spots or circles.

- Weatherproof, corrosion-proof polymer body
- 65 lumens with a one-hour continuous run time
- Momentary on/constant on
- Lockout tail cap switch prevents accidental activation

Black. 5"L. 4 oz. Includes: 2, CR123 lithium batteries

6R1-FL563 \$55.79

CR123 Batteries **6R1-FH211 \$19.99/6 pk**



200 Lumens



SureFire® G2X LED Flashlight

Provides the longevity needed when out in the field.

- Nitrolon polymer body
- Weatherproof
- 200 lumen output
- Run time: 2½ hours (high), 45 hours (low)
- Momentary/constant on options
- Lockout tail cap

5¼"L. 4.4 oz. Includes: 2, CR123 lithium batteries

6R1-FL957 \$63.00

CR123 Batteries **6R1-FH211 \$19.99/6 pk**



500 Lumens



Surefire® P2X Fury

The P2X Fury uses a high-efficiency, virtually failure-proof LED to deliver your choice of either 15 or 500 lumens of perfectly focused light — the latter qualifying the Fury as a pocket-sized searchlight!

- High-strength, Mil-Spec hard-anodized aerospace aluminum body for extreme durability
- Tough, impact-resistant polycarbonate window; weatherproof O-ring and gasket sealed
- Virtually indestructible LED emitter regulated to maximize light output and run time
- Precision micro-textured reflector creates smooth, optimized beam
- Output: High (500 lumens, 1½ hr run time), low (15 lumens, 46 hr run time)
- Dual-output tail cap click switch for momentary/constant on in low or high mode
- Tail cap switch locks out to prevent activation during transport or storage

5¾"L. 5.7 oz. Includes: 2, CR123 lithium batteries

6R1-FH168 \$139.50

CR123 Batteries **6R1-FH211 \$19.99/6 pk**



Momentary On Switch

Streamlight® ProTac HL 3 Tactical Light

Produces 1100 lumens to provide extraordinary brightness for an entire area.

- Meets ANSI/NEMA FL1-2009 standards; Meets IPX7 waterproof standard up to 1 meter for 30 minutes; Impact resistance tested up to 1 meter
- Anodized aircraft aluminum construction with anti-roll head
- Push-button tail switch; TEN-TAP® programmable switch
- Illumination output: 1100 lumens (high), 35 lumens (low) strobe
- Run time: 1½ hours (high), 36 hours (low), 1½ hours (strobe)

7⅞" L. 9.3 oz (with batteries). Includes 3, CR123A lithium batteries, nylon holster and pocket clip

6R1-FH844 \$92.69

CR123 Batteries **6R1-FH211 \$19.99/6 pk**



Streamlight® ProTac Lights

Tiny personal carry lights that pack a punch in brightness.

- IPX7-rated for water resistance up to 1 meter for 30 minutes
- Impact-resistant tempered glass lens
- Push-button operation for high, low or strobe modes
- Anti-roll head prevents the light from rolling away when you set it down

1AAA

- Illumination output: 70 lumens (high) and 5 lumens (low)
- Run time: 30 minutes (high), 1 hours (low) and 1.2 hours (strobe)
- Includes: 1 AAA alkaline battery and removable pocket clip

4" L. 1.3 oz (with batteries)

6R1-FL390 \$27.99

AAA Batteries **6R1-FH206 \$4.99/2 pk**

1AA

- 70 lumens for up to 1¾ hours (high), 6 lumens for 22 hours (Low) and 4 hours of Strobe runtime
- Includes: 1 AA alkaline battery, nylon holster and removable pocket clip

4" L. 2¾ oz (with battery)

6R1-FL913 \$41.19

AA Batteries **6R1-FH207 \$4.99/2 pk**

2AA

- Illumination output: 155 lumens (high) and 14 lumens (low)
- Run time: 1¾ hours (high), 21 hours (low) and 4 hours (strobe)
- Includes: 2 AA alkaline batteries, nylon holster and removable pocket clip

6" L. 4.1 oz (with batteries)

6R1-FL925 \$45.49

AA Batteries **6R1-FH207 \$4.99/2 pk**

HL

- Illumination output: 750 lumens (high), 35 lumens (low)
- Run time: 1¾ hours (high), 18 hours (low)
- Includes: removable pocket clip and 2 CR123A lithium batteries

5¼" L. 5.5 oz (with batteries)

6R1-FH159 \$68.69

CR123 Batteries **6R1-FH211 \$19.99/6 pk**

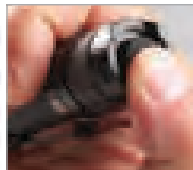

Fenix TK15 LED Flashlight Tactical Grip

With 400 lumens in Turbo mode, the Fenix TK15 is designed to throw a beam up to 705 ft. When switched on, the Fenix TK15 turns on in the last brightness level selected.

- Made of durable aircraft-grade aluminum with premium Type III hard-anodized anti-abrasive finish
- Anti-roll, slip-resistant body design
- 5 output modes: Turbo, High, Med, Low, Strobe
- Produces up to 400 lumens with run time of 2.25 hours (up to 100 hours on low)
- Tactical tail cap switch with momentary-on function

5¾" L. 4.4 oz (with battery). Includes: 2, CR123 lithium batteries

6R1-FH368 \$74.95

CR123 Batteries **6R1-FH211 \$19.99/6 pk**

Fenix PD35 Tactical Flashlight

The lightweight and portable PD35 takes you from work to weekend adventures.

- IPX8 waterproof up to 2 m
- Aircraft-grade anodized aluminum
- CREE XM-L2 LED provides 850 lumens (turbo), 450 lumens (high), 170 lumens (medium), 45 lumens (low), 10 lumens (eco)
- Run time is 1.3 hours (turbo), 2.5 hours (high), 7.8 hours (medium), 29 hours (low), 140 hours (eco)
- Rear tail cap includes momentary switch and side for easy mode selection

5½" L. 3.1 oz. Requires 2 CR123 lithium batteries (sold separately).

6R1-FH687 \$71.95

CR123 Batteries **6R1-FH211 \$19.99/6 pk**

Innovative Lighting Solutions

First-Light USA® T-MAX LE Tactical Flashlight

Built for superior hand control, the T-MAX allows you to access to the entire control panel with just your thumb. Ergonomically designed to give you maximum use of your hand while still maintaining control of the light.

- Aerospace grade aluminum construction
- Waterproof
- 7-- lumens
- Powered by 2 CR123 batteries (included)

2½"L x 1½"W x 3½"H. 5.9 oz

6R1-FL113 \$279.99



FIRST-LIGHT
USA

First-Light USA® T-MAX LE Kit with Belt TRS

Easily holster or un-holster the tactical light on your duty belt with the TRS Belt Mount. The clip rotates 180° allowing the light to pivot while holstered.

6R1-FL112 \$299.99

Energizer 3V Lithium Batteries **6R1-FH211 \$19.99/6pk**

First-Light USA® Torq LE Tactical Flashlight

Ergonomically designed to give you maximum use of your hand while still maintaining control of the light.

- Constructed from durable, proprietary polymers
- 155 lumens maximum output
- 10 hour runtime
- Waterproof (1 meter)
- Powered by 2 AA batteries (included)

2¾"L x 1¼"W x 3¾"H. 5.7 oz

6R1-FL104 \$109.99

AA Batteries **6R1-FH207 \$4.99/2 pk**



GALLS



Galls® 200 Lumens LED Tactical Light

Delivers 200 lumens of light with standard AAA batteries. Includes red and yellow traffic wand tips.

- 200 lumens on high, 80 lumens on low
- Aluminum construction for durability
- Multifunctional switch
- 1.5 hrs runtime high, 3 hrs runtime low
- Operates on 3 AAA batteries (sold separately)

6½"L. 12 oz. Includes red and yellow traffic wand tips, lanyard and holster

6R1-FL222 \$39.99

AAA Batteries **6R1-FH206 \$4.99/2 pk**



VISIT US ONLINE

Shop our complete selection of tactical lights online at:
galls.com/tactical-flashlights



Fenix PD32 LED Flashlight

Impact and waterproof resistant aircraft aluminum construction.

- Max 340 lumen output from 2 CR123A batteries (included)
- Six outputs including strobe and SOS
- Side controls and tail cap momentary switch
- Includes spare o-ring, spare rubber boot, lanyard, body clip, sheath and batteries

5"L. 2.2 oz

6R1-FH376 \$61.95

Energizer 3V Lithium Batteries **6R1-FH211 \$19.99/6pk**

FENIX



Fenix TK35 LED Flashlight

Convenient high-intensity and multi-functional with durable aluminum construction.

- Cree® XM-L LED produces an amazing 900 lumens with almost 2 hours of runtime
- 900 lumens (turbo), 375 lumens (high), 125 lumens (medium), 15 lumens (low)
- Digitally regulated output maintains constant brightness
- Uses 4 CR123A batteries (included)

6½"L. 9 oz

6R1-FH367 \$99.95

900 Lumens



Fenix E35UE Tactical Flashlight

Fenix CREE LEDs packs a powerful 900 lumen burst mode for extreme illumination. A broad beam system provides brighter and broader coverage with three normal-use output levels to choose from.

- IPx8 waterproof rating
- Durable aircraft-grade aluminum
- 4 modes including burst, high, mid and low
- Maximum beam distance: 512 feet/156 meters
- Intelligent memory circuit automatically enters the previous used brightness level
- Powered by one rechargeable Li-ion battery or two 3V-CR123A lithium batteries

Black. 5"L. 4 oz

6R1-FL093 \$48.99

Energizer 3V Lithium Batteries **6R1-FH211 \$19.99/6pk**



A1
130 Lumens

A2
220 Lumens

L1
212 Lumens

L2
320 Lumens

5.11® TMT A1/A2 Tactical Flashlights

5.11 TMT A1 and A2 deliver the best in CREE® XP-E LED performance with high, low, strobe and momentary on modes.

Includes: AA batteries (1 for A1 and 2 for A2) and breakaway lanyard

Desc	Lumens (hi, low)	Run-Time Hrs. (hi, low)	Length	Weight (oz)	Item	Price
A1	130, 15	7, 11	4¼"	3.1	6R1-FH572	\$51.99
A2	220, 12	1½, 57	6"	4.9	6R1-FH573	\$59.99
AA Batteries 6R1-FH207 \$4.99/2 pk						

5.11® TMT L1/L2 Tactical Flashlights

5.11 TMT tactical flashlights are a favorite among public safety professionals with a CREE® XP-G LED output plus high, low, strobe and momentary on modes.

Includes: CR123A lithium batteries (1 for L1 and 2 for L2) and breakaway lanyard

Desc	Lumens (hi, low, strobe)	Run-Time Hrs. (hi, low, strobe)	Length	Weight	Item	Price
L1	212, 16, 212	2, 24½, 3¼	4"	2.6	6R1-FH574	\$69.99
L2	212, 16, 212	2½, 54½, 77	5¼"	3.8	6R1-FH575	\$79.99
CR123A Batteries 6R1-FH211 \$19.99/6 pk						

5.11® TMT LX Tactical Flashlights

Adding to the 5.11 TMT Series with even greater illumination.



Desc	Lumens (hi, low)	Run-Time Hrs. (hi, low)	Length	Weight	Item	Price
L2X	600, 50	2½, 50	6"	6.2	6R1-FH695	\$99.99
L3X	750, 50	2½, 50	7½"	8.1	6R1-FH696	\$119.99
CR123A Batteries 6R1-FH211 \$19.99/6 pk						



Smith & Wesson® Galaxy Elite CREE LED Flashlight

The Galaxy Elite features Constant Current Circuitry for uniform brightness throughout battery lifetime.

- Constructed of precision 6061 anodized aluminum for superior corrosion resistance
- 200 Lumens; 3-hour run time
- Waterproof, moisture, fire resistant and shatterproof
- Polycarbonate lens is water, scratch and impact resistant
- Tactical tailcap switch and pocket clip

5"L. 10.4 oz. Includes: nylon holster and 2 AA batteries

6R1-FH113 \$45.89

AA Batteries **6R1-FH207** \$4.99/2 pk



200 Lumens

Weapon-Mounted Lighting

NEW

SUREFIRE.



200 Lumens

SureFire® XC1 Ultra Compact LED Handgun Light

XC1 is truly a game-changer with its small size and ultra-light weight. Engineered to equip compact railed handguns with white light, this weapon light is a necessity for CCW applications. XC1's tough yet sophisticated build is precision machined from robust, lightweight aerospace aluminum. A hard-anodized finish that meets stringent military standards adds even more protection.

- Lightweight aerospace aluminum construction
 - Gasket sealed; weatherproof
 - Broad, smooth MaxVision Beam™ for close-quarter applications
 - High-performance LED generates 200 lumens of tactical-level light
 - 1.5 hours run time
 - Integrated ambidextrous momentary and constant-on switching
 - Easily and securely attaches to most universal rail equipped handguns
- Black. 2³/₈" L. 1.6 oz. Uses one AAA lithium battery (included)

6R1-FL424 \$289.99



TLR-1
300 Lumens



TLR-2
300 Lumens



Streamlight® TLR-1 and TLR-2 LED

These lightweight gun-mounted tactical lights feature the latest in shockproof LED technology for reliable operation. Intensely bright, virtually indestructible rail-mounted tactical light, mounts to almost any gun in seconds.

- Machined aluminum with black anodized finish
- 300 lumens, 2.5 hour run time
- Solid-state current regulation for consistent illumination
- C4 LED technology is impervious to shock
- Deep-dish parabolic reflector produces a concentrated beam with optimum peripheral illumination
- IPX7 rated design; waterproof to 1 meter for 30 minutes
- Mounts directly to handguns with Glock-style rails and to all MIL-STD1913 (Picatinny) rails with no tools
- Ambidextrous momentary/steady on/off switch

3¹/₄" L. 4.2 oz. Powered by 2 3-volt (CR123) lithium batteries (sold separately)

TLR-1
without strobe **6R1-FL571 \$106.99**
with strobe **6R1-FL896 \$121.19**

TLR-1 HPL
with strobe **6R1-FH163 \$179.89**

TLR-2 (has a red laser light attached)
without strobe **6R1-FL572 \$283.49**
with strobe **6R1-FL897 \$272.99**

CR123 Lithium Batteries **6R1-FH211 \$19.99/6 pk**



TLR-1 HPL
775 Lumens



TLR-1 HL

630 Lumens



TLR-2 HL with Red Laser Sight



Streamlight® TLR HL Tactical Gun Mounts

Intensely bright, virtually indestructible rail-mounted tactical light, attaches to almost any gun in seconds. Provides a 630 lumen blast of light for maximum illumination while clearing a room or alley. This lightweight gun-mounted tactical light features the latest in shockproof LED technology for reliable operation. Rail clamp designed to rapidly attach or detach from side of weapon. Tethered battery door and latch mechanism prevents battery door loss while providing easy battery replacement.

- Machined aluminum sealed construction with black anodized finish
- 630 lumens, 1.25 hour run time
- Solid-state current regulation for consistent illumination level
- C4 LED technology, impervious to shock with 50,000 hour lifetime
- Deep-dish parabolic reflector produces a concentrated beam with optimum peripheral illumination
- IPX7 rated design; waterproof to 1 meter for 30 minutes
- Rail grip clamp system securely attaches/detaches quickly and safely with no tools and without putting your hands in front of muzzle
- Mounts directly to handguns with Glock-style rails and to all MIL-STD1913 (Picatinny) rails
- Ambidextrous momentary/steady on/off switch
- Highly accurate sight repeatability when remounting
- Fits existing light bearing holsters

3³/₈" L. 4.8 oz. Uses two CR123 lithium batteries (sold separately)

Desc.	Item	Price
TLR-1 HL	6R1-FH308	\$131.39
TLR-2 HL with Laser Sight	6R1-FH309	\$335.99
CR123 Lithium Batteries	6R1-FH211	\$19.99/6 pk



125 Lumens

Streamlight® TLR-4 Compact Weapon Light with Laser Sight

Fits compact and sub-compact handguns and produces a concentrated LED beam with optimum peripheral illumination.

- IPX4 water resistant; serialized for positive identification
- Impact-resistant engineering polymer with durable anodized aluminum facecap
- C4® LED technology with 5,000 candela peak beam

intensity; 125 lumens

- 640-660nm red laser provides long range targeting; features fine adjustment screw
- 1.5 hr run time on LED plus Laser; 11 hrs on laser only (3V lithium battery included)
- Ambidextrous momentary/steady on-off switch
- 3 position selector: LED/laser/both

2⁵/₈" L. 2.75 oz. Key kit included for mounting to many weapons (not included in H&K USP models)

6R1-FH164 \$149.79

CR123 Lithium Batteries **6R1-FH211 \$19.99/6 pk**

Illumination Accessories and Upgrades



QuikLite Pro Clip LED Light

Hands-free 100% lapel-concealed led light that fits into your uniform pocket.

- Water resistant aluminum housing
- 10-minute battery saving auto-off, independent LED lens activation and safety strobe provides 50+ hours of continual light
- 180° adjustable clear LED lens and adjustable arm to set lighting angles
- 360° rotating QuikClip
- Instant-on/off switch
- Includes: 2 CR2032 batteries

3 7/8" H x 1" W x 1 1/8" D. 2 oz

6R1-FL971

Ultra Violet and White

\$24.95
\$26.95



QuikLite X Rechargeable Clip Light

World's smallest, brightest USB rechargeable, hands-free concealed LED light source for your uniform shirt pocket!

- Dual CREE LEDs
- 20 to 150 lumens (white LEDs) and 5 modes
- 20 to 75 lumens (blue/red LEDs) and 4 modes
- Independent LED activation, safety strobe, 10 minute auto-off timer
- 180° adjustable light arm; 360° rotating removable clip
- Includes: micro USB charging port and charging cord, magnetic clip and USB rechargeable lithium battery

3" H x 7/8" W x 1" D. 1.4 oz

6R1-FH150

Ultra Violet and White

\$39.95
\$46.95



TerraLUX®

Terralux® MiniStar LED Conversion Kits

Ultimate LED performance upgrade for your MagLite or Streamlight flashlights.

- Extends battery run time and lifetime
- Electronically regulated for constant light output
- **FH257:** fits MagLite MiniMag flashlights
- **FH258:** fits MagLite 4-6 cell flashlights
- **FH259:** fits MagLite MagCharger flashlights
- **FH260:** fits Streamlight, Stinger, Stinger XT and PolyStinger flashlights with 3.6V rechargeable batteries only
- **FH261:** fits Streamlight SL20X and SL20X LED flashlights. Not for use with Streamlight SL20XP
- Not recommended for use with lithium batteries (may shorten LED life)

Description	Lumens (hi/med/low)	Run time (hrs) (hi/med/low)	Item	Price
MiniStar2 Extreme	140	4	6R1-FH257	\$26.79
MiniStar5® 6EX	140	up to 33	6R1-FH258	\$26.29
MiniStar31 MR-EX®	1000/500/100	2/6/37	6R1-FH259	\$105.99
MiniStar ST/EX	300	up to 2	6R1-FH260	\$68.39
MiniStar 110S	600	1 1/2	6R1-FH261	\$85.29

Rechargeable Flashlight Batteries

Enjoy the long-term savings of using rechargeable flashlight batteries.

Fits	Item	Price
A) Survivor® Alkaline Pack	6R1-FL600	\$5.39
B) SL-20XP™	6R1-FL010	\$29.99
C) STRION™	6R1-FL439	\$38.59
D) All Stingers®	6R1-FL126	\$20.69
E) SL-20X LED™	6R1-FL583	\$47.99
F) UltraStinger® SL-20XP LED	6R1-FL172	\$42.29
G) Fire Vulcan™	6R1-FL526	\$43.99
H) Original Survivor®	6R1-FL017	\$55.89
I) Div. 2 Survivor®	6R1-FL304	\$53.29



Rechargeable Battery Stick

Rechargeable battery stick for SL-20X and MagCharger.

- NiCad 6V battery with 2.4 amps
- Rechargeable up to 1,000 times
- 1 1/2 hours of continuous use between charges

6R1-FL314 \$25.99



Pocket-Sized

MAGLITE



14
Lumens

Mini MagLite® Flashlight

Adjustable spot-to-flood beam lets you switch from sharp focus to a broader flood light pattern.

- Aircraft aluminum construction
- 2,200 candle power for 5¼ hrs
- Spare bulb in the tailcap
- Uses 2 AA batteries (included)

Black. 5¾"L. 3¾ oz. Limited lifetime warranty.

6R1-FL063 \$16.69

AA Batteries **6R1-FH207 \$4.99/2 pk**

5.11 



90 Lumens

5.11® TMT PLx Pen Light

Durable pen light designed for easy portability.

- Aerospace grade aluminum
- Cree® XPG-B LED
- Illumination output: 90 lumens (high)
- Run time: 4 hrs (high)
- Beam distance: 40 meters (high)

5"L. 2.2 oz (with batteries). Includes 2 AAA batteries

6R1-FH571 \$26.99

AAA batteries **6R1-FH206 \$4.99/2 pk**

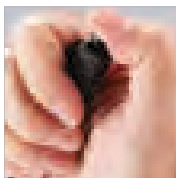

NIGHTSTICK
Life Depends on Light™



Mini-TAC
140 Lumens



Mini-TAC Gooseneck
140 Lumens

Nightstick® Mini-TAC Flashlights

The Nightstick Mini-TACs are perfect backup lights. A deep parabolic reflector creates a tight, long throw beam for distance illumination.

- Meets ANSI IP-X4 standards for water resistance
- 2 meter drop rating for impact resistance
- Aircraft grade 6061-T6 aluminum construction with type 2 hard anodized finish
- Momentary or constant-on tail cap switch
- Cree® LED technology – 50,000+ hours LED
- Illumination Output: 140 lumens
- Run time: 1.5 hours

Black. Limited lifetime warranty. Includes: removable pocket clip, removable wrist lanyard and 2 AA batteries

Description	Item	Length	Weight	Price
Mini-TAC	6R1-FH940	5½"	2.3 oz	\$16.99
Mini-TAC Gooseneck	6R1-FH939	15½"	5.2 oz	\$19.99

AA Batteries **6R1-FH207 \$4.99/2 pk**

VISIT US ONLINE



Shop our full assortment of tactical lights online at:
galls.com/tactical-flashlights

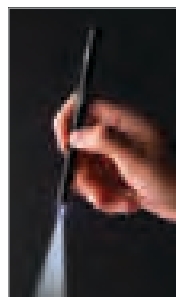

Silver

Black

STREAMLIGHT

Streamlight® Stylus™ LED Penlight

Streamlight® Stylus™ LED Penlight is ideal for use in forensic investigations.

- Tempered aircraft aluminum body; with knurled grip
- Durable polycarbonate lens
- Momentary blink tailcap or twist for constant "on"
- Uses 3 AAAA batteries (included)

Colors: Black, Silver. LED: Blue, Green, Red, White. 6¾"L. 1¼ oz

6R1-FL216 \$14.69

AAA Batteries **6R1-FL510 \$9.99/2 pk**

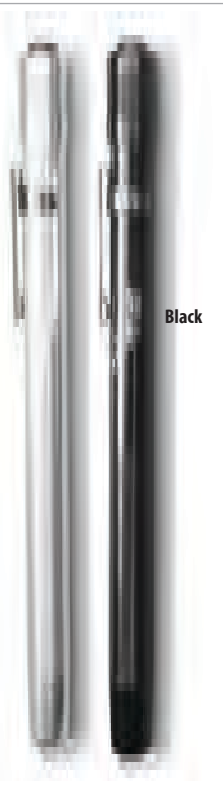

Illumination Tools



COAST® G20 Pen Light

The slim G20 fits perfectly in a pocket, tool bag, purse or briefcase.

- 36 lumens
- 10 hrs run time
- Powered by 2 AAA batteries (included)

5½" L. 2.4 oz

6R1-FH408 \$14.89

COAST® HP2 Pen Light

Features COAST's universal focusing optic system for adjustable flood-to-spot lighting.

- 85 lumens
- 2.75 hrs run time
- Powered by 1 AAA battery (included)

4" L. 1.4 oz

6R1-FH908 \$27.69

COAST® HP3 Pen Light

Adjustable-focus and versatility in a pocket-sized package.

- 105 lumens (high), 5 lumens (low)
- 2.25 hrs run time (high), 3 hrs run time (low)
- Powered by 2 AAA batteries (included)

5¾" L. 2 oz

6R1-FH910 \$33.19

COAST® HP4 High Performance Flashlight

Specifically designed for high lumens in a compact size, excellent for confined spaces.

- 100 lumens
- 3.5 hrs run time
- Powered by 2 AAA batteries (included)

5¾" L. 2.2 oz

6R1-FH906 \$37.39

AAA Batteries **6R1-FH206 \$4.99/2 pk**



No Hassle Guarantee

See p. 98



130 Lumens



130 Lumens

Fenix LD09 Flashlight

This compact, IPx8 waterproof light offers features a Cree XP-E2 LED with digitally regulated output to maintain constant brightness throughout battery life.

- Durable Aircraft grade aluminum
- High: 130 Lumens (1 hour 30 minutes with Ni-MH battery; 56 minutes with Alkaline battery)
- Mid: 55 Lumens (5 hours with Ni-MH battery; 3 hours with Alkaline battery)
- Low: 8 Lumens (40 hours with Ni-MH battery; 50 hours with Alkaline battery)
- SOS Mode: 55 Lumens
- Toughened ultra-clear glass lens with anti-reflective coating
- Multi-function tail switch for momentary-on, constant-on and output selection
- Powered by 1 (Ni-MH, Alkaline) AA battery

Black. 3½". 4 oz

6R1-FL091 \$40.29

AA Batteries **6R1-FH207 \$4.99/2 pk**

Fenix E12 Flashlight

The Fenix E12 uses a single AA battery to produce 130 lumens with up to 22 hours run time.

- Durable Aircraft grade aluminum
- Cree XP-E2 LED
- Digitally-regulated output maintains constant brightness
- Broad beam lens provides a soft, even beam
- 130 lumens (high), 50 lumens (mid), 8 lumens (low)
- 60 minute run time (high), 390 minutes (mid), 22 hrs (low)
- Tail cap switch for on/off and output selection
- IPx8 waterproof
- Powered by 1 AA battery (included)

Black. 6½". 3 oz

6R1-FL100 \$28.89

AA Batteries **6R1-FH207 \$4.99/2 pk**



115 Lumens

Attaches above or below brim on any helmet! Fire, Industrial or Hard Hats!



Streamlight® Vantage Light

Clamp-on 360° rotational C4 LED light is virtually indestructible and has 50,000 hours lifetime!

- ANSI/NEMA FL1-2009 compliant. Now meets NFPA 1971-8.6 (2007) for heat resistance test
- Up to 4500 candela peak beam intensity/115 lumens
- Features ultra-bright blue taillight with a 100,000-hour lifetime
- Body made of anodized aircraft aluminum with unbreakable polycarbonate lens
- Waterproof to 1 meter for 30 minutes

3¼" L. 5 oz. Includes: two CR123 lithium batteries

6R1-FL820 \$105.99

CR123 Batteries **6R1-FH211 \$19.99/6 pk**



Dual Direction On/Off Switch and Blue LED Tail Light

Hands-Free Lighting

Energizer.

Energizer® 3 LED Headlamp

Energizer, a leading name in flashlights and portable lighting, brings you this power-packed headlamp that is as rugged and dependable as it is affordable! Includes 2 versatile lighting modes, and comes pre-loaded with reliable Energizer® batteries.

- 2 bright white Nichia LED's deliver approx. 28 lumens with 50 hour run time
- 1 bright red night vision LED with 150 hour run time
- Pivoting head
- Adjustable elastic headband
- Convenient on/off slide switch

Olive Green housing. Includes: 3 AAA Energizer Max® alkaline batteries

6R1-FH227 \$16.79

AAA Batteries **6R1-FH206 \$4.99/2 pk**



28 Lumens

5.11



5.11 Tactical® SR H2 Headlamp

Small, lightweight, and easy to stow in a pack, the SR H2 Headlamp offers outstanding versatility and easy to use task lighting.

- Red, green and blue mission-specific filters for spot and flood modes
- Spot mode also includes strobe option
- Individual switches for off/high/low on both spot and flood modes
- Mounts to front of shoulder straps on most 5.11 backpacks
- Compatible with MOLLE/web platform

Includes two Duracell® AAA batteries

6R1-FL837 \$39.99

AAA Batteries **6R1-FH206 \$4.99/2 pk**



Nightstick® Helmet-Mounted Dual-Light™ Flashlight

Dual-Light™ technology gives you both a front-facing flashlight and bottom-facing floodlight for considerable scope.

- Meets the requirements for NFPA-1971-8.6 (2013)
- ADC12 aluminum alloy construction
- Impact and chemical resistant
- CREE® LED technology
- Dual button switch

Includes two lithium batteries. 3¼" L. 5 oz

6R1-FL351 \$89.95

CR123 Batteries **6R1-FH211 \$19.99/6 pk**



220 Lumens



Streamlight® Protac HL Headlamp

When you require hands-free performance with intense lighting capability, choose the Streamlight Protac HL Headlamp.

- Meets IPx4 water resistance ratings
- Lumens: 540 lumens (high), 95 (med), 18 (low)
- Run time: 1¼ hours (high), 8 hours (med), 36 hours (low)
- Multi-function, push button switch with TEN-TAP™ programming
- Gasket sealed gas lens

3¾" L. 6.6 oz. Includes two CR123 batteries, elastic headband and rubber headband

6R1-FH724 \$75.59

CR123 Batteries **6R1-FH211 \$19.99/6 pk**



for Any Situation



NEW



Petzl® TACTIKKA Headlamp

This compact, watertight headlamp boasts a number of lighting modes. Simple to operate with a pushbutton switch, even while wearing gloves.

- CE certification
- IPx4 weather resistant
- White lighting modes: ambient 5 lumens; proximity 40 lumens; rapid movement 110 lumens; boost 160 lumens; red light 5 lumens
- Run times: ambient 100 hours; proximity 8 hours; rapid movement 2 hours; boost is a burst of 160 lumens for 10 seconds; red light proximity 100 hours; strobe for 400 hours
- Automatically switches to reserve mode when batteries are running low;
- 3 AAA (included)
- Washable headband

Colors: Black, Desert

6R1-FH868 \$46.19

AAA Batteries **6R1-FH206 \$4.99/2 pk**

TACTIKKA RGB Headlamp: White or red/green/blue lighting maintains night vision and guarantees stealth. Black.

6R1-FH603 \$60.89

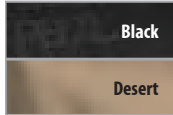

Pelican™ 9440 LED Pop Up Remote Area Lighting System

The function features and coverage you need in a portable area light. Features a heavy-duty deployment lever for speedy mast extension and reaches 7 feet high for optimal coverage. This RALS has a NiMH internal battery providing up to 6 hours of continuous light and features battery status indicator for your convenience. The 2400 lumens light the entire area for safe and swift operation.

- 10 maintenance free LEDs with 50,000 hours of life
- Up to 2400 lumens and 2 brightness settings
- 120 degree beam spread
- Low battery warning
- Unconditional lifetime guarantee
- RoHS Compliant
- Head measurements: 7 $\frac{7}{8}$ " L x 7 $\frac{7}{8}$ " W x 3 $\frac{1}{2}$ " D
- Closed/Portable measurements: 37 $\frac{1}{2}$ " L x 8" W
- Deployed Dimensions: 86 $\frac{1}{4}$ " H

16 lbs. Internal NiMH rechargeable battery and adjustable carrying strap included

6R1-SL099 \$1091.99



Questions?

Our customer service representatives are here to help you Monday-Friday 8:00 a.m. - 9:00 p.m. ET. Call 800.477.7766 today to place an order, ask a question or learn more about our products.



Streamlight® The Siege Lantern

Compact and waterproof, The Siege provides 360° of soft illumination and even floats if dropped in deep water.

- IPX7 waterproof up to 1m submersion
- Ergonomic handle locks into upright or stowed position
- Output (White LED): 340 lumens (high), 175 lumens (medium), 33 lumens (low)
- Runtime (White LED): 30 hours (high), 70 hours (medium), 295 hours (low)
- Output (Red LED): 10 lumens (steady), 10 lumens (flash SOS), 10 lumens (night vision)
- Runtime (Red LED): 235 hours (steady), 430 hours (flash SOS)
- Uses three "D" cell alkaline batteries (sold separately)

Coyote Tan, 7.5"L, 31 oz (with batteries)

6R1-FH688 \$37.49

D-cell Batteries **6R1-FH209 \$23.99/8 pk**



340 Lumens



200 Lumens



NEW



AA Siege Lantern: Just like its big brother, but more compact.

- Output (White LED): 200 lumens (high), 100 lumens (medium), 50 lumens (low)
- Runtime (White LED): 7 hours (high), 15.5 hours (medium), 37 hours (low)
- Output (Red LED): 0.7 lumens (steady), 0.7 lumens (flash SOS)
- Runtime (Red LED): 192 hours (steady), 288 hours (flash SOS)
- Uses three "AA" alkaline batteries (sold separately)

Coyote Tan, 5 $\frac{1}{2}$ " L, 8.8 oz (with batteries)

6R1-FL143 \$31.99

AA Batteries **6R1-FH207 \$4.99/2 pk**

AA Siege Lantern Pink: Streamlight helps light the way to a cure. For every pink Siege AA sold, Streamlight will donate \$2 to the Breast Cancer Research Foundation®. Pink

6R1-FH915 \$33.99

AA Siege Lantern Magnetic Base: This versatile mini scene light features a magnetic base for instant mounting to vehicles and other surfaces. Yellow

6R1-FH916 \$34.99

Streamlight® SURVIVOR C4 LED Flashlights

They're two to three times brighter than previous LEDs, plus provide 50,000 hours of life. Now also have a moonlight mode that switches to a very low setting that lasts for days. Available with steady or fast charger. Uses rechargeable NiCad battery or Alkaline battery pack (both sold separately).

- ANSI/NEMA FL1-2009 compliant. Hazardous approved. Class I, Div. 1 approved
- Tough nylon body; water-resistant O-ring sealed; spring-loaded belt clip
- Deep-dish reflector produces narrow beam, ideal for cutting through smoke; 21,000 candela peak beam intensity, 120 lumens (high); 7,500 candela (low)
- Run time: NiCad, high beam is 3½ hours, low beam 10 hours; alkaline, high beam is 4 hours, low beam 14 hours
- Raised push-button switch

7½"H. 17 oz (NiCad). 13.3 oz (Alkaline)

Description	Item	Price
Alkaline Model	6R1-FL596	\$61.79
NiCad Flashlight Only	6R1-FL597	\$109.19
Steady Charger AC/DC	6R1-FL598	\$123.59
Fast Charger AC or DC	6R1-FL599	\$178.49
Alkaline Battery Pack	6R1-FL600	\$5.39
NiCad Div. 2 Battery Pack	6R1-FL304	\$52.49



Orange
120 Lumens

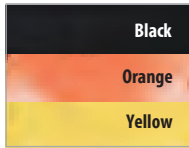

Work Light
Yellow Black
200 Lumens



Spot Fire
Orange
180 Lumens



Streamlight® Knucklehead LED Flashlights

These tough flashlights each feature ultra-bright C4® LED technology and an innovative 360° rotating head for total control of light placement. Can be purchased to use NiCd battery pack or four AA alkaline batteries.

- Two-meter impact tested and IPX4 water-resistance rated
- Nylon polymer body for exceptional durability
- Shockproof dual C4® premium LED technology
- Four modes: high, low, moonlight and flash
- Rubber dome push-button actuator is easy to operate when wearing heavy gloves
- Removable magnet with 135 lb pull strength features a replaceable rubber boot
- Includes alligator clip for attaching to turnout gear

Orange
9½"H. NiCd 23 oz. Alkaline 18.3 oz. Colors: (FH033, FH032) Yellow, Black. (FH194, FH195)

Work Light	6R1-FH033	
With AC or DC Charger		\$168.29
With AD (AC & DC) Charger		\$178.49
Light only	6R1-FH032	\$106.99

Spot Fire/Rescue Light (with AC or DC Charger)	6R1-FH194	\$181.89
Light only	6R1-FH195	\$104.99



Galls® Rechargeable Halogen Spotlight

1,000,000 candlepower Rechargeable Halogen Spotlight is great for roadside emergencies, power failures and much more.

- High power quartz halogen bulb
- LED charge indicator light
- Lockable trigger switch for hands-free use
- Comfort grip with built-in hanging hook and tripod hole
- Includes both car charger (DC) and household (AC) charger

Black. 8¼"H x 5¾"W x 4¾"D. 3.5 lb

6R1-FH011 \$36.99



1,000,000
Candlepower



Streamlight® Waypoint C4 Spot Light

Use batteries or plug to an outlet source.

- High-impact polycarbonate housing
- 115,000 candela peak beam intensity/210 lumens (high) and 10,000 candela peak beam intensity/ 20 lumens (low)
- Deep-dish parabolic reflector produces a long-range targeting beam with optimum peripheral illumination
- Trigger-style switch
- Run time (using alkaline batteries): 8 ½ hours (High) and 120 hours (low or strobe)
- Intensity modes: High, Low or Strobe

7½"H x 6¾"W x 3½"D. 1.8 lb (with batteries). Lanyard and 12V DC power cord included. Colors: Yellow or Black

Description	Item	Price
Alkaline	6R1-FL954	\$66.99
AC/DC Charger	6R1-FH192	\$136.39
Holder	6R1-FH193	\$9.99



Yellow
210 Lumens



Black
Can be used hands-free



Streamlight® Vulcan Series Lights

Vulcan® series include a strong center beam and the ability to recharge in eight hours.

- ANSI/NEMA FL1-2009 compliant; NFPA 1901; FM Class I, II, III, Div. 2
- Unbreakable, polycarbonate lens
- Waterproof
- 80,000 candlepower/150 lumens

7½"H x 5"W x 5¾"D



AC/DC Fire Vulcan
150 Lumens

Fire Vulcan (FL414): Two programmable lighting modes including steady and blinking blue taillight LEDs.

- Three-position toggle switch, quick release strap, high clearance handle
- Run time: 3 hours

Vulcan (SL022)

- Toggle switch and dual filament 8W safety Xenon bulb that delivers an instant backup beam
- Run time: 3½ hours

Fire Vulcan LED (FL819): Deep-dish parabolic reflector produces a tight beam with peripheral illumination and blue LED taillight

- C4 LED lasts 50,000 hours and recharges in 5 hours
- Run time: 3 hours (high), 6 hours (low)

Description	Battery Type	Weight	Color	Item	Price
AC/DC Fire Vulcan	FL526	3.3 lbs	Orange	6R1-FL414	\$135.19
AC/DC Vulcan	FL526	3.3 lbs	Yellow	6R1-SL022	\$145.59
Fire Vulcan® LED	FH137	1.9 lbs	Orange	6R1-FL819	\$199.99



140 Lumens

Streamlight® 3AA ProPolymer Dualie

Circumvent stumbles and falls while simultaneously identifying objects at a distance. Beams intersect for optimum path illumination and no blind spots.

- IPX7 rated; waterproof to 1 meter for 30 minutes; 2m impact resistance tested
- Dual head switches on either side of the body for easy beam selection
- Built-in, snag-free clip
- Operates on three AA alkaline batteries (included)

Colors: Black, Yellow. 7" L. 6.8 oz

6R1-FH891 \$34.99

AA Batteries **6R1-FH207 \$4.99/2 pk**



NEW



150 Lumens

Streamlight® 3AA ProPolymer Dualie Laser

Includes a red laser pointer as well as the same features listed above. LED/Laser combo runs 12 hours.

6R1-FH890 \$44.99



NEW

160 Lumens

EMI Star-Power™ Illuminator

Star-Power™ Illuminator provides light by simply extending the telescoping body to instantly illuminate 10 powerful LEDs.

- Rugged ABS housing
- High-impact-resistant lens
- Shockproof and water resistant
- 160 lumens
- 100,000 hours of life
- Top spotlight only: 8 hrs runtime, main body lights: 6 hrs runtime, both : 4 hrs runtime
- Non-slip rubberized grip
- Magnetic base
- 3 AAA batteries (included)

Colors: Black, Blue, Red. 7½" L x 1¼" W. 5 oz

6R1-FL700 \$17.19

AAA Batteries **6R1-FH206 \$4.99/2 pk**

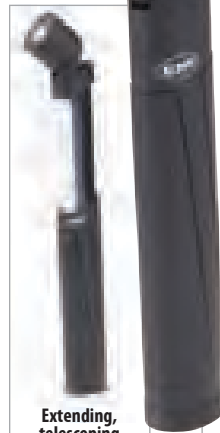

Extending, telescoping body with 10 powerful LEDs



Yellow

C4 LED
130 Lumens

C4 LED HP
150 Lumens

Black

Streamlight® PolyTac C4 LED

Streamlight's virtually indestructible nylon polymer tactical light comes with a super-bright, 50,000-hour C4 LED bulb. It's two to three times brighter than a High-Flux LED.

- ANSI/NEMA FL1-2009 compliant
- Adjustable head for variable spot-to-flood focus with unbreakable polycarbonate lens
- HP model has up to 15,000 candela and 150 lumens system output
- 3-hour run time
- Tail cap button provides momentary or constant on option; rotates for safe position
- Waterproof

FL877: Black or Yellow. 5½" L. 4.1 oz

FL895: Black or Yellow. 5¾" L. 4.4 oz, Includes: 2 CR123 lithium batteries

Description	Item	Price
C4 LED	6R1-FL877	\$41.19
C4 LED HP	6R1-FL895	\$57.79
CR123 Batteries	6R1-FH211	\$19.99/6 pk



45 Lumens

\$14.99



Galls® LED Work Light

Our work light delivers 45 lumens of light wherever. Features a built-in magnetic base for attachment to vehicles or most other metal surfaces.

- Aluminum housing with plastic lens
- 45 lumens, 6 hrs run time
- Magnet built into base of handle for convenient mounting
- Operates on 3 AAA batteries (sold separately)

Gunmetal. 8" L. 8 oz

6R1-FL220 \$14.99

AAA Batteries **6R1-FH206 \$4.99/2 pk**



Streamlight® ProPolymer 4AA Helmet Kit

Includes 4AA propolymer 1W Super High-Flux LED Yellow Flashlight (FL550 - 7" L; 4 AA batteries included), Black Jack Helmet Clamp (FL541), Rubber Helmet Strap (FL542).

6R1-FL868 \$59.99 SAVE OVER 25%
\$81.93.97 if purchased separately

AA Batteries **6R1-FH207 \$4.99/2 pk**

Streamlight Rubber Helmet Band **6R1-FL542 \$3.99**

Helmet Mount for Surefire 6P/Surefire G2 Nitrolon/Pelican M6 Flashlights **6R1-FL879 \$26.95**

Helmet Mount for Pelican Stealth/Streamlight 2-AA Flashlight **6R1-FL870 \$26.95**

Helmet Mount for Streamlight 4-AA Flashlight **6R1-FL541 \$24.99**



100 Lumens

Roadside Visibility for Safe Traffic Direction

150 Lumens



NIGHTSTICK
Life Depends on Light™

Nightstick® Pro 2-in-1 Safety Traffic Light

The Nightstick Pro Safety Light series is by far the safest light to carry when directing traffic or marking a hazardous area. Meets European Community Directives.

- Super bright LEDs produce exceptionally powerful light for its size: 150 lumens CREE® LED; 120 lumens colored LED safety light (60 LEDs); 35,000 hour LED life
- 2-switch: momentary or constant flashlight, and safety light, constant or flashing
- Heavy-duty removable magnetic clip attaches to any steel object for hands-free operation
- Lanyard ring for belt. Oval shape is ergonomically comfortable. Rugged polymer housing. Impact and moisture resistant. Non-slip textured body and soft-touch finish
- Powered by 4 premium AA alkaline batteries (included)

Colors: Constant flashing, Red, Blue, White; Alternate Flashing, Blue/Red, White/Red; Constant White/flashing Amber. LED Colors:  10%*L

6R1-HS384 \$34.95

AA Batteries	6R1-FH207 \$4.99/2 pk
Safety Traffic Light Cones	6R1-HS385 \$4.99
Magnetic Stand	6R1-HS386 \$5.99
Heavy-Duty Magnetic Base	6R1-HS387 \$7.99

Cones



Magnetic Stand



Heavy-Duty Magnetic Base

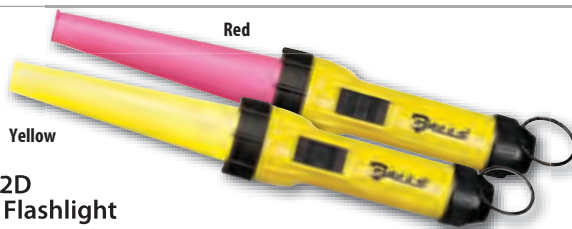

Galls® 2D Traffic Flashlight

Galls Traffic Flashlights feature durable ABS plastic with snap on/off wand. 7,000 candle power. Spare bulb included.

Colors: Red or Yellow wand. 14½"L. 4.5 oz

6R1-FL338 \$12.79

D-cell Batteries **6R1-FH209 \$7.99/2 pk**

GALLS®

Galls® LED Traffic Baton

Features three white LEDs inside the end cap, three red LEDs and red reflector.

- Equipped with both a Red LED flash setting, Red LED steady on and White glowing flashlight on the end
- Strong magnet on bottom to attract to metal
- Uses 3 AAA batteries (included)

12½"L. 4.4 oz

6R1-HS341 \$18.19

AAA Batteries **6R1-FH206 \$4.99/2 pk**



LED flashlight on the end

GALLS®

Galls® 2-Cell LED Traffic Baton

Baton is very light and uses long-lasting LEDs.

- Features 6 red LED lights and a red reflector for maximum visibility
- Equipped with 2 flash patterns and a steady burn option
- Uses 2 C batteries (sold separately)

21"L. 5 oz

6R1-HS266 \$22.99

C Batteries **6R1-FH208 \$6.99/2 pk**



Flare Alert Small LED Beacon Flare Kit

No more risks of incendiary/strike flares or the hassle and expense of disposable flares.

- Includes 3 LED beacons in a small storage bag; each beacon contains 1 LED (.5 watt) and a magnetic base
- Dual lighting options - steady or flashing; run-time: steady mode 20+ hours; flash mode 70+ hours
- Works in all weather conditions and never expires
- Crush resistance: 20,000 lbs vehicle
- Requires 4 AA alkaline batteries in each beacon (sold separately)

Storage bag: 6"H x 9"W x 4"D. Beacons: 3¾"H x 1¾"D. 7 oz (with batteries)

6R1-HS405 \$45.99

AA Batteries **6R1-FH207 \$19.99/16 pk**



Orion® Road Flares (Case of 36)

Rugged flares burn in driving rain, hail, sleet or snow. Radiates a burning red color with minimum splatter.

- Flares meet ICC specs
- Specified and approved by the Bureau of Explosives and by Underwriters Laboratories
- Case of 36

Shipped ground service only. Add an additional \$15.00/box for required hazardous material handling charges. Shipped within the continental U.S. only. Quantity pricing available, call for details.

Description	Burn Time	Item	Price
No Stand	30-min	6R1-HS392	\$99.99
Wire Stand	20-min	6R1-HS393	\$84.99
Wire Stand	30-min	6R1-HS394	\$114.99



Galls® Flare Containers

Water-resistant flare containers come in sizes to fit either 20 or 30 minute flares.

- Durable plastic container has a carrying handle and a can't-lose flip-top lid
- Small: 20-min flares; Large: 30-min flares

Red. Small: 14½"L. Large: 17¾"L. Both: 5" Dia

6R1-HS208 \$16.89+



Visit us online for pricing on additional options.

Kit comes complete with everything you see here

B Beacon Kit



Red

A



Beacon

Weighted bases and cone adapters combine to give the beacon height

NEW

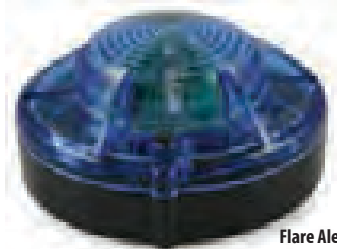

C

Flare Alert Beacon Pro

Flare Alert Beacons

Unlike incendiary/strike flares, Flare Alert LED beacons are completely safe. No more risk of inhaling toxic fumes, starting brush fires, igniting spilled fuel/oil, burning equipment or yourself. An environmentally responsible option compared to flares that are considered hazardous waste.

- Beacons can withstand a 20,000-lb vehicle
- Weighted bases are heavy enough to keep the beacon stationary when landing helicopters
- Cone adapters can be placed in the top of cone openings to raise light visibility off the ground
- Replacement beacons, weighted bases and cone adapters available below
- Requires four AA alkaline batteries (sold separately)

Beacon Colors: ■ Red ■ Amber. Beacon measures 3¾"H x 3¾"W x 1¾"D.

A) 6R1-HS280 \$16.99

Universal Weighted Base **6R1-HS283 \$10.99**

Universal Cone Adapter **6R1-HS282 \$10.99**

AA Batteries **6R1-FH207 \$19.99/16 pk**

Flare Alert Beacon Kit: Includes (8) FlareAlert Beacons, (8) universal cone adapters, (8) universal weighted bases and a durable polyester bag.

Bag measures 10½"H x 12¾"W x 2¾"D

B) 6R1-HS348 \$259.99

Flare Alert Beacon Pro

Same size, twice as bright, the Beacon Pro is safe for anyone to use.

- 1W LED and a magnetic base with rubber feet
- Dual lighting options: steady or flashing
- Run time: steady mode 20+ hours; flash mode 60+ hours

C) 6R1-HS402 \$20.29

AA Batteries **6R1-FH207 \$19.99/16 pk**



Cortina Heavy-Duty Traffic Cones

All meet MUTCD requirements for design; only orange cones meet MUTCD for federal and state highways. These heavy-duty PVC cones come plain (non-reflective) or with reflective collars for added visibility.

- Weighted bottoms
- Choose from three heights
- Purchase single cones, or **SAVE** by buying in boxes of 5, 8, or 10 cones

Orange (Non-Reflective). Orange

Non-Reflective

Size	Qty	Item	Price
18"	10	6R1-HS059	\$124.89
28"	5	6R1-HS060	\$105.19
36"	8	6R1-HS118	\$217.19

Reflective

Size	Qty	Item	Price
18"	10	6R1-HS117	\$188.99
28"	5	6R1-HS021	\$161.59
36"	8	6R1-HS119	\$334.79



Shipping Instructions for Cones

If buying boxes of 18" or 28" cones: Add \$12.00 per box for shipping.

If buying boxes of 36" cones: Add \$20 per box for shipping.

All cones are shipped via ground service, unless otherwise specified. Alternative shipping methods require an additional shipping charge.

Please call for details.



Cortina Pack and Pop Cones

Ideal for vehicle storage. The cones collapse and fit in a compact, carrying bag.

- Meets MUTCD requirements
- Waterproof, orange nylon construction
- 4"H reflective stripe near top; 2 reflective stripes
- Internal LED for even more visibility; 2 settings, steady and flashing. Uses 2 AAA batteries (included)

30"H x 13"W x 13"D. Includes: feet for additional stability

6R1-HS339 \$217.49/5 pk

AAA Battery 6R1-FH206 \$4.99/2 pk



Includes FREE Carrying Case

Titles

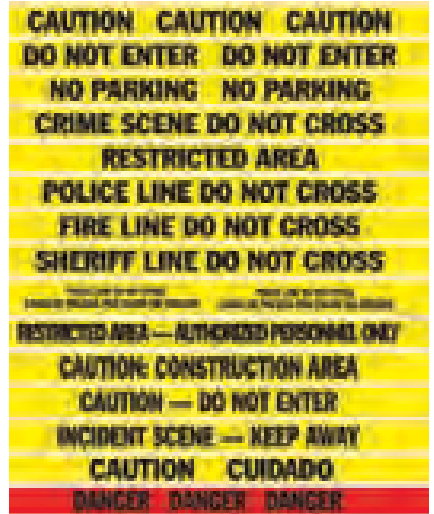

Buy in Bulk and **SAVE!**

Galls® Barrier Tape

Made of 3"W, 3 mil thick vinyl with easy-to-read black block letters. 1000' roll. Corrugated dispenser case.

Description	Item	Price	SAVE
Single Pack	6R1-HS098	\$14.29	—
5-Pack	6R1-HS286	\$63.19	\$8.26
10-Pack	6R1-HS287	\$111.19	\$31.71

Note: All bulk pack purchases must be for the same title.

Accurate Measuring Tools

A) Keson® Metal Wheel

Compact fold-down design easily reduces to half its size for storage and portability.

- Rugged ¾" steel tubing – strongest frame in the field
- Innovative, simple centerline design, great balance
- Superior counter protection and placement up to 99,999 ft

Dimensions: Circumference 4'. Wheel height 15½". Length: 24" collapsed, 48" extended

6R1-HS344 \$206.99

B) Keson® Kickstand Measuring Wheels

Telescoping handle and kickstand means no more bending over, putting strain on your back.

- Pistol grip for easy guiding
- Five-digit push button counter records up to 10,000 ft without resetting
- Telescoping handle adjusts to a comfortable height and makes for compact storage
- Wide rubber wheel

Dimensions: Circumference 3'. Wheel height 12½". Length 30" collapsed, 41" extended

6R1-HS112 \$86.69

C) Keson® Executive Dual Wheel

Dual rubber wheels make it easier to measure on slick or rough surfaces.

- Five-digit push button counter measures up to 10,000 ft without resetting
- Counts rolling forward; subtracts when rolled backward
- Curved, telescoping handle

Dimensions: Circumference 1'. Wheel height 4". Length: 17" collapsed, 38" extended

6R1-HS254 \$60.19

D) Keson® Compact Executive Measuring Wheel

Can fit inside a toolbox or even a briefcase. Ideal for quick estimating jobs.

- Four-digit counter measures up to 10,000 ft without resetting
- Accurately measures curved, vertical or horizontal surfaces

Circumference 1'. Wheel height 4". Length: 17" collapsed, 38" extended. 1.2 lbs

6R1-HS253 \$43.99

E) Keson® 100' Fiberglass Measuring Tape

Resists breakage and damage under the toughest field conditions.

- Fiberglass tape with two coats of PVC to prevent breaking
- Tough, molded handle with metal-reinforced crank handle
- Double-throat rollers guide the blade to prevent twisting

12"H x 8"W x 1½"D x 3¼"L; weighs 1.5 lbs.

6R1-HS314 \$29.39

F) Keson® 25' Pocket Measuring Tape

Rubber grip prevents slips and protects the tape if it does happen to fall.

- Positive lock and reverse with impact-cushioning "bumper" blade return
- 1" wide, nylon-coated, no-glare, Insty-Read™ blade
- Belt clip

3"H x 1"W x 1½"D x 3¼"L; weighs 12 oz.

6R1-HS345 \$11.79



Cortina Hand-Held Stop/Slow Traffic Sign

Durable, weatherproof sign is effective in potentially dangerous traffic situations. Features "STOP" and "SLOW"

6R1-HS269 \$37.99



Hero's Pride Traditional Whistle Value Pack

Quality, high pitch whistles come three per pack. Available in gold-tone or silver-tone.

6R1-UA001 \$14.19/3 pk



Fox40® Micro Whistle with Breakaway Lanyard

Pealess safety whistle is compact and comes with breakaway lanyard.

6R1-UA680 \$12.79



\$4.99

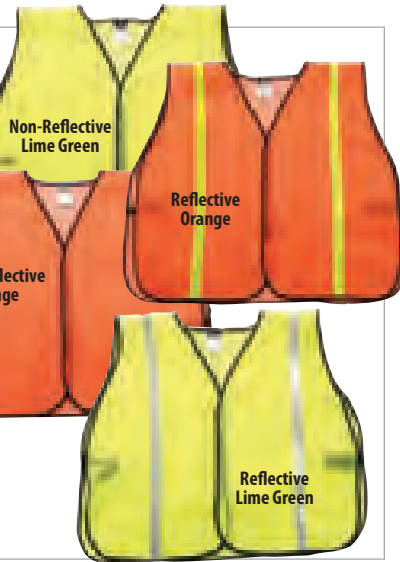

Radians® Mesh Traffic Vests

Remain visible with a non-rated safety vest from Radians.

- 100% polyester mesh is lightweight and highly visible
- Durable elastic side straps
- Front hook-and-loop closure
- Maintains brightness up to 25 washings

Colors: Lime Green, Orange. Universal Sizing

Non-Reflective: 6R1-HS550 \$4.99

Reflective: 1" reflective green or silver stripes on front and back for increased visibility.

6R1-HS551 \$6.99



Galls® Reflective Traffic Vests

Loaded with features to keep you safe and comfortable while doing your job.

- Hook-and-loop side straps for a better fit
- 2 front vertical stripes on the front
- 1 horizontal stripe on the back

Colors: Blue, Lime Green, Orange. Titles: Plain, Crossing Guard, Emergency Services, Fire (x), Police (x), Sheriff(x), Security

Description	Item	Starting at
Nylon Vest	6R1-HS234	\$23.39+
Mesh Vest	6R1-HS235	\$24.59+



Galls® Scotchlite Reflective Mesh Traffic Vest

These vests help keep you visible as well as cool and comfortable.

- Easy-to-clean vinyl coated mesh fabric
- VELCRO® brand adjustable side straps and closure
- 3M™ Scotchlite reflective material

Colors: Blue, Lime Green, Orange. Titles: Plain, Crossing Guard, Emergency Services, Fire (x), Police (x), Sheriff(x), Security

6R1-HS190 starting at \$37.39+

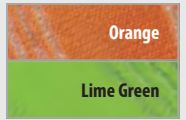

Galls® Reflective Safety Gloves

Polyester reflective safety gloves feature brilliant 3M™ Scotchlite™ reflective material, so they're an affordable, simple way to add visibility to your ensemble.

One size fits all

6R1-GL249 \$13.19

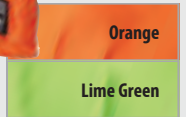

Ringers® Hi-Vis Traffic Gloves

More visible than standard gloves, these traffic gloves are made of light reflective fabric. Reflective stripes on the palm provide added visibility. Quick pull-on design for easy on/off.

Sizes: S-2X, see size chart O on p. 145

6R1-GL412 \$15.29

+ Visit us online for pricing on additional options.

Shop for more reflective ANSI & Safety apparel and accessories starting on p. 126

Stay Visible, Stay Safe



3M
Custom
Title

Standard
Titles



Galls® ANSI Breakaway Zip-n-Rip™ Vest

This ANSI/ISEA 207-2006 compliant vest features a five-point breakaway design that allows you to avoid an untimely snag from a moving vehicle or a criminal takedown.

- Polyester micro-mesh fabric
- Zipper front rips away for quick on/off
- Side access cutouts for easy access to belt
- Attached mic and pen holder on both shoulders
- 3M™ Scotchlite™ reflective trim
- Made in the USA

Yellow. Titles: Standard — POLICE^(X), FIRE^(X), EMS, SHERIFF^(X), Plain. Choose Blue, Green, Red or Black trim to go with custom titles. Sizes: M-4X, see size chart A on p. 98

Description	Item	Starting at
Standard	6R1-HS337	\$29.39
Custom Title	6R1-HS338	\$36.59+



Galls® ANSI Original Breakaway Zip-n-Rip™ Vest

Designed specifically to meet the safety requirements of law enforcement professionals during roadside emergencies. In addition to the common features listed at left, the Galls® Original Vest features:

- ANSI/ISEA 207-2006 for Public Safety Vests; ANSI/ISEA 107-2004 Class II
- Reflective back for increased visibility
- Longer style without encumbering access to belt and weapon



Lime Green

Orange

Titles: Standard, POLICE^(X), FIRE^(X), EMS, SHERIFF^(X), SECURITY, Plain. Sizes: M-4X, see size chart A on p. 98

6R1-HS334 \$46.89



3M

Galls® ANSI Breakaway Vest

Stay safe with a five-point breakaway vest.

- Meets ANSI 207-2006 safety requirements
- Hi-visibility cool micro mesh background fabric
- 2" 3M™ Reflective and black contrast trim
- Patented Zip-n-Rip™ front closure
- Front left side reflective pocket, front right side printed flap pocket
- 2 mic tabs



Lime Green

Orange

Titles: Standard, POLICE^(X), FIRE^(X), EMS, SHERIFF^(X), SECURITY, CROSSING GUARD, Plain. Sizes: M-4X, see size chart A on p. 98

6R1-HS371 starting at \$53.29+



Galls® ANSI Hi-Vis Traffic Vest

Five-point breakaway vest offers hi-visibility and many safety features.

- Meets ANSI 107-2010 Class II
- 2" 3M™ reflective and black contrast trim
- Drop Shoulder Design for comfort
- Patented Zip-n-Rip™ front closure
- Adjustable sides
- Dual front print/back print
- 2 mic tabs

Lime green. Titles: Standard — POLICE^(X), FIRE^(X), EMS, SHERIFF^(X), SECURITY, Plain. Sizes: M-4X, see size chart A on p. 98

Description	Item	Starting at
Standard	6R1-HS370	\$25.19+
Custom Title	6R1-HS379	\$30.99+

Breakaway
Shoulders



Breakaway
Side

3M



3M

Galls® ANSI Breakaway Public Safety Vest

Take charge with a five-point breakaway vest.

- Meets ANSI 207-2006 safety requirements
- Hi-visibility Cool Micro Mesh Background fabric
- 2" 3M™ Reflective and black contrast trim
- Patented Zip-n-Rip™ front closure; 2 mic tabs

Lime green. Titles: Standard, POLICE^(X), FIRE^(X), EMS, SHERIFF^(X), SECURITY, Plain. Sizes: M-4X, see size chart A on p. 98

6R1-HS369 starting at \$53.29+

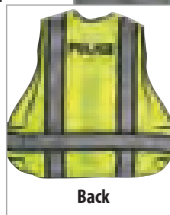

(X) Visit us online for restricted item info.

Ordering online? Use your PROMOTIONAL CODE from the back cover

800.477.7766 • galls.com

213

Everyday Carry (EDC) Knives and Tools

COAST
SMITH & WESSON®



COAST® Spec Ops Collection Folding Knives

Made for real world challenges and built with Coast's patented Double Lock technology. Liner lock automatically engages and locks the blade open. Activate the Double Lock switch to prevent the knife from accidentally closing. Backed by Coast's lifetime warranty.

- 9CR18MOV stainless steel blade with black finish
- Stainless steel frame and lightweight nylon handle in subdued gray
- Patented Double Lock safety switch mechanism works in conjunction with the liner-lock to prevent disengagement

TX395: Strong enough to pry open an ammo box or break a window with the integrated glass breaker. 9" L open. 4" blade. 7.7 oz

6R1-KN892 \$55.89

TX399: Reversible thumb stud for easy one-handed opening. Two-position pocket clip for versatile carry options. 9" L open. 4" blade. 3.7 oz

6R1-KN891 \$48.79

TX360: Reversible thumb stud for easy one-handed opening. Two-position pocket clip for versatile carry options. 8" L open. 3 1/4" blade. 3.4 oz

6R1-KN893 \$43.69



Smith & Wesson®

Smith & Wesson M.A.G.I.C. Knives

Multipurpose Assisted Generational Innovative Cutlery is the dual-patented assisted opening mechanism from S&W that is as powerful as it is easy-to-use.

- Ergonomically designed for firm, natural grip
- Perfectly placed finger launcher and thumb stud provide two convenient methods for instant blade access
- Liner and safety locks secure blade when open or closed
- Pocket clip and lanyard hole for convenient carry options

Black Ops Knife with Drop-Point:

- Black 4034 steel blade with combo edge, drop point
- Aluminum handle with textured finger grooves for reduced weight and a secure grip

7 3/4" L open. 4 1/2" L closed. 3 3/8" L blade. 4.2 oz

6R1-KN592 \$40.99

Smith & Wesson®

Smith & Wesson® M.A.G.I.C. Black Ops Knife with Tanto Point

Multipurpose Assisted Generational Innovative Cutlery is the dual-patented assisted opening mechanism from S&W that is as powerful as it is easy-to-use.

- Ergonomically designed for firm, natural grip
- Finger launcher and thumb stud provide two methods for instant blade access
- Liner and safety locks secure blade when open or closed
- Pocket clip and lanyard hole for convenient carry options
- Aluminum handle with specially designed ridges for grip

Handle Color: Black. 7 3/4" L open. 4 3/8" L blade. 4.8 oz

6R1-KN505 \$48.99



5.11

5.11 Tactical® Game Stalker Sheath Knife

Built to survive your world, this fixed blade knife offers remarkable versatility and cutting power. The handle features an ergonomic hourglass shape with contoured texturing for improved grip. Aggressive jimping on the back of the black allows precise control. The rugged full-tang design is complemented by a MOLLE- and belt-compatible ambidextrous FRN sheath.

- Plain edge, AUS8 stainless steel, drop point blade
- Large thumb platform and aggressive jimping
- Textured FRN handle
- MOLLE- and belt-compatible ambidextrous FRN sheath

3 3/4" L blade.

6R1-KN865 \$119.99

Smith & Wesson®

Smith & Wesson® HRT Boot Knife

Built for easy carry and concealed, the HRT Boot Knife is the perfect backup knife.

- 7Cr17 High carbon stainless steel
- TPE Rubber Wrapped Handle with Lanyard Hole
- Black leather belt/boot Sheath

7 1/2" L. 4.6 oz.

6R1-KN076 \$17.49

GALLS®



Galls® Fold-Out Seatbelt Cutter

Blade folds and locks in place for safe use. Black rubber handle. Includes nylon pouch.

6 1/2" L open. 4 1/2" L closed.

6R1-KN211 \$24.59

Shop our selection of fire rescue tools on p. 254

From the Brands You Trust

Smith & Wesson® Extreme OPS Rescue Knife

Tanto blade, seatbelt cutter and a glass breaker in one tool with a rubber-coated handle. 8" L open. 3½" L blade. 5 oz

6R1-KN452 \$22.49



Smith & Wesson® First Response Rescue Knife

Features a half-serrated blade, seatbelt cutter and glass breaker all in one. 8" L open. 3¾" L blade. 4.8 oz

6R1-KN348 \$24.99



Stat Gear™ EMS Tek Tool

The EMS Tek Tool packs four vital tools into a compact unit that fits in your shirt or pants pocket.

- Anodized aluminum construction
- 440c stainless steel seatbelt cutter folds and deploys with the slide of a button
- Includes: stainless steel window punch tip, oxygen wrench, smartphone/tablet stylus tip and pocket clip

Black. 5" L x 1½" W. 2 oz

6R1-KN585 \$24.99



Seatbelt cutter deploys at the touch of a button

Stat Gear™ T3 Tactical Auto Rescue Tool

The T3 Tactical Auto Rescue Tool incorporates critical first responder tools into a compact package.

- 440c stainless steel, seatbelt cutter and half-serrated knife blade
- LED 5 lumen light, uses 2 CR1220 batteries (included)
- Includes: Spring-loaded window punch, nylon belt sheath and stainless steel belt clip

Black. 5" L open. 3¼" L blade. 6.4 oz

6R1-KN586 \$39.99



Seatbelt Cutter

Window Punch

Smith & Wesson® Border Guard Tanto Blade Rescue Knife and Tool

Three essential tools in one convenient package.

- Textured G-10 scales for secure grip
- Steel liners and lock tab keep the blade securely open, yet simple to release and close
- Tip-up carry pocket clip
- Blade thickness: ⅛"
- Handle thickness: ½"
- Includes lanyard hole, built-in seat belt cutter and glass breaker pommel

10¼" L open. 4½" L blade. 9.3 oz

6R1-KN096 \$36.79



Ideal for tactical situations



SOG® Escape Rescue Knife

Perfect size for everyday carry. Includes a 3¾" L blade, line cutter, glass breaker and wire stripper. Black or Silver blade finish. 8" L open. 3¾" L blade. 4.8 oz

6R1-KN556 \$45.69

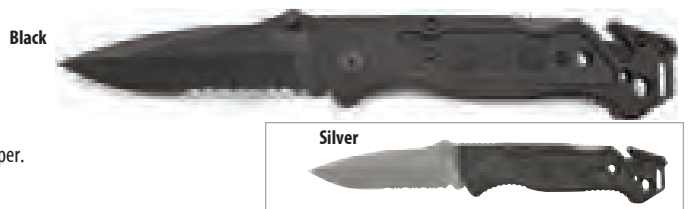

Silver

Smith & Wesson® First Responder Assisted-Opening Knife with Subdued Black Blade

M.A.G.I.C. (Multipurpose Assisted Generational Innovative Cutlery) assisted-opening system.

- Stainless 4034 steel serrated blade
- Liner lock and nylon fiber handle
- Concealed spring-loaded window punch
- Includes external safety lock and pocket clip

8" L open. 3½" L blade. 5 oz

6R1-KN455 \$78.09



Multi-Task Easily With Multi-Tools



Smith & Wesson® SWMT2CP Multi-Tool

Provides you with immediate accessibility to 15 tools. A plethora of features is neatly concealed in this highly functional tool, such as the saw and files.

- 2Cr13 stainless steel tools
- Synthetic handle
- Spring-loaded design makes this versatile tool easy to use in any situation
- Includes: spring loaded needle nose pliers and regular pliers, wire cutter and wire stripper, fine edge blade, large, medium and small flathead screwdrivers, saw, scissors, medium and small phillips head, carabiner clip

Handle measures 4¾" L, 6" overall. 8 oz

6R1-KN848 \$32.99



COAST® LED155 Pro Pocket Pliers

Essential, every-day tools in one compact package.

- 3CR13 steel construction
- 3" L stainless steel knife blade with liner lock
- 2 built-in LED lights (one at each end)
- Includes: scissors, phillips (1) and flathead (3) screwdrivers, cap lifter and can opener, wire stripper

4" L closed, 6" L open. 9.8 oz.

Includes: (2) CR1616 batteries

6R1-KN539 \$49.79

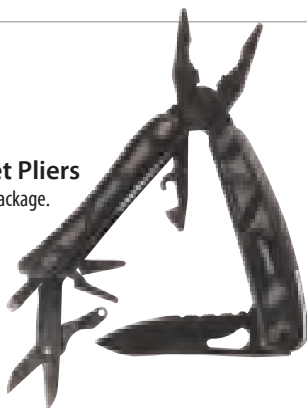

Leatherman® Wave Multi-Tool

Outside-accessible blades can be deployed with just one hand.

- 420 stainless steel construction
- Includes: needlenose and regular pliers, 2 wire cutters, clip point and serrated knife, saw and scissors, 2 files, bit drivers and bits, three screwdrivers, bottle opener, wire stripper, leather sheath

6" L. 8.2 oz

6R1-KN256 \$89.85

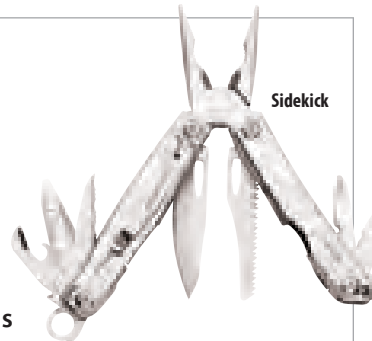

Sidekick

Leatherman® Multi-Tools

Featuring body and blades made of a lightweight 420HC stainless steel and can easily be carried in the pocket or on the tool belt:

- Includes: spring action pliers, wire cutters, 420HC combo knife, carabiner bottle opener accessory, 420 HC serrated knife with 2¾" blade, wood/metal file, bottle opener, can opener, wire stripper, removable pocket clip, small screwdriver, medium screwdriver, phillips screwdriver, ruler

Closed: 3¾" L. 7 oz.

Wingman includes carabiner bottle opener accessory

Description	Item	Item
Sidekick	6R1-KN526	\$38.99
Wingman	6R1-KN527	\$29.99

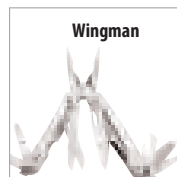

Wingman



Gerber® Diesel Multi-Plier

Easily deploy the needlenose pliers with one hand.

- Stainless steel construction
- One hand deployment of pliers
- Includes: needlenose pliers, wire cutter, wire crimper, partially serrated knife, cross screwdriver, three flat blade screwdrivers, opener, bottle opener, scissors, saw

5¾" L. 9.7 oz

6R1-KN363 \$76.99

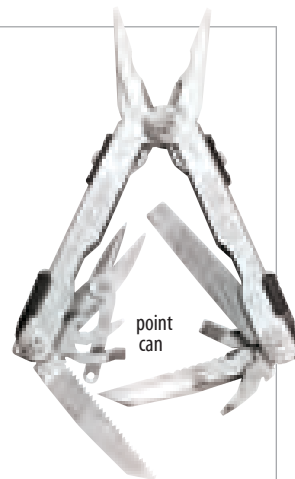

point
can



Leatherman® OHT One Hand Multi-Tool

This industry-first tool features spring-loaded pliers and wire cutters so you don't tire your hand adjusting and readjusting your grip.

- 100% one-hand-operable multi-tool
- Stainless steel body
- All-locking blades and tools
- Includes: 420HC serrated knife, multiple screwdrivers, saw, strap cutter, can opener and bottle opener, oxygen tank wrench, integrated lanyard attachments, #8-32 cleaning rod attachment

Black. Closed: 4½" L. Blade: 2¾" L. 10 oz

6R1-KN615 \$99.85

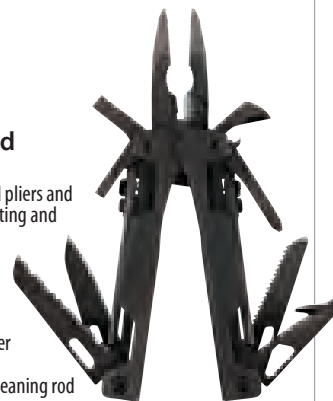

Quickly Access Locked Vehicles

Long Arm
58"L

**EXCLUSIVE
ITEM**

PRO-LOK

PRO-LOK® Rigid Long Arm Tool Kit

Smaller diameter than other models.

- Entry made through door from outside vehicle
- Powder-coated tool with soft vinyl tip
- Soft-coated handle permits easy navigation of tool through door compartment
- Includes: Long Arm tool, inflatable pump wedge, mini rubber wedge and plastic protection sleeve, lock picks

6R1-LT004 \$70.99



Includes lock
pick kit
and instruction
manual



BigEasy™ GLO

Lock Knob Lifter

Paint
Protector

Non-Marring
Wedge

Inflatable
Pump Wedge



Steck BigEasy™ Glo Kit

Glow-in-the-dark BigEasy™ GLO tool makes it even easier to see at night.

- Actuates lock button, door handle or electric locks on most cars and trucks
- Done from outside vehicle in less than 1 minute
- Includes: Glow-in-the-dark BigEasy™ GLO tool, lock knob lifter, paint protector, and plastic non-marring wedge

6R1-LT057 \$45.69

BigEasy™ GLO Lockout Tool Kit: Includes the same tools as above, as well as the inflatable pump wedge for precise control.

6R1-KN202 \$69.99

Little Easy™ **6R1-LT052 \$21.99**

Replacement Non-Marring Wedge **6R1-KN304 \$12.79**

Optional BigEasy™ Carrying Case **6R1-KN305 \$33.79**

Replacement Inflatable Wedge **6R1-KN303 \$32.49**



Optional
BigEasy™
Case



Little Easy™
29" L

PRO-LOK

PRO-LOK® Advanced Lockout Set

Vehicle entry kit in a mini car-opening booklet. Set includes:

- 4 under-the-window tools (handle pull, button lifter, separator and long tool)
- Honda tool, double slide tool, long reach accessory tool and inflatable pump wedge
- Heavy-duty deluxe cloth zippered case

6R1-LT001 \$161.59



Efficient Tools and Accessories



Standard



Galls® StreetThunder™ Megaphones

Our bestselling hand-held, multi-tone sound standard StreetThunder™ megaphone combines 25W power with a 115 decibel siren to provide you with one of the best tools in crowd control.

- Whistle and 4 siren sounds (StreetThunder™, Yelp, Wail and Hi-Lo)
- Handy press-to-talk switches and a revolver switch for selecting sounds
- Feedback suppressing circuitry
- Standard comes with a comfortable pistol grip
- Both come with a shoulder strap for easy carrying
- Uses 8 C-cell batteries

Standard: Simply press the trigger and speak to get more than 900 feet of clear, crisp voice projection.

6R1-AP101 \$89.29

Replacement Rear Cover **6R1-AP551 \$24.39**

Deluxe: Comes with a lightweight mic to hold in your hand and has a 25' long cord.

6R1-AP193 \$101.29

Replacement Rear Cover **6R1-AP552 \$23.99**

Switch Knob **6R1-AP553 \$6.39**

C-Cell Batteries **6R1-FH208 \$6.99/2 pk**



Deluxe

uniden®



Uniden® Bearcat 355C Scanner with TurboSearch

Great for the home, office or vehicle.

- TurboScan™ scans up to 100 channels per second
- Close Call™ RF Capture technology instantly tunes to signals from nearby transmitters
- Receives frequencies 29-54 MHz, 108-174 MHz and 406-512 MHz and 806-956 MHz
- Selective search has 2,193 pre-programmed channels in 6 service banks plus 1 standard, programmable private bank; 50 programmable channels
- Cellular frequencies blocked
- Nine-digit backlit LCD display indicates frequency monitored
- Includes: scanner, bracket, AC adapter, direct wire and telescoping antenna

1½"H x 5½"W x 6⅞"D

6R1-AP044 \$99.99

GARMIN™



Garmin® nuvi 50LM GPS

Reliable, spoken turn-by-turn directions, now on a device with a large 5" touchscreen. Plus, FREE lifetime map updates continue to provide your device with current maps and navigation information.

- Preloaded maps for functionality right out of the box
- Over 5 million searchable points of interest
- Spoken directions also include street names
- Lane assist with junction view to clearly guide you to the correct lane for a turn or exit
- "Where am I?" locator feature for emergencies
- Rechargeable lithium-ion battery with 2-hour run-time
- Includes vehicle suction cup mount and power cable

5½"W x 3⅜"H x ⅜"D. 6.3 oz

6R1-AP740 \$129.99

uniden®

Uniden® 2-Way Radios

Palm-sized, state-of-the-art devices with a rugged design and wide range. Up to 16-mile range, depending on environmental and topographical conditions.

- 22 channels: 15 GMRS, 7 FRS
- Channel scan/monitor
- Backlit display, battery strength meter
- Call button, "Roger" beep, keypad lock, keytone on/off
- Headset compatible

Black. 16 oz. Includes 6 AAA rechargeable NiMH batteries and AC adapter

6R1-AP747 \$29.99

AAA Batteries **6R1-FH206 \$4.99/2 pk**



to Navigate and Communicate



Tactical Ear Gadgets Ghost Ear Mold

Allows the user to hear ambient sounds as well as the radio transmission. The soft rubber is extremely comfortable for long periods of use.

- Soft rubber ear mold for use with all acoustic tube products
- Fitted to either the left ear or right

6R1-AP943 \$6.99

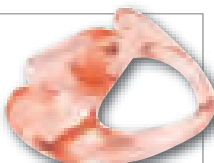

Tactical Ear Gadgets Acoustic Tube Kit

Replacement acoustic audio tubes keep your communications clear.

6R1-AP942 \$8.49



RocketScience® Scorpion Listen-Only 3.5 mm Threaded for Speaker Mic/Adapter

Ideal for when you need to hear without anyone else overhearing. For use with flare, radios, speaker mics and Motorola speaker mic/adapter.

- Eliminates ambient noises
- Very comfortable, adjustable rubber ear loop
- Earpiece cable includes coil cord
- Swivel for either ear

6R1-AP621 \$20.99

3.5mm Non-Threaded **6R1-AP620 \$20.99**



EarHugger®

EarHugger® T-Series Acoustic Tube Headphones

Lightweight and flexible, T-series headphones features clear acoustic tubing that fits comfortable over your ear.

- Perfect for discrete listening
- Soft plastic frame holds lightweight mushroom earbud for added comfort
- Includes left and right open acoustic tube piece and clear and black patented ear frames

\$29.99

Fit
3.5mm Jack
3.5mm Threaded Jack
2.5mm Jack

Item
6R1-AP415
6R1-AP459
6R1-AP477



RocketScience® Star Single Wire Surveillance Earpiece

Easy-to-use, in-line, push-to-talk button with built-in microphone. Great audio quality.

Description

M1-Motorola 2 Pin
Listen Only – Acoustic tube (40" cord, 3.5 mm plug)
Listen Only – Acoustic tube (14" cord, 2.5 mm plug)



Item	Price
6R1-AP586	\$38.39
6R1-AP778	\$46.79
6R1-AP779	\$48.19



Ear Phone Connection Hawk Lapel Mic for Motorola Radios

The Hawk is concealable, lightweight and comes complete with left and right fitted rubber earmolds and Torpedo earbuds.

- Concealable and lightweight
- Excellent audio quality
- Polyurethane-jacketed DuPont™ KEVLAR® cables
- Includes left and right fitted rubber earmolds and Torpedo earbuds
- Quick-release (ZA2869, AP974)

Radio Fits: (ZA2869) Motorola XTS 1500, XTS 2500, XTS 3000, XTS 5000. (AP974) Motorola XPR6300, XPR6350, XPR6500, XPR6550, APX 4000, APX6000, APX7000, APX7500. (AP016) Motorola HT750, HT1250, HT1250LS, HT1550, HT1550XLS; MTX850, MTX850LS, MTX8250, MTX8250LS, MTX950, MTX960, MTX9250, MTP700 Ex, MTP810 Ex, MTP850 Ex, PTX780

Fit	Item	Price
HT, MTX, MTP, PTX	6R1-AP016	\$89.99
XTS	6R1-ZA2869	\$89.99
XPR, APX	6R1-AP974	\$89.99



EarHugger®

EarHugger® Remote Speaker Microphones

This tried and true product is a sturdy, reliable communications device.

- Durable remote speaker mic for hands-free communication
- Transmit and receive capability
- Comes with coil cord and clip back

24" L x 2 1/4" W x 1 1/2" D. 5.3 oz

\$39.99

Fit
Motorola Radios (HT1000, XTS3000, STS5000)
Motorola Radios (HT1250, HT750, GPSeries)
Kenwood Radios (TK280, 290, 380, 390)



Item
6R1-AP414
6R1-AP419
6R1-AP484

VISIT US ONLINE

Find more communications equipment and accessories online at:
galls.com/communications-radios-gps

Ordering online? Use your **PROMOTIONAL CODE** from the back cover

800.477.7766 • galls.com

219

Keep Organized with StreetPro™ Gear Bags

Customer Favorite



\$39⁹⁹



Galls® StreetPro™ Gear Bag

The original "go-to" gear bag is priced to meet everyone's budget.

- 900 denier nylon
- Large interior compartment includes an adjustable divider to customize the bag to fit your specific needs
- 2 zipper pouches and 6 pen-and-pencil slots inside
- ID insert
- VELCRO® brand baton holder
- 5 exterior pockets: 3 open-top and 2 zippered on each end

Black. 12½"H x 18½"W x 7½"D. 1,734 cu in

6R1-BG006 \$39.99

ID Your Bag FAST



Galls® StreetPro™ Customizable Gear Bag

All the amazing features of our best-selling StreetPro Gear Bag, with the added benefit of a customizable top for fast, easy identification.

- 900 denier nylon
- Large interior compartment includes reinforced walls and an adjustable divider
- 2 side zippered exterior cargo pockets, 3 large exterior open-top pockets and 2 medium interior zippered pockets
- ID insert
- Secretary organizer on inside of zip-off top
- Nylon web handles
- Adjustable shoulder strap
- VELCRO® brand baton holder on top

Black. 12"H x 18½"W x 7½"D. 1,665 cu in

For bag customization options, visit galls.com/pages/customization

6R1-BG623 \$53.29

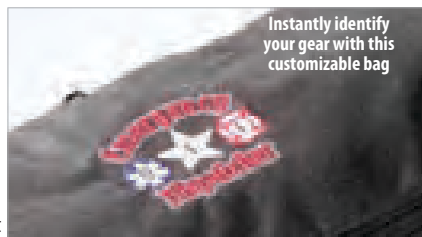

Instantly identify your gear with this customizable bag

More Storage



Galls® StreetPro™ Plus Gear Bag

When your duties require hauling around lots of gear, choose the StreetPro Plus. Designed with a hidden storage flap, baton holder, ID insert, removable hard panels, accessory pouch, VELCRO® brand closure, three pen/pencil slots and mini light holder.

- 900 denier nylon
- 5 exterior pockets — front center bellow with VELCRO® brand flap, 2 open-top, 2 zippered side
- Waterproof bottom

Black. 13½"H x 23"W x 10½"D. 3,260 cu in

6R1-BG185 \$69.39

Understanding Bag Measurements

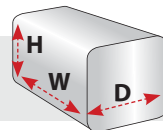



5.11

5.11® Patrol Ready Gear Bag

Built to organize your duty gear and make it immediately available whenever you need it.

- Water resistant
- Rugged outer nylon shell
- 5 gear-sized exterior pockets hold your flashlight, nightstick, glasses, maps and radio

Black. 12"H x 18½"W x 8"D. 1,776 cu in

6R1-BG237 \$49.99



Large inside compartments and pockets hold plenty of gear

For more organization options, shop vehicle consoles starting on p. 261



5.11

5.11® Wingman Patrol Bag

Secures to your passenger seat with a seat belt pass-through. All your essentials will be secure and within easy reach.

- 1200 denier polyester construction
- Loaded with internal and external web platforms and Back-Up Belt System™ panels
- WriteBar™ on the outside of the bag so you can write your name or other identifier on it
- MOLLE webbing on outside to allow you to attach MOLLE system pouches and accessories

Black. 13¼"H x 18½"W x 7½"D. 1,838 cu in

6R1-BG395 \$89.99



Loaded with web platforms



Bag secures to your seat with your passenger seat belt



Galls® StreetPro™ Premium Organizer

Designed to ride in the passenger seat for the greatest accessibility to all your gear.

- 600 denier nylon
- 1 zipper pouch, 3 pen or pencil slots, flashlight holder and nylon webbing
- 2 hanging file folder inserts inside bag
- VELCRO® brand baton holder on top of bag
- Hook-and-loop closure pouch on outside of bag

Black. 14"H x 21"W x 12"D. 3,528 cu in

6R1-BG545 \$106.59

Small Tactical Organizer MOLLE Bag
6¼"H x 5½"W x 2"D **6R1-BG549 \$9.69**



BG549



Attaches to headrest and secured with seat belt



Two hard dividers inside bag to organize file folders



Easy access and convenient storage to all your gear



BG545

Bags For The Office



NEW

**EXCLUSIVE
ITEMS**



Each packs into a compact 8" H x 7" W x 1" D pouch

★ **PROPPER™**

PROPPER™ Packable Backpack

Stores in its own built-in pouch for compact storage until you need it.

- Durable polyester micro ripstop nylon construction
- DWR (durable water repellent) finish
- Two zippered pockets allow for ample storage
- Stuffs into its own zippered pocket for easy transport or storage

Colors: Black, Coyote Tan, Olive Green.
8" H x 7" W x 1" D packed, 18" H x 11" W x 5" D unpacked. 990 cu in

6R1-BB178 \$29.99

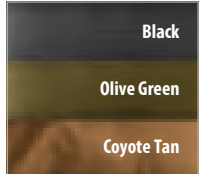

PROPPER™ Packable Duffel

Unpack the duffel from its own built-in pouch and expand to make room for your gear.

- Durable polyester micro ripstop nylon construction
- DWR (durable water repellent) finish
- Large main compartment provides storage for large items
- Two smaller side compartments provide additional organization

Colors: Black, Coyote Tan, Olive Green.
8" H x 7" W x 1" D packed, 13" H x 20" W x 12" D unpacked. 3,120 cu in

6R1-BB176 \$34.99

5.11

Lima
OD Trail



X-Ray
Double Tap Black

Mike
Black

5.11 Tactical® Rush Delivery Bags

5.11 Delivery Bags are ideal for field and office use.

- 1050 and 500 denier water-resistant nylon
- Padded laptop compartment
- Ambidextrous design
- Backup Belt System™ integrated throughout
- Luggage handle attachment
- Non-slip shoulder strap with Duraflex hardware
- YKK® zippers
- Web platforms on front and sides
- Flag/morale patch holder on front
- Back quick-draw, zippered Backup Belt System™ compartment



Description	Dimensions	Volume	Item	Price
Mike	9½" H x 14" W x 3½" D	466 cu in	6R1-BG089	\$89.99
Lima	11" H x 17" W x 5" D	935 cu in	6R1-BG090	\$99.99
X-Ray	12" H x 20" W x 6½" D	1,560 cu in	6R1-BG091	\$109.99

5.11

5.11 Tactical® Side Trip Briefcase

A multi-functional briefcase that can go from laptop case to gear bag.

- 1050 denier textured nylon
- Name-tape holder
- Inside compartment with web platform panel
- Hidden pocket with Backup Belt System™/VELCRO® brand-compatible panel
- Large back pocket with adjustable divider to easily fit a laptop
- Rain cover stowed in bottom for added protection

Black. 12½" H x 16½" W x 5½" D. 1,134 cu in main compartment

6R1-BG342 \$99.99



\$20⁹⁹

Law★Pro™

LawPro® Heavy Duty Canvas Deployment Bag

The deployment bag is one of the largest bags offered for law enforcement and military professionals.

- Heavy-duty brass zippers with cover flap for security
- Heavy-duty 22 oz. canvas
- Full-circle web strap handles for reinforcement

Black. 13" H x 24" W x 15" D. 4,680 cu in.

6R1-BG742 \$21.39



or For The Gym



Under Armour® Undeniable Duffel II

Nearly indestructible, the Undeniable Duffel features UA Storm 1 technology (See p. 154) for a water-resistant application that defeats the elements at all levels. Engineered for toughness, this undeniably combat-worthy duffel can weather any storm.

- Polyester construction
- Abrasion-resistant bottom and side panels
- Large front zippered pocket for organization
- Large vented pocket for laundry or shoes; additional large zippered pocket
- 1 mesh pocket
- Padded top handle for quick grab and carry
- Adjustable, padded, HeatGear® shoulder straps for comfortable transport
- D-ring on front panel

Black. 13"H x 25"W x 11"D. 3,700 cu in

6R1-BB020 \$44.99

Under Armour® Hustle Backpack II Backpack

Engineered for toughness, this backpack can withstand any unanticipated weather while guaranteeing the protection of your essentials.

- Polyester nylon construction
- UA Storm 1 technology (See p. 154) for a superior water-resistant finish
- Soft lined laptop sleeve; holds up to 15" laptop

Black. 18"H x 13"W x 8"D. 1,875 cu in

6R1-BB019 \$54.99



★ PROPPER™

PROPPER™ Tactical Duffel

The perfect companion to carry all your stuff. Customizable with MOLLE compatible webbing on the exterior and an internal loop field within the front and side pockets.

- 1000D Cordura® nylon
- Zippered front pocket with internal loop field, right side pocket with internal loop field
- Left side shoe tunnel expands internally
- Padded adjustable shoulder strap
- Exterior loop field for patches
- Reinforced bottom for increased rigidity
- MOLLE compatible webbing for customization
- Contrast lining provides enhanced visibility
- Durable rubberized handles on either side

Black. For more colors, visit galls.com
12½"H x 23" W x 11"D. 3,162 cu in

6R1-BB321 starting at \$69.99+



Galls® Barrel Bags

Stuff, cram, kick or toss it, and it bounces right back

- Durable polyester material with water-resistant PVC lining
- External flashlight loops
- Reinforced carry handles

Black. Available with custom titles, visit galls.com for details

Original: 19"W x 9½"Dia. 1,295 cu in

6R1-BG140 \$14.99

Deluxe: 26"W x 12"Dia. 3,744 cu in

6R1-BG230 \$21.39



Deluxe



Original



Galls® Square Gear Bag

Great value and space efficiency with this bag. Has large zippered main compartment and front zippered pouch with open pockets on each end.

- 600 denier polyester
- Stiff, sturdy bottom helps retain bag's shape
- Comes with an adjustable and detachable shoulder strap

Black. 10½"H x 18"W x 10"D. 1,890 cu in

6R1-BG051 \$31.99



Galls® Duffel Bags

Water-resistant duffels give you a ton of space for your money.

- 900 denier polyester
- Large internal mesh pocket and front zip storage pocket
- Large heavy-duty zipper and molded ID insert
- Durable rubber cargo handles and padded shoulder strap

Black

6R1-BG186

Description	Dimensions	Volume	Price
Small	9"H x 19"W x 9"D	1,539 cu in	\$26.69
Medium	12"H x 24"W x 11"D	3,168 cu in	\$37.39
Large	14"H x 31"W x 14"D	6,076 cu in	\$47.99

Buy all 3 sizes 6R1-BG187 \$99.99



Visit us online for pricing on additional options.

Range-Ready Gear Bags



\$17⁹⁹

LawPro® Bail Out Bag

This grab-and-go bag features multiple pockets for spare mags and gear.

- 4 front pockets for magazines and other gear
- Adjustable side pockets
- Extra-large back pockets

Black. Main compartment 9½"H x 14"W x 4"D. 532 cu in

6R1-BG115 \$17.99



Galls® Bail-Out Range Bag

Adapts to take on tough gear with adjustable side pockets and extra-large storage.

- 4 front pockets for magazines and other gear
- Adjustable side pockets
- Extra-large back pockets

Black. 9½"H x 14"W x 4"D. 532 cu in

6R1-BG102 \$24.99



Holds 6 AR-15 magazines



Galls® Active Shooter Bag

Be ready in an instant for any active shooter situation with this bag.

- 1000D nylon construction
- Interior lined with loop-sided VELCRO® brand and MOLLE
- Front mag pockets hold up to 6 AR magazines
- Adjustable strap with quick-release

5"H x 15"W x 9"D. 675 cu in

6R1-BG621 \$31.99



LawPro® LAPD Ballistic Nylon "WAR" Bag

A feature-packed tactical bag at an unbeatable price.

- Constructed of durable 1680-denier ballistic nylon
- Large capacity main compartment
- Collapsible helmet compartment expands to store helmet with face shield
- Padded side compartment, ideal for laptop computers
- VELCRO® brand straps for holding a baton or flashlight
- Full-wrap nylon web handles and detachable boomerang shoulder strap

12"H x 36"W x 15"D. 6,480 cu in

6R1-BG743 \$33.19



5.11 Tactical® Bail Out Bag

This bag makes it easy to carry everything you need to successfully deal with active shooter situations.

- 1050D nylon construction
- Back of bag features padded aero-mesh
- Interior is lined with loop-sided VELCRO® brand to attach Backup Belt System™ pouches
- Front mag pockets hold up to 6 AR magazines
- Body-side interior of bag features web platform
- Adjustable strap with quick-release

3"H x 13"W x 9"D. 351 cu in

6R1-BG397 \$59.99

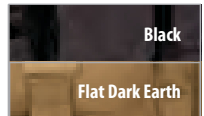

5.11® Range Qualifier Bag

5.11 Range Qualifier Bag is ready for the range.

- 600-denier polyester
- Main front panel includes magazine pockets
- Removable ammo tote
- Bag front drops down flat for a work area

8¾"H x 13"W x 10¼"D.

1,166 cu in

6R1-BG536 \$79.99

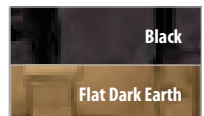

and Packs



Galls® Original RangePro Plus Bag

An all-purpose gear bag with added features specifically designed for shooting supplies and accessories.

- Strong 900 denier polyester
- Large main compartment with adjustable inserts
- Tons of pockets, including large stuffed pockets on and inside the top flap
- Padded curved shoulder strap; handy cargo handles on both ends
- Waterproof bottom

12"H x 26"W x 11"D. 3,432 cu in

6R1-BG188 \$71.99



NEW



Green

Under Armour® Storm Range Backpack Duffel

The Under Armour Storm Range Backpack Duffel can handle everything you need for range day. Features a removable ammo tot that fits directly into the main compartment. A modular panel can be customized to fit your gear.

- Rugged ballistic nylon construction
- Works as both a backpack and a duffel
- UA Storm 1 Technology (See p. 154) delivers an element-battling, highly water-resistant finish
- Tough, abrasion-resistant bottom panel
- Ergonomic foam padded HeatGear® shoulder straps and chest clip
- Compression molded foam back panel for total comfort
- Internal soft lined, padded laptop & tablet sleeve fits up to a 15" laptop
- 2 side end pockets
- Large front pocket with 2 secondary front pockets built in
- Large back pocket with additional vinyl lined pocket
- Large main compartment that zips shut
- Molle style webbing for additional attachment points
- Removable shoulder strap

Colors: Black, Green. 23" x 11" x 11", 3250 cu in

6R1-BB138 \$99.99



Black



Black

NEW

Under Armour® Storm Regiment Backpack

UA Storm 1 Technology (See p. 154) delivers an element-battling, highly water-resistant finish.

- Rugged, ballistic nylon construction
- Tough, abrasion-resistant bottom panel
- Soft lined, padded laptop & tablet sleeve
- Water-repellent front valuables pocket to keep your stuff safe
- Adjustable, padded, HeatGear® shoulder straps for total comfort
- Front chest strap buckles shut to keep backpack snug
- Side-zip water bottle pocket & 2 side buckle organization pockets
- Large, vinyl lined front pocket with sturdy buckle
- Hidden side-zip pocket & a ton of molle webbing for additional attachment points

Colors: Black, Green. 19" x 11" x 7½", 1750 cu in

6R1-BB139 \$89.99



Green



Coyote Tan

TRU-SPEC® TREK Sling Pack

The conventional organization of a backpack with the easy mobility of a shoulder bag.

- Cushioned, adjustable sling strap with front-facing zippered main compartment
- Tablet sleeve and discreet pistol pocket with loop for attachment of holster (not included)
- Perforated foam back
- Loop patch for insignia or patches
- Universal straps for adding and customizing pouches

Colors: Black, Light Gray, Coyote Tan. 12"H x 10½"W x 8"D. 672 cu in

6R1-BB280 \$49.99



Vertex® EDC (Everyday Carry) Bags

Vertex EDC (Everyday Carry) Bags deliver top-of-the-line features in a compact design for optimal concealment. The Cordura® Lite construction for ultimate durability without weight.

Commuter: Sized to fit a 15" laptop in addition to a full-sized handgun. Orbital strap designed for fastest back to front transition.

Colors: Black, Smoke Gray. 20"H x 12"W x 7"D. 1,680 cu in

6R1-BG219 \$169.95





PROPPER™ U.C. Pack

Customization is the core ingredient of the U.C. Pack, inspired by the US Marine Corps Assault pack.

- 1000D Cordura® nylon
- MOLLE webbing covers outside for compatible pouches
- Soft-touch loop lines inside for hook-and-loop items
- Hook-and-loop pass through openings on top for cable port or hydration
- Top and side pockets supplied for smaller gear
- Bottom compartment added for extra storage
- Padded, adjustable shoulder straps
- Alterable sternum strap
- Bottom straps can be cinched to fasten gear in place

23"H x 12½"W x 11"D. 3,162 cu in

6R1-BB300 starting at \$99.99

- Mesh Pouch* **6R1-BB305 \$12.99**
- Reversible Pouch** **6R1-BB312 \$14.99**
- Elastic Organizer Pouch* **6R1-BB318 \$12.99**

*Available in Black

**Available in Black, Coyote, Olive Drab



Black



Black

Coyote

Olive Drab



Mesh Pouch



Reversible Pouch



Elastic Organizer Pouch



PROPPER™ U.C. 2 Pack Assault Kit

Two MOLLE compatible pouches easily attach to Propper's U.C. Pack to expand its carrying capacity.

Colors: Black, Coyote Tan, Olive Drab.

4"H x 11"W x 2"D, 88 cu in. 8"H x 11"W x 2"D, 176 cu in.

6R1-BB220 \$49.99

PROPPER™ Hydration Sleeve

This padded, insulated sleeve holds most three liter reservoirs. Attaches easily to Propper's

Black. 16"H x 8"W x 1"D

6R1-BB221 \$32.99

PROPPER™ Padded Laptop Sleeve

This dedicated padded sleeve easily attaches to Propper's U.C. Pack to safely transport your 15" laptop computer.

Black. 14"H x 10"W x 1"D

6R1-BB222 \$22.99



NEW

Galls® Tactical Backpack

Feature-packed, mission-ready and budget-friendly.

- 600D x 600D polyester
- Compression straps
- Large main compartment with mesh pockets
- Full zip-around pockets
- MOLLE straps and padded articulated back for comfort
- Adjustable and detachable shoulder straps

Colors: Black, Olive Drab, Tan. 17"H x 9"W x 11"D. 1,683 cu in

6R1-BG847 \$51.79



Black

Black

Olive Drab

Tan



5.11 Tactical® Covert 18 Tactical Backpack

Built to blend in, yet go operational at a moment's notice, this is the covert partner you've been looking for.

- 500 denier nylon/420 denier nylon lining and 210 denier nylon
- Hidden, ambidextrous Backup Belt System™ weapons pocket and hidden agenda ID panel
- Pull-down and roll-up tactical outer pocket with web platform

Main Compartment: 19"H x 12½"W x 6½"D.

Front Compartment: 11½"H x 9½"W x 2½"D. 1,800 cu in

6R1-BG533 \$129.99



Black/Asphalt



5.11 Tactical® Rush Packs

Stash survival and emergency basics in any of these functional and water-resistant backpacks, equipped with a compression strap for expandability, hydration pocket for easy water access and a MOLLE-compatible webbing for additional attachments.

- Water-resistant 1050-denier nylon
- Microfleece lined accessory pockets plus internal zippered pockets
- Self-healing YKK® zippers

Rush 72 Pack: Aluminum spine. Colors: Black, Olive Drab, Flat Dark Earth, Sandstone, MultiCam® and Storm. 15"H x 2"W side pockets. 23"H x 14"W x 8"D. 2,576 cu in

6R1-BG351
Solid Colors **\$169.99**
MultiCam® **\$249.99**

Rush 24 Pack: Colors: Black, Olive Drab, Flat Dark Earth, Sandstone and MultiCam®. 13"H side pockets. 20"H x 12"W x 7"D. 1,680 cu in

6R1-BG350
Solid Colors **\$129.99**
MultiCam® **\$169.99**

Rush 12 Pack: Colors: Black, Sandstone and MultiCam®. 18"H x 11"W x 6"D. 1,188 cu in

6R1-BG403
Solid Colors **\$99.99**
MultiCam® **\$139.99**



Rush 72 MultiCam®

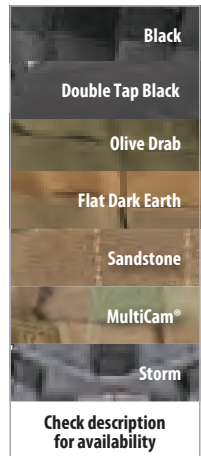

Black

Double Tap Black

Olive Drab

Flat Dark Earth

Sandstone

MultiCam®

Storm

Check description for availability

Keep Your Tactical Gear Ready to Roll



Galls® Crowd Control Bag

No more lugging around your heavy riot gear. Just load it up and wheel it with you. This giant bag can hold it all!

- 900 denier polyester construction
- Waterproof bottom is rigid, with stabilizers for support
- VELCRO® brand straps secure 36" baton outside
- Zippered helmet pouch on one end and a zippered accessory pocket on other
- Front zippered bellow pocket is just right for paperwork
- Leather-wrapped cargo handles on either end
- ID pocket on the end

Black. 19"H x 40"W x 16"D. 12,160 cu in

6R1-BG622 \$117.29



Full wrap-around extension handles with accessible hinge-type lid



One end has padded riot helmet pouch



Sturdy wheels make carrying a heavy load easy



Three-level telescoping handle keeps you from having to bend over when you pull bag along

Galls® StreetPro™ X-Tra Rolling Gear Bag

Roller-blade style wheels and telescoping handle on a large capacity bag makes hauling heavy gear effortless.

- 900 denier polyester
- 1 large padded main compartment that zips; plus 3 more zippered pockets to organize your smaller tools and supplies
- Runners on bottom of bag provide stability when you set it down
- Leather cargo handles
- Carrying strap with leather wrap handles
- ID holder

Black. 14½"H x 29½"W x 14"D. 5,989 cu in

6R1-BG198 \$106.59



5.11

5.11 Tactical® Mission Ready 2.0 Rolling Bag

Offers customizable storage options to keep your gear safe, organized and secure when you are on the go.

- Weather-resistant 1600 denier nylon
- Internal, roll-away dividers and top access allows bag to become top loader
- Fo4ur external pockets
- Reinforced bottom corners and skids
- Write bar, name tape, flag holders and ID window
- Heavy-duty wheels and axle; collapsible handle

Colors: Black, Doubletap Black, Sand. 28¾"H x 15"W x 13"D. 5,606 cu in

6R1-BG639 \$249.99

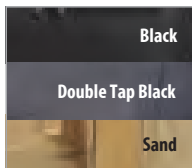

Black



Galls® Tactical Team Bag

Carries riot helmet, shield, upper body protection, elbow and kneepads, and more!

- 900 denier polyester
- Large zippered main compartment
- Carrying handles on top and on ends that make it easy for two people to carry
- Waterproof bottom to help keep gear dry
- Mesh inner lining to help air out and prevent mildew
- VELCRO® brand straps to secure baton

17"H x 36"W x 15"D. 9,180 cu in

6R1-BG135 \$60.79



5.11 

Black



5.11 Tactical® CAMS 2.0 Rolling Bag

The ultimate large deployment bag, the CAMS (Carry All My Stuff) 2.0 can hold it all.

- 1600 denier
- HD oversized wheels and bottom skids
- Rugged corner guards on all corners
- Double self-retracting handles at ends
- Light colored interior for better visibility
- MOLLE/ALICE-compatible interior
- Adjustable inside loop-sided dividers
- Reinforced, rigid ends and bottom
- Lockable YKK® zippers
- Name tape and flag holders
- Markable name strips
- Foot studs with lashing pass-through
- Business card holder and document pocket

Colors: Black, Sand, Doubletap Black.
15"H x 40"W x 15½"D. 9,300 cu in

6R1-BG638 \$329.99

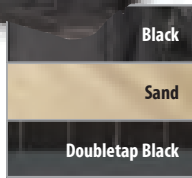

5.11 

Black



5.11 Tactical® SOMS 2.0 Rolling Bag

The SOMS 2.0 (Some Of My Stuff) rolling duffel bag offers a broad range of customizable storage options that keep you organized in any setting.

- 1600 Denier
- HD oversized wheels and bottom skids
- Rugged corner guards on all corners
- Self-retracting grab handles at ends
- Light colored interior
- MOLLE/ALICE-compatible interior panel
- Adjustable inside loop-sided dividers
- Replaceable fiberglass laminate frame
- Reinforced, rigid ends and bottom
- Lockable YKK® zippers
- Name tape and flag holders
- Markable name strips
- Foot studs with lashing pass-through
- Business card holder and document pocket

Colors: Black, Sand, Doubletap Black.
14"H x 32"W x 14½"D. 6,496 cu in

6R1-BG640 \$299.99

NEW



Lite N Write HD Foam Insert

Designed for iPad Air, iPad Mini, tablets, cell phones and other electronics. Customized to fit the patented design of the Lite N Write Clipboard, the insert is secured by tabs that are molded for perfect positioning. Guaranteed not to shrink or stretch, the HD Foam Insert will keep your tablet firmly in place.

- Snug fit for outstanding shock absorption
- Holds its shape; will not absorb water or humidity
- Easy access thumb point for quick removal of tablet, as well as access to the on/off button
- Imported

Black

6R1-CP125 \$39.95



Lite N Write Clipboard and Light Hawk Pro Citation Holder Combo

Keeps all of your reports and forms together in one convenient package! The innovative Lite N Write Clipboard and Light Hawk Pro Citation Holder come together to make your job easier and ultra-efficient. Attaching to each other with VELCRO® brand strips, both the clipboard and the citation holder feature a light bridge with 4 LEDs, eliminating the need for additional lighting. Combo includes:

- Lite N Write Clipboard (CP040)
- Light Hawk Pro Citation Holder (CP099)

6R1-CP102 \$74.89 SAVE \$9.55
\$84.44 if purchased separately

Lite N Write Clipboard: Durable, water-resistant polypropylene construction features a locking clip to protect contents in any weather. Removable light bridge includes 4 LEDs to illuminate the entire surface. Black. 14"L x 9"W x 2"D

6R1-CP040 \$29.95

Light Hawk Pro Citation Holder with Light Bridge: Innovative tri-fold design with light bridge allows you to carry all the tickets you need in one compact package and eliminates the need for additional lighting. Features 4 ultra-bright LEDs to illuminate the entire surface. Black. 5½"W x 12½"L

6R1-CP099 \$54.49



Pelican™ Waterproof Cases

World's toughest watertight equipment cases.

- Lightweight structural foam resin construction
- Watertight O-ring seals
- Atmospheric purge valves
- Impervious to dents, scratches or corrosion
- Pre-scored foam sections allow custom fit
- Double action latches
- Meets or exceeds the highest standards for airline, commercial, US government, industrial, and US military use

Colors: (BG083/BG084)Black, Desert, Olive Drab, Orange, Silver, Yellow. (BG012) Black, Desert, Orange, Silver. (BG013) Black, Desert, Orange, Silver, Yellow

Size	Item	Price
9¾"H x 10¾"W x 4¾"D, 498 cu in	6R1-BG012	\$69.99
11¾"H x 13¾"W x 6"D, 931, cu in	6R1-BG083	\$122.99
14¾"H x 18½"W x 6¾"D, 1683 cu in	6R1-BG084	\$189.99
24¼"H x 19¾"W x 8¼"D, 3978 cu in	6R1-BG013	\$274.99



Check descriptions for availability



Galls® Citation Holder

Adjusts to any size citation form up to 6¼" x 11". Citation Holder has a ¾" storage compartment with a plastic divider that adjusts, eliminating the need for separate holders.

- Heavy-duty aluminum
- High-capacity clip with swivel license holder
- VELCRO® brand wraparound strip secures entire unit
- Top-opening

11½"H x 6½"W x 2¼"D. Customization is available, call for details

6R1-CP093 \$20.99



Swivel license holder frees up your hands

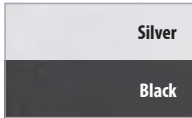

Only 1¼" in depth!



Galls® Slimline "A" Style Letter Size Report Holder

Compact clipboard is easy to store and easy to take out when needed.

- Smooth aluminum writing surface with heavy-duty spring clip
- Low-profile design
- Swivel clip holds license
- Inside storage spaces for your papers, paper clips and pens

12¾"H x 9¾"W x 1¼"D. Customization is available, call for details

6R1-CP003 \$29.99

VISIT US ONLINE

Order Easily Online

For a huge selection of uniforms, footwear, gear and brands, visit galls.com.

Top-opening



Galls® StreetPro™ Clipboards

Carry all your necessary forms and supplies with two built-in storage compartments.

- Durable recycled aluminum construction
- Low-profile clip
- Self-locking latch keeps the compartment securely fastened

Top-opening: letter (14"H x 9"W x 2"D) or legal (16"H x 9"W x 2"D).

Side-open: 15"H x 9¾"W x 2¾"D.

Customization is available, call for details

Opening	Paper Size	Item	Price
Top	Letter	6R1-CP091	\$33.19
Top	Legal	6R1-CP092	\$33.19
Side	Letter	6R1-CP094	\$37.99



Side-opening style (letter size only)

Black

Silver



Posse Form Holder

Keep your forms protected and accessible.

- Lightweight, non-reflective hard anodized aluminum
- Compact storage for extra cite book, cheat sheet and completed copies
- Quick-opening front allows rapid handling of citations
- Built-in drivers license holder behind clip
- Made in the USA

12½"H x 4½"W x 1½"D. Colors: Silver Anodized or Black Vinyl Coated

6R1-CP060 \$23.39+

Black

Silver

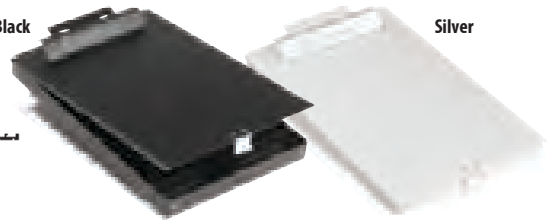

Posse Box Jr

A compact size Bottom-opening version of the Posse Box

- Bottom-opening style
- Lightweight, non-reflective hard anodized aluminum
- Made in the USA

14"H x 9"W x 1"D. Colors: Silver Anodized or Black Vinyl Coated

6R1-CP074 \$27.39+

Black

Silver

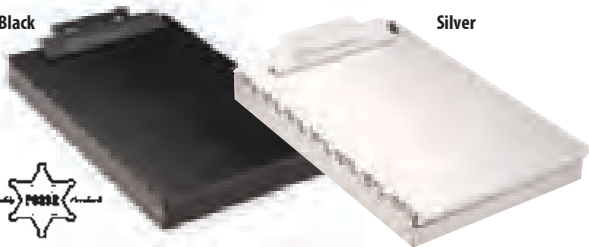

Posse Side Opening Box

Patented grip clip secures your pen and holds up to 1 inch of paper. Includes two storage compartments with a self locking latch.

- Side opening style
- Patented grip clip secures your pen and holds up to 1 inch of paper
- Two storage compartment with self locking hatch
- Made in the USA

9¼"H x 4"W x 1½"D. Colors: Silver Anodized or Black Vinyl Coated

6R1-CP082 \$30.49+

Black

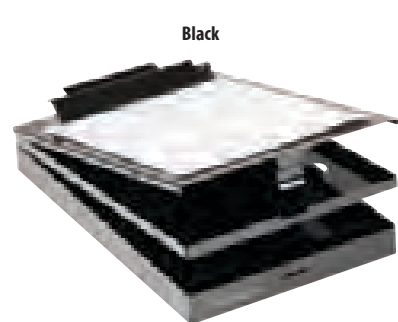

Posse Bottom Opening Box

Features two storage compartments with a self locking latch. Patented grip clip secures your pen and holds up to 1 inch of paper.

- Bottom opening style
- Patented grip clip secures your pen and holds up to 1 inch of paper
- Two storage compartment with self locking hatch
- Made in the USA

9¼"H x 4"W x 1½"D. Colors: Silver Anodized or Black Vinyl Coated

6R1-CP033 \$30.49



Visit us online for pricing on additional options.

Ordering online? Use your **PROMOTIONAL CODE** from the back cover

800.477.7766 • galls.com

229

First Responder Kit Options Made Easy

First Responders told us the basic items they want in a kit — the Original Kit. We responded! You have a choice of kit contents as well as bag preference. Get the original First Responder Kit, or the Deluxe First Responder Kit for only \$10 more.

SAVE with Complete Kit Packages

SAVE OVER \$54 when you buy a complete kit compared to purchasing your bag and supplies separately. In addition, a complete kit also makes your shopping easier — save time and get everything you need delivered quickly. We also sell refill kits of consumable items for when your supplies run low.

Customize Your Kit Contents

We can customize kit contents to fit your needs. Call us today for more details.

First Responder Kit Contents



Deluxe First Responder Kit Contents



First Responder Kit Supplies

	First Responder Kit	First Responder Kit Refill	Deluxe First Responder Kit	Deluxe First Responder Kit Refill
AIRWAY				
CPR Microshield	1	1	-	-
CPR Mask	-	-	1	1
BURN				
Burn Pad (4" x 4")	1	1	1	1
DRESSINGS & BANDAGES				
Bandages (1" x 3")	16	16	16	16
Abdominal Pad (5" x 9")	2	2	2	2
Trauma Dressing (12" x 30")	1	1	1	1
PVP Iodine Wipes	10	10	10	10
Elastic Bandage (4")	1	1	1	1
Gauze Pads (4" x 4")	20	20	20	20
Gauze Pads (3" x 3")	10	10	10	10
Blood Stopper	2	2	2	2
Gauze Roll (4")	2	2	2	2
Gauze Roll (3")	2	2	2	2
Alcohol Wipes	10	10	10	10
Antimicrobial Wipes	10	10	10	10
Waterproof Tape (1")	1	1	1	1
Waterproof Tape (1/2")	1	1	1	1
Elastic Bandage (3")	1	1	1	1
Triangular Bandages	2	2	2	2
Eye Pads	4	4	4	4
Kerlix (4 1/2")	2	2	2	2
Antibiotic Ointment (.5g)	10	10	10	10
EQUIPMENT & SUPPLIES				
Small Cold Packs	2	2	2	2
Space Blanket	1	1	1	1
Pair Nitrile Gloves	10	10	10	10
Eye Wash (4 oz)	1	1	1	1
BP/Stethoscope	1	-	1	-
SAM Splint	-	-	1	1
Mini Mag Flashlight	-	-	1	-
First Aid Booklet	1	1	1	1
Instrument Pack	1	-	1	-

Kits Packed with First



Compact Medic First Responder Kit
Navy



Briefcase-Style with Carry Handle

Subdued Black

Navy



Dyna Med® Compact Medic First Responder Kits

This kit combines the space-saving, briefcase-style Compact Medic bag with the First Responder supply package of your choice.

- Durable nylon exterior
- 12 interior pockets; 1 large interior pocket ideal for BP kits
- Loops of many sizes to keep supplies organized

8"H x 14"W x 3 1/2"D. 392 cu in

Kit	Item	Price	Price if bag & contents purchased separately	SAVE
First Resp.	6R1-TK095	\$117.29	\$146.73	\$29.44
Deluxe	6R1-TK080	\$127.89	\$170.61	\$42.72
Bag Only	6R1-BG177	\$27.69		
Kit Refill	6R1-TK093	\$66.39		
Deluxe Kit Refill	6R1-TK088	\$75.99		



Dyna Med® Combines Quality and Value

Our private-label brand, Dyna Med, has been trusted by first responders for more than 45 years. With products ranging from complete kits to spine boards to our popular Hare Splint, Dyna Med products equip you to treat patients safely and affordably.



Dyna Med® Hydro Series Waterproof First Responder Kits

Hydro Series First Responder kits offer great versatile style and features along with durable high performance waterproof finish.

- Waterproof Durable 1000 Denier PVC Tarpaulin finish
- Internal adjustable divider system
- Heavy duty rubber feet to protect the bottom of the bag
- Shoulder strap and heavy duty handle
- Full-length front pocket

7"H x 16"W x 8"D. 896 cu in



Blue

Red

Blue

Kit	Item	Price	Price if bag & contents purchased separately	SAVE
First Resp.	6R1-TK166	\$195.99	\$227.73	\$31.74
Deluxe	6R1-TK167	\$206.79	\$251.61	\$44.82
Bag Only	6R1-MB065	\$105.59		
Kit Refill	6R1-TK093	\$66.39		
Deluxe Kit Refill	6R1-TK088	\$75.99		

Responder Essentials



Deluxe Mini-Medic First Responder Kit
Red



Navy

Subdued Black

Navy

Orange

Red



Convenient, compact size



Dyna Med® Mini-Medic First Responder Kits

Kit includes versatile bag with a carrying handle and shoulder strap; perfect for hands-free transport of your First Responder medical supplies.

- 1000 denier nylon with a waterproof bottom
- 3 adjustable inner compartments; 2 front and 2 side pockets
- Elastic loops on inside of lid

7½"H x 13"W x 7¼"D. 707 cu in

Kit	Item	Price	Price if bag & contents purchased separately	SAVE
First Resp.	6R1-TK094	\$120.79	\$159.53	\$38.64
Deluxe	6R1-TK079	\$131.29	\$183.41	\$52.12
Bag Only	6R1-MB060	\$42.69		
Kit Refill	6R1-TK093	\$66.39		
Deluxe Kit Refill	6R1-TK088	\$75.99		

Deluxe Medic Backpack First Responder Kit
Red

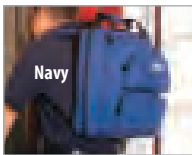

Navy

Hideaway Backpack Straps

Bag lays flat for a full view when opened



Dyna Med® Medic Backpack First Responder Kits

This kit features a versatile, lightweight bag and your choice of First Responder supplies.

- 1000 denier nylon
- 7 internal pockets; 1 external pocket for hideaway backpack straps
- 24 internal elastic loops

16"H x 12"W x 5½"D. 2,976 cu in

Kit	Item	Price	Price if bag & contents purchased separately	SAVE
First Resp.	6R1-TK096	\$140.49	\$182.73	\$44.34
Deluxe	6R1-TK081	\$152.29	\$206.61	\$54.32
Backpack Only	6R1-MB027	\$63.99		
Kit Refill	6R1-TK093	\$66.39		
Deluxe Kit Refill	6R1-TK088	\$75.99		

Includes Essential First Responder Supplies



ELITE FIRST AID, INC.

Elite First Aid Rapid Response First Aid Bag

This kit was custom designed by request of Elite military units desiring a more compact & light kit for their daily field operations.

- M.O.L.L.E. Straps with snaps at one end to attach to a belt up to 5" wide
- Can be worn in any other location with additional Alice clips (not included)
- Light weight quality designed bag with multiple compartments

Colors: Olive Drab, Black, Dark Tan & Army Combat Uniform. 11" x 6" x 6½"
Visit galls.com for kit contents

6R1-TK190 \$50.79



Trauma Kit 3 Includes Essential Tactical Trauma Supplies



ELITE FIRST AID, INC.

Elite First Aid Tactical Trauma Kit 3

The Tactical Trauma Kit #3 features a rugged backpack with a lot of compartments for easy access to the contents. This backpack is designed and used by professionals, and is very comfortable to wear.

- Designed by tactical professionals
- Multiple compartments for organization and easy access
- Includes EFA first aid book

Colors: Olive Drab, Black, Coyote Tan, Army Combat Uniform, Red, Multicam. 18" x 10" x 11" 1900 cu in. Visit galls.com for kit contents

6R1-TK179 \$207.99



Designed by Tactical Professionals

Understanding Bag Measurements

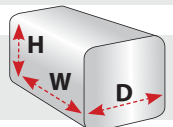

Medical Kits.....	230
First Aid Supplies.....	242
Immobilization.....	246

Medical Gloves.....	248
Turnout & Extrication.....	250
Bags.....	251

Fire Boots.....	252
Rescue Tools.....	254
Fire & Extrication Gloves.....	256

SAVE with BLS Kits

Pick the kit contents that best fit your needs, choose the type of bag that you prefer and **SAVE** money buying a kit! Choose between the BLS kit with all the essentials you need, including one of six bag choices, or step up to the "Deluxe" kit which has seven additional items and four bag options. Refill kits are also available to replace your consumable supplies – all at great savings over buying individual items separately.

Customize Your Kit Contents

We can customize kit contents to fit your needs. Call us today for more details.

BLS Complete Kit Contents

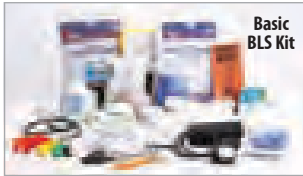

Basic
BLS Kit



Deluxe
BLS Kit

	BLS Kit	BLS Kit Refill	Deluxe BLS Kit	Deluxe BLS Kit Refill
AIRWAY				
CPR Mask	1	1	1	1
Bag Valve Mask	-	-	1	1
Berman Airway Kit	1	1	-	-
Airway Kit 22-32 Fr	-	-	1	1
BURN				
Burn Sheet	1	1	1	1
Burn Pad (4" x 4")	1	1	1	1
DRESSINGS & BANDAGES				
Bandages (1" x 3")	16	16	16	16
Abdominal Pad (5"X 9")	2	2	2	2
Trauma Dressing (12" x 30")	1	1	1	1
Gauze Pads (3" x 3")	10	10	10	10
Gauze Pads (4" x 4")	20	20	20	20
Blood Stopper	2	2	2	2
Gauze Roll (4")	2	2	2	2
Gauze Roll (3")	2	2	2	2
PVP Iodine Wipes	10	10	10	10
Alcohol Wipes	10	10	10	10
Antimicrobial Wipes	10	10	10	10
Waterproof Tape (1")	1	1	1	1
Waterproof Tape (½")	1	1	1	1
Elastic Bandage (3")	1	1	1	1
Elastic Bandage (4")	1	1	1	1
Triangular Bandages	2	2	2	2
Eye Pads	4	4	4	4
Kerlix (4½")	2	2	2	2
Petroleum Gauze (3" x 9")	1	1	1	1
Antibiotic Ointment (.5 g)	10	10	10	10
EQUIPMENT & SUPPLIES				
First Aid Booklet	1	1	1	1
Small Cold Packs	2	2	2	2
Disposable Foam Blanket	1	1	1	1
Space Blanket	1	1	1	1
Ammonia Inhalants	-	-	10	10
Sting and Bite Swab Kit	10	10	10	10
Insta-Glucose (31 g)	-	-	1	1
Activated Charcoal	-	-	1	1
Cervical Collar	-	-	1	1
OB Kit	-	-	1	1
Personal Protection Kit	-	-	1	1
Pair Nitrile Gloves	10	10	10	10
Eye Wash (4 oz)	1	1	1	1
SAM Splint (4" x 9")	1	1	-	-
SAM Splint (4" x 36")	-	-	1	1
Mini Mag Flashlight	1	-	1	-
BP/Stethoscope	1	-	1	-
Instrument Pack	1	-	1	-

Respond Rapidly

DYNAMED



Navy



Red



11 Interior Compartments

Dyna Med® Maxi-Medic BLS Kit

Versatility allows for better organization of supplies.

- 1000 denier nylon bag; waterproof bottom
- 2 zippered outside compartments for bulkier items
- Mesh pouch on lid accommodates smaller items

9"H x 19½"W x 12"D. 2,073 cu in

Kit	Item	Price	Price if bag & contents purchased separately	SAVE
BLS	6R1-TK082	\$219.99	\$265.28	\$45.29
Bag Only	6R1-BG087	\$89.29		
Kit Refill	6R1-TK089	\$111.99		

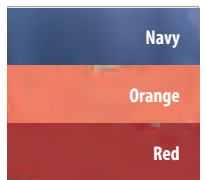

5.11



BLS



Oxygen tank tunnel



Removable stadium organization with mesh top panels

5.11® BLS Kits

Two exterior padded pockets with removable dividers, plus removable and heavy-duty honeycomb PVC oxygen tank tunnel.

- Water-resistant 1050D nylon, DWR finish
- Write bars on main bag and all internal bags
- Fully adjustable shoulder strap system

Royal Blue. 11"H x 24½"W x 15"D. 4,043 cu in

Kit	Item	Price	Price if bag & contents purchased separately	SAVE
BLS	6R1-TK105	\$367.39	\$400.88	\$33.49
Deluxe	6R1-TK106	\$428.39	\$558.00	\$129.61
Bag Only	6R1-BG423	\$199.99		
Kit Refill	6R1-TK089	\$111.99		
Deluxe Kit Refill	6R1-TK090	\$175.89		



with BLS Kits



DYNAMED



Equipped with five color-coded modules

Dyna Med® Modular Trauma III BLS Kit

Five color-coded modules and plenty of pockets for convenience.

- 1000 denier nylon bag with 1 large lid pocket and 3 outside side pockets
- Waterproof bottom
- Side walls are foam filled for protection and support
- D-rings secure bag to vehicle or helicopter surface

Orange. 15"H x 18"W x 9"D. 2,430 cu in

Kit	Item	Price	Price if bag & contents purchased separately	SAVE
BLS	6R1-TK083	\$241.49	\$284.88	\$43.39
Bag Only	6R1-MB028	\$111.99		
Kit Refill	6R1-TK089	\$111.99		



Deluxe BLS
Orange

DYNAMED



Red

Dyna Med® Mega-Medic™ BLS Kits

Added versatility comes with this larger-sized bag.

- 1000 denier nylon bag
- Waterproof bottom
- 11 interior compartments, 2 outer compartments, 2 mesh pockets on lid

11"H x 22"W x 14"D. 3,388 cu. in

Kit	Item	Price	Price if bag & contents purchased separately	SAVE
BLS	6R1-TK154	\$239.89	\$286.78	\$46.89
Deluxe BLS	6R1-TK085	\$314.99	\$444.30	\$125.31
Bag Only	6R1-BG169	\$110.29		
Kit Refill	6R1-TK089	\$111.99		
Deluxe BLS Kit Refill	6R1-TK090	\$175.89		

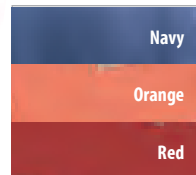

Red



Oxygen tank tunnel for ALS use

Meret® OMNI Pro BLS Kit

The Meret Omni Pro Kit has many features to allow you to create an organized bag that meets any requirement.

- Durable 1680/1200 denier coated TPE, water and stain resistant
- Oversized YKK® zippers with large EZ-Pulls allow easy access
- Carry with shoulder strap, large top handle, COMFORT-GRIP handles on sides of bag or hideaway backpack straps
- Internal main compartment using SLIDERS™ System
- Hideaway zippers allow optional modules to be attached to the OMNI™ PRO bag

15"H x 21"W x 9½"D. 2,993 cu in

Kit	Item	Price	Price if bag & contents purchased separately	SAVE
BLS	6R1-TK160	\$387.99	\$490.57	\$102.58
Bag Only	6R1-BG598	\$299.99		
Kit Refill	6R1-TK089	\$111.99		

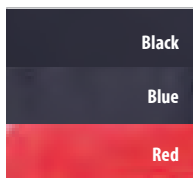

BLS
Royal Blue

Iron Duck® Ultra Sofbox Plus BLS Kit

The Iron Duck Ultra Sofbox Plus is the most versatile of the small ALS/BLS bags.

- Full length front pocket
- Dual YKK® reverse-coil zippers open on a full length pouch
- Multiple packets and pouches
- Poly pro handles and adjustable sling style shoulder strap

12"H x 22"W x 14"D. 1,221 cu in

Kit	Item	Price	Price if bag & contents purchased separately	SAVE
BLS	6R1-TK146	\$440.39	\$520.57	\$80.18
Deluxe	6R1-TK147	\$530.99	\$677.69	\$146.70
Bag Only	6R1-BG585	\$334.99		
Kit Refill	6R1-TK089	\$111.99		
Deluxe Kit Refill	6R1-TK090	\$175.89		

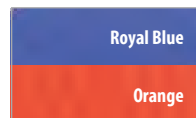

Ordering online? Use your **PROMOTIONAL CODE** from the back cover

800.477.7766 • galls.com

233

Choose the Bag for Your ALS Access Supplies!

The ALS Kit includes everything you need to provide minimal first aid, care for critical injuries or provide advanced life support at the scene. Available in your choice of medical bags!

Customize Your Kit Contents

We can customize kit contents to fit your needs. Call us today for more details.



ALS Complete Kit Contents

	ALS Kit	ALS Kit Refill
AIRWAY		
CPR Mask	1	1
Bag Valve Mask	1	-
B & F Non Breather Mask	2	-
B & F Nasal Cannula	2	-
Berman Airway Kit	2	1
BURN		
Burn Sheet	1	1
DRESSINGS & BANDAGES		
Bandages (1" x 3")	16	16
Abdominal Pad (5" x 9")	2	2
Trauma Dressing (12" x 30")	1	1
Gauze Pads (3" x 3")	10	10
Gauze Pads (4" x 4")	20	20
Blood Stopper	2	2
Gauze Roll (4")	2	2
Gauze Roll (3")	2	2
PVP Iodine Wipes	10	10
Alcohol Wipes	10	10
Antimicrobial Wipes	10	10
Waterproof Tape (1")	1	1
Waterproof Tape (1/2")	1	1
Elastic Bandage (3")	1	1
Elastic Bandage (4")	1	1
Triangular Bandages	2	2
Eye Pads	4	4
Kerlix (4 1/2")	2	2
Petroleum Gauze (3" x 9")	1	1
Antibiotic Ointment (.5g)	10	10
EQUIPMENT & SUPPLIES		
First Aid Booklet	1	1
Small Cold Packs	2	2
Disposable Foam Blanket	-	1
Space Blanket	1	1
Sting And Bite Swab Kit	10	10
OB Kit	-	-
Pair Nitrile Gloves	10	10
BP/Stethoscope	1	-
D Oxygen Cylinder	1	-
Dyna Flo Brass Regulator	1	-
Instrument Pack	1	-

Questions?

Our customer service representatives are here to help you Monday-Friday 8:00 a.m. - 9:00 p.m. ET. Call 800.477.7766 today to place an order, ask a question or learn more about our products.



Dyna Med® Trauma ALS Kit

1000 denier nylon trauma bag features a removable shelf, allowing for O2 supplies to be placed on the top of the tank for greater access.

- Padded O2 compartment
- Waterproof bottom

Green with color coded inner bags. 9"H x 22"W x 14"D. 2,772 cu in



Kit	Item	Price	Price if bag & contents purchased separately	SAVE
ALS	6R1-TK097	\$403.99	\$524.84	\$120.85
Bag Only	6R1-BG146	\$157.49		
Kit Refill	6R1-TK089	\$111.99		



Dyna Med® Hydro Series Waterproof ALS Kit

Offers great versatile style and features along with durable high performance, waterproof finish.

- Waterproof Durable 1000 Denier PVC Tarpaulin finish
- Internal adjustable divider system
- Heavy duty rubber feet to protect the bottom of the bag
- Shoulder strap and heavy duty handle
- Front and side pockets; O2 compartment with protective sleeve

Green. 12"H x 24"W x 15"D. 4,320 cu in



Waterproof PVC Finish

Kit	Item	Price	Price if bag & contents purchased separately	SAVE
ALS	6R1-TK168	\$487.69	\$553.26	\$65.57
Bag Only	6R1-MB067	\$184.69		
Kit Refill	6R1-TK089	\$111.99		



5.11

5.11® Backpack ALS Kit

Four compression straps secure helmet, boots and other odd-shaped gear, plus tons of pockets to fit all of your work essentials!

- 1050D nylon, Durable Water Resistant finish
- Adjustable Oxygen tank seat and cuff
- Hydration system-compatible (100 oz)
- 12 front pockets, organizer slots; back panel interior pocket

Royal Blue. 24 1/4"H x 16 1/4"W x 15 1/2"D. 4,138 cu in



Royal Blue

Kit	Item	Price	Price if bag & contents purchased separately	SAVE
ALS	6R1-TK108	\$514.49	\$639.49	\$125.00
Bag Only	6R1-BG424	\$229.99		
Kit Refill	6R1-TK089	\$111.99		

Administer Advanced Life Support



Dyna Med® Oxygen Delivery Kit

Features round oxygen bag with reflective striping for added safety.

- Regulator NIOSH and FDA recommended
- 6 interior pockets for sorting equipment
- Includes strap for securing tank
- Waterproof bottom and padded flap to protect regulator

Green. 10"H x 20"W x 17"D. 3,060 cu in

6R1-RK042 \$340.99

Bag Only **6R1-BG144 \$86.79**



Dyna Med® Dyna Flo Brass Regulator

The lightweight brass construction offers safety while maintaining a professional appearance.

- Provides regulated pressure (40-60 psi) and flow (100 LPM minimum)
- Barbed flow outlet
- Selector knob with 12 click-stop positions (0, 1, 2, 4, 6, 8, 10, 12, 15, 18, 20, 25 LPM)

Made in the U.S.A. 1.75 lbs

6R1-RO1058 \$132.79



Allied Healthcare Products, Inc.

Allied Healthcare Products Aluminum D O2 Cylinder

Exclusive on/off toggle handle post valve, no wrench needed.

- Toggle unit easily removed
- 415 liters at 2,000 lbs psi (6 lbs)

Made in the U.S.A. Cylinders supplied unfilled

6R1-RO847 \$75.52



Oxygen Delivery Bag and Kit Contents:

- | | |
|-----------------------------------|-------------------------------|
| 1 Dyna Flo Brass Regulator | 1 B and F Nasal Cannula Adult |
| 1 D Oxygen Cylinder | 1 Colored Berman Airway kit |
| 1 B and F Adult Non Breather Mask | |

Plano® Small First Responder Bag

This compact first responder bag features modular organizers to give emergency responders fast and efficient access to critical medical supplies.

- Water-resistant 1680D nylon construction
- Waterproof, impact-resistant molded bottom is durable and easily cleaned
- Molded top accommodates a StowAway® Organizer
- 12 pockets and compartments provide storage for essential gear
- 3 exterior pockets and easy-access glove pocket dispenses gloves instantly
- Includes 5 3600 Series StowAway® Organizers
- Comfortable, molded plastic handle comes apart for fast access to medical gear
- Reflective striping for improved visibility

Orange. 13"H x 9"W x 8 1/4"D. 965cu in

6R1-MB019 \$111.59

Large First Responder Bag **5K3-MB020 \$131.99**



Plano® Medical Bag

Designed to give first responders everything they need to efficiently handle medical emergencies.

- Water-resistant 1680 denier nylon construction
- Molded plastic bottom increases durability and makes cleaning easy
- 3 external pockets and one quick-release pocket allows
- Easy access glove pocket on lid

Orange. 9 1/2" H x 23" W x 18 1/2"D. 4,042 cu in

6R1-MB014 \$233.49

Oxygen Medical Bag **6R1-MB017 \$233.49**

Trauma Medical Bag **6R1-MB016 \$304.49**



Iron Duck Breath Saver D Airway Management Bag

The original and most popular airway management bag in the industry.

- Padded with high density foam
- Padded handles and ergonomic shoulder strap
- Main compartment features hook and loop tank anchors for D or Jumbo D tanks
- Interior features numerous mesh pockets and adjustable hook and loop holders
- Full length zippered side pockets on the front and back

Colors: Green, Orange, Royal Blue, Red.

10"H x 27"W x 12"D. 3,240 cu in

6R1-BG584 \$221.99



Iron Duck® Oxygen Bag with Pocket

Classic cylindrical design for fast deployment of a D or Jumbo D tank, regulator and accessories. Single exterior side pocket runs the length of the front side. Inside, a padded nozzle protector and adjustable hook and loop tie-downs secure the tank.

- 400D Nylon inner
- Fully lined with closed-cell foam
- Four Mesh Pockets
- YKK® zippers
- Removable, sling-style shoulder strap with non-slip molded rubber pad
- Carrying handles

Colors: Green, Red.

8 1/2"H x 21"W x 11 1/2"D. 1990 cu in

6R1-BG583 \$162.99



Green

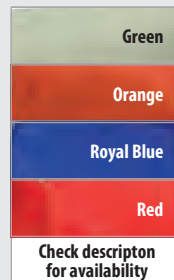

Check descriptor for availability



Red

Control Bleeding with Tactical Trauma Kits

In October 2015, the President announced an initiative from the National Security Council to "Stop the Bleed". Our Dyna Med® Personal Bleeding Control Kits contain the essential medical supplies required to save a life in the event of immediate, life threatening bleeding. Assembled with the highest quality components, these kits allow responders and bystanders to deliver lifesaving first aid in the event of a disaster.



Dyna Med® Personal Bleeding Control Kits

These kits include a tourniquet, trauma dressing, gauze, shears and medical gloves, all conveniently packaged in a compact nylon pouch. An excellent addition to any family medical kit, emergency preparedness kit or first responder kit.

- C-A-T Combat Application Tourniquet (TK225) is tested by the U.S. Army Institute of Surgical Research to be 100% effective in stopping blood flow in both the arms and legs
- SOF Tactical Tourniquet (TK226) is used by the world's elite operators for its dependability and ease of application
- SWAT-T Tourniquet™ (TK227) is a unique and multipurpose dressing; its name provides a description for usage — Stretch, Wrap and Tuck — but also the communities for whom it was developed, military and tactics teams

Black. Open: 37½" L. 21 oz

Description	Item	Price
Kit w/ C-A-T	6R1-TK225	\$70.99
Kit w/ SOF-T	6R1-TK226	\$70.99
Kit w/ SWAT-T	6R1-TK227	\$55.89
C-A-T Tourniquet	6R1-FA240	\$31.99
SOF-T Tourniquet	6R1-FA109	\$45.39
SWAT-T Tourniquet	6R1-FA181	\$16.29



Kit w/C-A-T



Kit w/SOF-T



Kit w/SWAT-T



North American Rescue® C-A-T (Combat Application Tourniquet)

Given the "Top 10 Greatest Inventions" Award by the U.S. Army and tested by the U.S. Army Institute of Surgical Research to be 100% effective in stopping blood flow in both the arms and legs.

- Affordable, lightweight and rugged with easy, one-handed application
- Designed for use in ALL weather conditions
- Enhanced windlass rod 2 times as strong with increased diameter, improved grip
- Highly visible security tab with writeable area to record the time of application
- Red Tip Technology™ with red elliptical tab to assist user in locating and threading during application

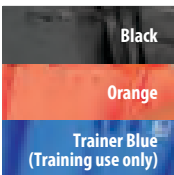

Open: 37½" L. 21 oz

Description	Item	Price
Tourniquet (Black or Orange)	6R1-FA240	\$31.99
Trainer (Blue)	6R1-FA244	\$45.69
Nylon MOLLE/PALS C-A-T Holder	6R1-MB057	\$23.99



Black



Blue



Orange

Tactical Medical Solutions SOF Tactical Tourniquet

Proven to be 100% effective during U.S. Army Institute of Surgical Research testing. Used by the world's elite operators for its dependability, ease of application, and ability to withstand extreme temperatures and operating conditions.

- Aircraft aluminum tourniquet handle withstands extreme temperatures
- Molded Acetyl tri-rings maintain strength in extreme operating conditions
- Designed to reduce the chance of accidental release or mechanical failure
- Fastening system will perform when soiled, muddy, frozen or wet
- Dual locking rings offer a back up locking system

Made in the USA.

Width	Item	Price
SOF Tactical Tourniquet 1"	6R1-FA109	\$45.39
SOF Tactical Tourniquet Wide 1½"	6R1-FA108	\$45.89



Fits 2" belts for convenient carry and instant access



QuikClot® BTK Belt Trauma Kit

This self contained kit provides the immediate hemostatic medical help you need to save a life.

- QuikClot® Combat Gauze LE
- Medical Gloves
- CPR Shield
- SWAT-T pressure tourniquet
- Pouch fits up to a 2" belt and can be worn rotated 90 degrees

6R1-TK149 \$66.99



and Supplies



Dyna Med® Gunshot Trauma Kits

Dyna Med Gunshot Trauma Kits keep you from standing by helplessly while a victim bleeds out. Reach for a kit containing everything you need to stem arterial or venous trauma.

- No hunting for gloves, pads, bandages or other first aid supplies.
- You just can't beat the convenience of having the necessary supplies all in one place, ready for you to use!
- All the supplies you'll need packed in a handy MOLLE pouch

Description	Item	Price
Combat Gauze	6R1-TK099	\$127.89
ACS (not shown)	6R1-TK068	\$111.99



Gunshot Trauma Kit Contents

- | | |
|---|---------------------------------|
| 1 QuikClot® ACS+ Single Dose (3.5 oz) or QuikClot® Combat Gauze(4 oz) | 1 Vaseline Gauze (3" x 9") |
| 1 EMT Shears | 1 Co-Flex (2" x 5 yds) |
| 1 Asherman Chest Seal | 2 ABD Combine Pads (5" x 9") |
| 2 Pair of Nitrile Gloves | 10 Gauze Pads (4" x 4", 12 ply) |
| 1 Blood Stopper | 2 Sani-Dex Hand Wipes |
| | 1 MOLLE Pouch (6"H x 4"W x 1"D) |

VISIT US ONLINE

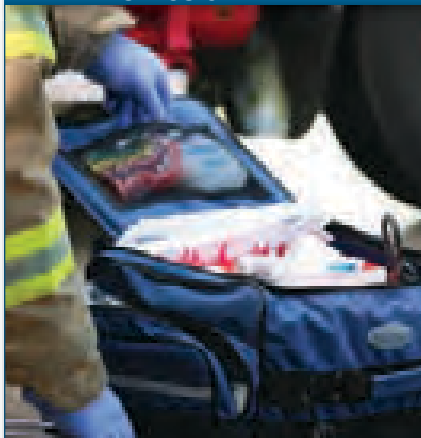

Shop our full selection of tactical trauma kits and supplies online at: galls.com/tactical-trauma-kits



QuikClot® ACS+

Curtails arterial bleeding quickly and easily. This advanced-clotting sponge is designed to adhere effectively to a wound, can be placed at any angle, and can be removed "whole."

- Easy application; simply pack into high-pressure, bleeding wounds
- Sponge design ensures that QuikClot won't blow away in windy environments

Single 100g sponge

6R1-FA213 \$29.99



QuikClot® 1st Response Sponges

QuikClot 1st Response Sponges come in a variety of individually wrapped sponges designed to address various wounds seen by first responders. High visibility packaging makes them easy to locate in trauma or first aid kits.

- Easy to use; just rip open a packet, pack the self-contained sponge into the wound and bleeding stops rapidly
- Sponges will conform to the shape of the wound
- Easily removed in a hospital setting

6R1-FA212 \$39.99/ 5pk

QuikClot® EMS Hemostatic Dressings

The QuikClot EMS family of products help put lifesaving technology in the hands of first responders.

- Soft, white, sterile gauze impregnated with kaolin to promote clotting
- Intuitive, easy-rip package designed for faster opening and removal

Made in the USA

4" x 4" Dressing: 4-ply nonwoven gauze.

6R1-FA014 \$29.99/ 3pk

Rolled Gauze™: 3"H x 48"W nonwoven gauze. 4' length

6R1-FA015 \$19.99

TraumaPad®: 12" x 12" 3-ply pad. Designed to cover large surface areas.

6R1-FA016 \$39.99



QuikClot® Combat Gauze LE™

QuikClot Combat Gauze LE™ controls high volume bleeding and contours to all wounds.

- Individually wrapped in a military grade foil pouch
- Filled with kaolin, an inert mineral that does not contain animal or human proteins or botanicals

3"H x 12"W. z-folded

6R1-FA283 \$42.89

First Aid On-the-Go



Dyna Med 3-in-1 First Aid Kit

Dyna-Med 3-in-1 First Aid Kit includes our Deluxe First Aid Kit to treat minor injuries, a CPR mask kit and a personal protection kit to guard against blood-borne pathogens.

- Meets OSHA and ANSI Z308.1 - 1998 standards
- Red nylon bag dimension: 5"H x 9"W x 5"D. 225 cu in

6R1-FK019 \$74.59

3-in-1 First Aid Kit

CPR Mask Kit contents include:

- 1 Adult CPR Mask
- 1 Vionex Wipe
- 1 Pair of Latex Gloves

Personal Protection Kit contents include:

- 1 Face Mask/Eye Shield
- 1 Antimicrobial Wipe
- 1 Fluid Impervious Gown
- 1 Pair of Latex Gloves
- 1 Biohazard Waste Bag



Dyna Med® Deluxe First Aid Kit

The Deluxe First Aid Kit provides more than 100 basic medical supplies in a pre-packed kit.

- Meets OSHA and ANSI Z308.1 - 1998 standards
- Two holder options: heavy-duty steel case or 197 cu in red nylon bag 200 cu in

\$47.99

Description	Size	Item
Nylon Bag	5"H x 10"W x 4"D	6R1-FK021
Steel Case	10½"H x 7½"W x 2½"D	6R1-FK020

Deluxe First Aid Kit

- | | |
|--|--|
| 1 ABD Combine Pad (5" x 9") | 1 Eye Wash (1 oz) |
| 50 Adhesive Bandages (1" x 3") | 6 First Aid Cream Packets |
| 1 Adhesive Waterproof Tape (½" x 5 yd) | 4 Gauze Pads (3" x 3") |
| 2 Ammonia Inhalants | 1 Gauze Roll (2") |
| 6 Antiseptic Wipes | 5 Nonadhesive Pads (2" x 3") |
| 20 Assorted Woven Bandages | 1 Scissors (4½") |
| 1 Cold Pack (5" x 6") | 1 Triangular Bandage (40" x 40" x 56") |
| 1 Cotton Sterile Roll (0.5 oz) | 1 Tweezers |
| 2 Eye Pads | 1 Pair Latex Gloves |



Adventure Medical® Ultralight Watertight Kits

The ultimate lightweight kits for wet weather adventures. Perfect for boaters, multi-sport athlete and adventure racers. DryFlex™ waterproof bag keeps contents dry.

Description	Item	Size	Weight	Price
.3 Kit	6R1-FA135	5¼"H x 5"W x 1"D	2.32 oz	\$9.00
.5 Kit	6R1-FA134	6½"H x 5"W x 1"D	3.68 oz	\$17.00
.7 Kit	6R1-FA133	6½"H x 8½"W x 1"D	8 oz	\$27.00

Ultralight Watertight .3 Kit

- **Bandage Set:** Adhesive Fabric (1" x 3" 4pk, Knuckle 2pk), Butterfly 2pk, Sterile Gauze (2" x 2") 2pk (3), Moleskin pre-cut & shaped (11 pieces), Tape (½" x 10 yds)
- **Equipment Set:** Safety Pins (2), Splinter Picker/Tick Remover Forceps
- **Medication Set:** Antihistamine diphenhydramine 25 mg (2), Ibuprofen 200 mg 2 pk (2), Antiseptic Wipe (3), Alcohol Swab (2), Single Use Triple Antibiotic Ointment, After Bite Wipe (2)

Ultralight Watertight .5 Kit

- **Bandage Set:** Adhesive Fabric (1" x 3" 5pk, Knuckle 3pk), Butterfly 2pk, Conforming Gauze (2") 2pk, Sterile Gauze (2" x 2") 2pk, 3" x 3" 2pk (2), Non-Adherent Sterile Dressing (3" x 4"), Moleskin pre-cut & shaped (11 pieces), Tape (½" x 10 yds)
- **Equipment Set:** Safety pins (3), Splinter Picker/Tick Remover Forceps
- **Medication Set:** Antihistamine diphenhydramine 25 mg (2), Aspirin 325 mg 2pk (2), Ibuprofen 200 mg 2pk (2), Acetaminophen 500 mg 2pk (2), Antiseptic wipes (6), Alcohol swabs (2), Skin Tac Adhesive Wipes, Single Use Triple Antibiotic Ointment, After Bite Wipe (2)

Ultralight Watertight .7 Kit

- **Bandage Set:** Adhesive Fabric (1" x 3" 5pk, Knuckle 3pk), Butterfly 3pk, Conforming Gauze (2") 2pk (2), Sterile Gauze (2" x 2") 2pk, 3" x 3" 2pk, Dressing, Non-Adherent Sterile Dressing (3" x 4") 2pk, Tape (½" x 10 yds), Moleskin, pre-cut & shaped (11 pieces)
- **Equipment Set:** Nitrile Gloves (pair), hand wipe, Safety pins (3), Splinter Picker/Tick Remover Forceps
- **Medication Set:** Antihistamine Diphenhydramine 25 mg (2), Aspirin 325 mg 2pk (2), Ibuprofen 200 mg 2pk (2), Acetaminophen 500 mg 2pk (2), Antiseptic wipes (6), Alcohol swabs (2), Skin Tac Adhesive Wipes, Single Use Triple Antibiotic Ointment 3pk, After Bite Wipe (2)



DYNAMED

Dyna Med® Trunk First Aid Kit

More than 70 items are included.

- Case has removable tray and locking latch
- Water resistant
- Separate flip-top lid has storage for small items

Black. 10¼"H x 15½"W x 8"D. 1,271 cu in

6R1-TK042 \$74.59

Water-resistant plastic container fits securely in vehicle trunk

Trunk First Aid Kit Contents

- | | |
|--|-------------------------------------|
| 16 Plastic Bandages (1" x 3") | 10 Pkts Triple-Biotic Ointment |
| 1 Abdominal Combine Pad (5" x 9") | 10 Pkts Alcohol Wipes |
| 10 Gauze Pads (4" x 4") | 10 Pkts Sani-Dex Hand Wipes |
| 1 Gauze Clean-Wrap Bandage (4") | 1 Rescue Blanket |
| 1 Gauze Clean-Wrap Bandage (3") | 2 Pair of Latex Gloves (large size) |
| 1 Roll Waterproof Adhesive Tape (½" x 10 yd) | 1 Bottle Eye Wash (4 oz) |
| 1 Roll Waterproof Adhesive Tape (1" x 10 yd) | 1 First Aid Booklet |
| 2 Triangular Bandages | 1 EZ Personal Protection Kit |
| 4 Sterile Oval Eye Pads | 1 Pair of EMS Shears |
| | 1 CPR Mask (adult size) |

DYNAMED

Dyna Med® Rescue Responder Kit

First Aid and biohazard protection. More than 60 essential tools are included. It even contains a Mini-Mag® flashlight! The compact design makes it a great kit for your vehicle. Black nylon bag measures: 9½"H x 18½"W x 9½"D. 1,670 cu in

6R1-TK047 \$90.69



Rescue Responder Kit Contents

- | | |
|------------------------------------|-------------------------------------|
| Rescue Tools | 1 Bloodstopper |
| 1 Shears | 1 Gauze Roll (4") |
| 1 Mini-Mag® Flashlight | 1 Gauze Roll (3") |
| 1 Leather Work Gloves (large size) | 1 Waterproof Tape (1") |
| 1 Galls Zytel Knife | 1 Waterproof Tape (½") |
| 1 Window Punch | 1 Elastic Bandage (3") |
| 1 Seat Belt Cutter | 2 Triangular Bandages |
| Personal Protection Kit | 4 Eye Pads |
| 1 Antimicrobial Wipe | 1 Triple Antibiotic Cream (10/bx) |
| 1 Biohazard Waste Bag | 1 Alcohol Wipes (10/bx) |
| 1 Face Mask/Eye Shield | 10 Antimicrobial Towelettes |
| 1 Fluid Impervious Gown | 1 Space Blanket |
| 1 Pair Latex Gloves | 1 Pair of Latex Gloves (large size) |
| Bandages and Supplies | 1 Eye Wash (4 oz) |
| 16 Adhesive Bandages | 1 First Aid Booklet |
| 1 Abdominal Pad (5" x 9") | 1 Duffel Bag (19" x 9½") |
| 10 Gauze Pads (4" x 4") | 1 CPR Mask |

Safetec

Safetec Personal Protection Kit

Completely disposable, this Personal Protection Kit is a must for first responders at a scene where body fluids are present. Meets OSHA and CDC standards for bloodborne pathogens.

6R1-HM227 \$9.49

Personal Protection Kit Contents

- | | |
|-------------------------------------|-------------------------|
| 1 Powdered Exam Gloves | 1 Procedure™ Mask |
| 1 Sani-Dex Antimicrobial Towelettes | 1 Fluid Impervious Gown |
| 1 Fluidshield® | 1 Biohazard Waste Bag |



Safetec Universal Protection Kit

Completely disposable, this Universal Protection Kit is designed for your personal protection, plus supplies for area clean up. Meets OSHA and CDC standards for bloodborne pathogens.

6R1-HM228 \$16.79

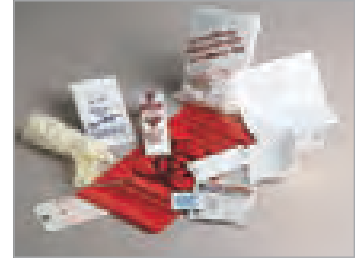

Universal Protection Kit Contents

- | | |
|----------------------|-----------------------|
| 1 Red Z™ Solidifier | 1 Face Mask/Eyeshield |
| 1 Medical Gloves | 1 Protective Apron |
| 1 Scoop and Scraper | 1 Identification Tag |
| 1 Antimicrobial Wipe | 1 Biohazard Waste Bag |
| 1 Germicidal Wipe | 1 Instruction |

DYNAMED

Dyna Med® Obstetrical Kit

The highest quality O.B. kit in the market and competitively priced! Includes all the necessary tools and high quality supplies for successful delivery of a neonate.

- Durable, reusable plastic case
- Case features slide lock closures with inventory tag holes

12"L x 12"W x 2"D. 2 lbs

6R1-FK008 \$22.99

Kit Refill **6R1-FA050 \$21.79**



Durable plastic case

Obstetrical Kit Contents

- | | |
|---------------------------------------|----------------------------|
| 1 Aspirator Bulb | 3 PDI PVP Medium Prep Pads |
| 1 Clear Poly Zip Bag | 1 TIDI Drape Sheet |
| 1 Dynarex Disposable #10 Scalpel | 1 TIDI Towels |
| 1 Kendall Curity Disposable Under Pad | 2 Twist Ties |
| 1 Kendall Curity Maternity Pad | 6 Sterile Sponges |
| 1 Pair Sterile Latex Surgical Gloves | 2 Umbilical Cord Clamps |
| 3 PDI Cleansing Towelettes | |

Adventure-Ready



1.0 First Aid Kit
Over 45 Pieces



2.0 First Aid Kit
Over 90 Pieces



80 Pieces

Adventure Medical® First Aid Kits

Easy Care™ First Aid System organizes items by injury, with injury-specific instruction cards to help anyone quickly and confidently give first aid. Organized into injury-specific pockets for fast first aid. Coated nylon outer bag with waterproof plastic inner bags.

1.0: Supplies for 1-2 people. 6½"H x 5"W x 1"D. 8 oz

6R1-FK027 \$10.99

2.0: Supplies for 1-4 people. 8½"H x 6"W x 1½"D. 16 oz

6R1-FA131 \$23.00



Weather-Resistant Nylon Outer Bag

Adventure Medical® Family First Aid Kit

Essential first aid supplies for adults as well as instructions and supplies specifically designed for children. Includes critical information on wound care, stabilizing sprains and fractures, and medications for children. Coated nylon outer bag with waterproof plastic inner bags.

6"H x 8½"W x 3"D. 17 oz

6R1-FA143 \$30.00

First Aid 1.0 Kit

- Bandage Set:** Adhesive Fabric (1" x 3" 12pk, 2" x 4½", Knuckle 2pk, Butterfly 3pk, Sterile Gauze (2" x 2" 2pk, 3" x 3" 2pk), Moleskin (3" x 4"), Elastic with clips (2"), Tape (½" x 10 yds), Antiseptic Wipes 10pk
- Splinter Picker/Tick Remover Forceps**
- Medication Set:** (Acetaminophen 500 mg 2pk, After Bite Wipe 2pk, Antihistamine Diphenhydramine 25 mg 2pk, Ibuprofen 200 mg 2pk, Aspirin 325 mg 2pk, single-use triple antibiotic ointment
- Button Compass, Rescue Whistle Set**

First Aid 2.0 Kit

- Bandage Set:** Adhesive Fabric (1" x 3" 16pk, 2" x 4½", Knuckle 4pk), Plastic (¾" x 1½") 12pk, Butterfly 4pk, Sterile Gauze (2" x 2" 2pk (4), 3" x 3" 2pk (4), 4" x 4" 2pk), Non-Adherent Steril Gauze (2" x 3") 2pk (4), Trauma Pad (5" x 9"), Moleskin, pre-cut & shaped (11 pieces), Elastic
- Bandage with clips (2"), Tape (½" x 10 yds), Antiseptic Wipes 12pk
- Equipment Set:** Nitrile Gloves (pair), Hand Wipe, Cold Pack, Safety Pins (2), Blunt Tip Bandage Scissors, Splinter Picker/Tick Remover Forceps, Disposable Thermometer (2), Caring for Children in the Outdoors manual,
- Cotton tip applicator 2pk (2)
- Medication Set:** Acetaminophen 500 mg 2pk (3), Antihistamine Diphenhydramine 25 mg (3), Ibuprofen 200 mg 2pk (3), Aspirin 325 mg 2pk, After Bite® insect relief, Single-Use Triple Antibiotic Ointment 4pk

Family First Aid Kit

- Bandage Set:** Adhesive Fabric (1" x 3" 16pk, 2" x 4½", Knuckle 4pk), Butterfly 4pk, Dressing, Gauze, Sterile, (2" x 2" 2pk, 3" x 3" 2pk (2), 4" x 4" 2pk(2)), Non-Adherent Sterile Dressing (2" x 3") 2pk, Trauma Pad (5" x 9"), Moleskin (3" x 4"), Elastic Bandage with clips (2"), Tape (½" x 10 yds), Antiseptic Wipes 12pk
- Equipment Set:** Nitrile Gloves (pair), Hand Wipe, Cold Pack, Safety pins (2), Bandage Scissors with Blunt Tip, Splinter Picker/Tick Remover Forceps, Disposable Thermometer (2), Cotton Tip Applicator 2pk (4)
- Medication Set:** Acetaminophen 500 mg 2pk (3), Antihistamine Diphenhydramine 25 mg 3pk, Ibuprofen 200 mg 2pk (3), Single Use Triple Antibiotic Ointment (4), After Bite® Kids (Tube), Natrapel® 8 Hour Tick and Insect Repellent Wipes, After Bite Wipe (2)
- Button Compass, Rescue Whistle Set**

Adventure Medical® Pre-Cut Moleskin

Apply moleskin before you hike or bike to stop blisters before they form. Easy-to-apply die-cut shape fits common problem areas, including the heel, side of foot, and toes.

- Reduces friction to prevent blisters from forming
- 22 pre-cut pieces (11 per sheet)
- Includes 6 alcohol wipes for surface prep
- Includes foot care instructions

6½"H x 4¼"W x ½"D. 1.6 oz (packaging)

6R1-FA167 \$6.00



Adventure Medical® Kits

BE SAFE

Adventure Medical® GlacierGel Blister and Burn Dressing

Instant pain relief for blisters and burns. Waterproof, breathable adhesive Glacier Gel™ dressings are highly cushioning, cooling and absorbent. Easy to apply and stays in place for multiple days.

- Stops pain and starts the healing process on contact
- Keeps the blister area clean and protected while allowing moisture to escape the dressing
- No tape needed

6½"H x 4¼"W x ½"D. 1.6 oz (packaging)

6R1-FA156 \$10.00



Adventure Medical® Blister Medic Kit

Combines the advanced relief and healing of Glacier Gel™ hydrogel dressings with the proven preventative protection of Moleskin.

- Moleskin prevents blisters from forming
- 11 die-cut moleskin pieces per sheet, shaped to fit common blister areas
- Glacier Gel™ blister dressings stop pain and start the healing process on contact
- Antiseptic wipes disinfect open blisters to prevent infections

6½"H x 4¼"W x ½"D. 1.9 oz (packaging)

6R1-FA157 \$10.00



First Aid Kits and Supplies



**Adventure
Medical
Kits**

BE SAFE



Weather-Resistant
Nylon Outer Bag

Adventure Medical® Mountain Series Day Tripper Kit

Professional-quality first aid supplies in a compact kit. Supplies for 1-5 people.

7½" H x 5¼" W x 3" D. 15 oz.

6R1-FA127 \$33.00

Mountain Series Day Tripper Kit

- **Bandage Set:** Adhesive Fabric (1" x 3" 5pk, Knuckle 3pk), Butterfly 4pk, Sterile Gauze (2" x 2" 2pk (2), 4" x 4" 2pk (2)), Non-Adherent Sterile Dressing (2" x 3") 2pk, Tape (1" x 10 yds), Trauma pad (5" x 9"), Elastic Bandage with VELCRO® brand closure (2"), Moleskin pre-cut & shaped (14 pieces)
- **Equipment Set:** Nitrile Gloves (pair), Hand Wipe, Safety pins (2), Splinter Picker/Tick Remover Forceps, Guide to Wilderness & Travel Medicine
- **Medication Set:** Antihistamine Diphenhydramine 25 mg (2), Aspirin 325 mg 2pk (2), Diamode Ioperamide HCl 2 mg 1pk (2), Ibuprofen 200 mg 2pk (3), Cotton Tip Applicator 2pk, Irrigation Syringe 20 cc 18 Gauge Tip, Antiseptic Wipes (4), Alcohol Swabs (2), Skin Tac Adhesive Wipes, Single Use Triple Antibiotic Ointment (3), After Bite Wipe (2)



Adventure Medical® Mountain Series Weekender Kit

Affordable, portable and capable of handling most backcountry emergencies. Easy Care™ organization. Supplies for 1-6 people.

6R1-FA128 \$60.00

Weather-Resistant
Nylon Outer Bag

Mountain Series Weekender Kit

- **Bandage Set:** Adhesive Fabric (1" x 3" 5pk, Knuckle 5pk), Conforming Gauze (3") 2pk, Sterile Gauze (2" x 2" 2pk (2), 4" x 4" 2pk (2)), Non-Adherent Sterile Dressing (3" x 4") 2pk, Elastic Bandage with VELCRO® brand (3"), Triangular Bandage, Tape (1" x 10 yds), Wound Closure Strips (¼" x 4") 10pk, Trauma Pad (5" x 9"), Moleskin pre-cut & shaped (14 pieces)
- **Equipment Set:** Nitrile Gloves (pair), Hand Wipe, CPR face shield, Duct Tape (2" x 5 yds), Instructions Easy Care™ fracture & sprain, EMT Shears (4"), Pencil, Safety pins (3), Splinter Picker/Tick Remover
- **Medication Set:** Acetaminophen 500 mg 2pk (2), Antihistamine diphenhydramine 25 mg (2), Aspirin 325 mg 2pk, Ibuprofen 200 mg 2pk (2), Antiseptic Wipes (6), Cotton tip applicator 2pk (2), Povidone iodine (3/4 oz), Irrigation Syringe 20 cc 18 gauge tip, Skin Tac Adhesive Wipes (2), GlacierGel (Large Oval)

Forceps, Disposable Thermometer (3), Guide to Wilderness & Travel Medicine, Patient assessment form, Instructions Easy Care™ medications, Instructions Easy Care™ wound, Instructions Easy Care™ bleeding



DYNAMED

Dyna Med® Emergency Blanket

This aluminum polymer emergency blanket can be taken anywhere, anytime.

- Retains body heat for shock victims while blocking cold, wind and moisture
- Can also be used as an emergency stretcher and will support more than 250 pounds if not punctured

54" x 84". 2 oz

6R1-EB712 \$7.59

**Adventure
Medical
Kits**

BE SAFE

Adventure Medical® Survive Outdoors Longer Survival Blanket

The most advanced emergency blanket on the market, meticulously designed never to fail when your life counts on it.

- Vacuum-metallized polyethylene
- Survival instructions printed directly on the blanket for easy reference when you need it most
- Resists tearing and will not shred like Mylar blankets
- Heatsheets® material is waterproof and windproof
- Can also be used as a ground cloth
- Reflects 90% of radiated body heat

60" X 96". 3.2 oz

6R1-EB015 \$7.00



Available in two sizes: 1-person and 2-person

60" x 84"

Adventure Medical® Survive Outdoors Longer Emergency Bivvy

The same ultra-light, ultra-warm, emergency shelter that professionals rely on. Full-protection emergency shelter for warmth in extreme temperatures.

- Seam-taped and fully sealed for protection from rain, wind and snow
- Heatsheets® material is waterproof and windproof
- Reflects 90% of radiated body heat

Size	Item	Price
60" x 84"	6R1-EB010	\$23.00
36" x 84"	6R1-EB009	\$17.00

Reliable Diagnostic Equipment



Available in 5 sizes



Single Cuff

ADC Blood Pressure Kits

ADC BP kits with multi-cuff size options.

- Ambidextrous, palm-style, trigger-operated manometer
- Integral latex-free bulb and a precision crafted 300 mmHg no-pin stop German mechanism
- VELCRO® brand cuffs with index line markings for proper cuff positioning
- Compact, multi-pocketed nylon case

Colors: Black (DD001), Navy (DD967, DD968, D969), Orange (DD967, DD968, DD969)



Tri Cuff Navy

Orange

Description	Item	Infant	Child	Adult	Large Adult	Thigh	Price
Single Cuff	6R1-DD001		x	x	x		\$93.99
Tri Cuff	6R1-DD967		x	x	x		\$131.99
Quad Cuff	6R1-DD968	x	x	x	x		\$137.99
Quint Cuff	6R1-DD969	x	x	x	x	x	\$162.39



ADC BP/Stethoscope Kit

This ADC Kit couples a pocket aneroid sphygmomanometer with a dual-head stethoscope.

- Combination diaphragm/bell chest piece for wide frequency response
- Black enamel 300 mmHg no-pin stop manometer for BP unit
- Extra pair of black ear tips
- Black leatherette zippered carrying case included

6R1-DD009 \$26.39



Navy



ADC Color-Coordinated Stethoscope/BP Unit

Kit: includes a color-coordinated blood pressure unit, Sprague stethoscope and nylon bag.

- Contemporary white-faced, 300 mmHg no-pin stop manometer with black numerals
- Nickel-plated deflation valve and nylon cuff with size guide
- Warranties – 20-year on calibration and two-year on inflation system

Sprague Stethoscope:

- Threaded chest piece drum permits five interchangeable chest piece fittings
- Chrome-plated brass binaurals and 22" tubing
- Nylon bag: 5"H x 9½"W x 2½"D

6R1-DD007 \$40.59

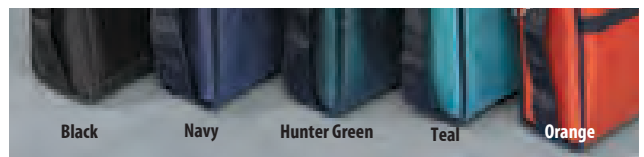

Black

Navy

Hunter Green

Teal

Orange

From the Most Trusted Brands

\$13⁹⁹



Dynarex Adult BP Cuff

Ideal for the cost-conscious healthcare provider looking for quality and affordability.

- State-of-the-art aneroid sphygmomanometer provides accurate blood pressure readings
- Chrome-plated, precision crafted parts
- Easy to read 300 mmHg with air release valve

6R1-DD132 \$13.99

\$6⁹⁹



Dynarex Single Head Stethoscope

A very cost-effective stethoscope that doesn't sacrifice quality.

- Sleek, durable, lightweight construction
- High quality, non-chill anodized chest piece
- 22" latex-free PVC flexible tubing

6R1-DD133 \$6.99



ADC Sprague-Rappaport Stethoscope

Convertible design with consistent acoustics.

- Adsoft™ ear tips
- 1 pair mushroom and 1 pair silicon ear tips
- Extra adult-size diaphragm with 3 pediatric bells
- ID tag

Colors: Black, Teal, Navy, Hunter Green, Neon Orange. Overall length: 29". 6 oz

6R1-EM264 \$16.99



ADC Stainless Steel Stethoscope

Stethoscope designed for a clear transmission of a wide frequency range.

- Stainless steel
- Surgical stainless steel chest piece
- Stainless binaural
- Adsoft™ ear tips (an extra pair included)
- Extra diaphragm
- ID tag

Colors: Black, Teal, Royal Blue. Overall length: 28". 6.5 oz

6R1-EM265 \$43.49

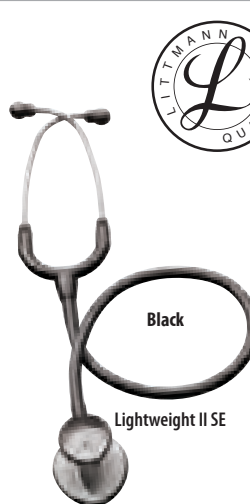
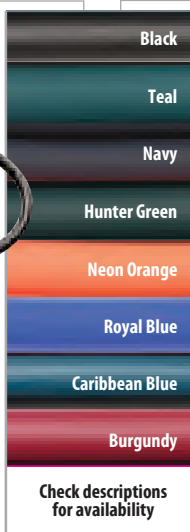

Littmann Lightweight II SE

Stethoscope with a two-sided chest piece made of high-tech resin.

- Single lumen binaural
- Multi-frequency
- Soft-sealing ear tips

Colors: Black, Caribbean Blue, Burgundy. Overall length: 28". 4 oz

6R1-DD127 \$49.99

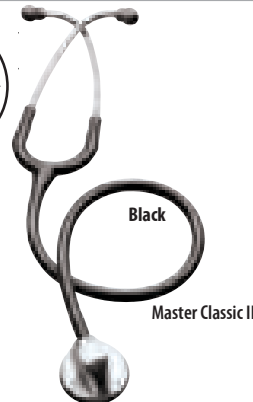

Littmann Master Classic II Stethoscope

This stethoscope provides incredible acoustical response.

- Plated alloy, single-sided chest piece
- Thick, single-lumen binaural
- Multi-frequency
- Soft-sealing ear tips

Colors: Black, Navy, Burgundy. Overall length: 27". 5 oz

6R1-DD128 \$132.99

PHILIPS

PHILIPS HeartStart® OnSite Defibrillator

Designed to provide superior performance by anyone with little medical training, while remaining budget friendly.

- Meets AAMI DF80 guidelines and AHA recommendations for adult defibrillation
- Equipped with SMART Heart Rhythm Analysis and SMART Biphasic Technology
- Can be used on victims of any age, including infants and children
- Unit conducts self-check tests daily to ensure readiness
- Detailed voice prompts and visual icons guide responder through use of the defibrillator

3.25 lbs with battery and pad cases. 8³/₁₆"H x 7⁷/₁₆"W x 2⁵/₁₆"D. Unit comes with 1 battery and 1 set of adult SMART pad cartridges. Please allow 7 days for factory delivery

6R1-DD084 \$1385.49



PHILIPS HeartStart® FRx™ AED

Constructed to be the easiest to own AED on the market, the HeartStart® FRx™ AED's lightweight and rugged design is perfect for first responders.

- Meets AAMI DF80 guidelines and AHA recommendations for adult defibrillation
- Uses SMART Biphasic Technology to assess the victim's heart rhythm and determines the level of shock needed
- Unit conducts self-check tests daily to ensure readiness
- Rugged design can withstand jetting water, a one meter drop on concrete, and loads up to 500 lbs
- Detailed voice prompts and visual icons guide responder through use of the defibrillator

3.5 lbs with battery and pad cases. 7¹/₈"H x 8⁷/₁₆"W x 2³/₁₆"D. Carry case is not included. Please allow 7 days for factory delivery

6R1-DD143 \$2099.00



Prepare for Rescue and First Response



Dynarex Finger Pulse Oximeter

This non-invasive finger pulse oximeter offers a lightweight design that promises to be easy on your budget. Accurately calculate oxygen in a patient's blood and monitor saturation of hemoglobin with the press of a button. The oximeter is also a convenient method to detect hypoxia.

- Light and compact design
- Clinically tested for accuracy
- Simple one button operation
- Withstood drop testing for durability
- Moisture proof
- Perfect for spot checks or continuous readings
- Designed for pediatric and adult patients
- Requires (2) AAA batteries (sold separately)

2¼"W x 1⅞"H x 1⅞"D

6R1-DD006 \$60.89

AAA Batteries **6R1-FH206 \$4.99/2 pk**



ADC Diagnostix Pulse Oximeter

Fingertip Pulse Oximeter is a simple non-invasive digital device that indirectly measures the oxygen saturation of a patient's blood (SPO₂).

- Reads SPO₂ and Pulse Rate
- 6 changeable display modes
- Visual and audible alarms
- Comes with carry lanyard
- Black rubberized bumper

1⅞"H x 1⅞"W x 2⅞"D. 2 AAA Batteries included

6R1-DD129 \$121.79

AAA Batteries **6R1-FH206 \$4.99/2 pk**



SIMULAIDS, INC.

Simulaids Rescue Randy

Developed for lifelike adult or juvenile patient handling, transportation, and extrication training. Ideal for scenarios that are too hazardous to use human volunteers. Used by emergency personnel for rescue and extrication protocols worldwide.

- Durable vinyl construction with 4,100-lb. test plastic-coated cables
- Articulated joints for realistic flexibility
- Additional reinforcements for dragging
- Weight distribution according to human weight distribution chart
- Randy can sit, lie or flex into any position needed for a training scenario
- Latex-free

Available in 3 sizes and weights. Clothing not included

Description	Item	Price
105lbs, 5'5" tall	6R1-TA1313	\$912.99
145lbs, 6'1" tall	6R1-TA760	\$1080.99

165lbs, 6'1" tall: I.A.F.F. certified. Additional reinforcements for extreme durability. Official manikin of the Firefighter Combat Challenge

6R1-TA1325 \$1321.99



Perfect for rescue and extrication training



CPR Prompt™ Training Pack

These packs are ideal for CPR classes. The sturdy carry case protects and organizes the equipment for the instructor on the go.

- Designed to meet American Heart Association criteria for desirable manikin features
- Built-in feedback features, tilting head and visible chest rise help identify when key skills are performed correctly
- Heads are dishwasher safe, may be soaked in bleach solution or wiped with other sanitizing agents

Includes: 5 Adult/Child Manikins and 50 Adult/Child Lung Bags

6R1-TA718 \$505.49



CPR Prompt manikins allow trainees to safely practice CPR and the Heimlich Maneuver



A
Black



B



Available colors

Magnum Medical Pro-Series Shears

Greater comfort and more cutting power than previous models. Also available with carabiner clip handle for easy attachment to your favorite first aid kit! Thirty percent larger handles and 20% stronger rivets than previous models.

Sizes: 5½" or 7½"L. Handle colors: Fire Engine Red, Coral Green, Yellow, Orange, Black and Royal Blue

Description	Item	Price
A) 5½"L	6R1-IN743	\$4.99
7½"L	6R1-IN700	\$6.99
B) 7½"L (with carabiner handle)	6R1-FA277	\$8.99



Magnum Medical Colored Instrument Holster Kit

Med tools that are the same color help you stay organized while working with multiple responders at the scene.

- Fits belts up to 2¼"W
- Holster measures 7½"H x 3½"W x ½"D

6R1-EM227 \$24.99



Colored Instrument Holster Kit Contents

1 7½" Deluxe EMS Shears	1 5½" Kelly Forceps
1 5½" Bandage Scissors	1 Cordura™ Nylon 2-Pocket Holster
1 Pupil Gauge Penlight	

Deliver Lifesaving CPR without Worry



Dyna Med® Microkeys

CPR protection always available on the go. Be available to save a life and keep yourself protected with Dyna Med Microkey system.

- Clear, flexible Microshield® barrier
- Positive one-way valve in the breathing tube
- Keychain carrying case

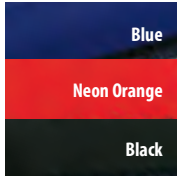

Buy More Save More

Description	Item	Price
Without Gloves	6R1-RO831	\$11.79/ea
Without Gloves	6R1-RO059	\$96.39/10 pk
With Gloves	6R1-RO832	\$12.79/ea
With Gloves	6R1-RO060	\$101.29/10 pk

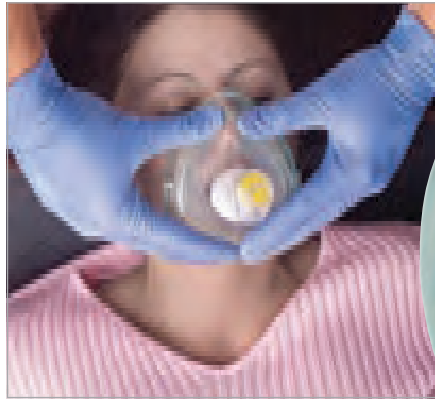

Without O2 Inlet



With O2 Inlet

Dyna Med® CPR Masks

Greater than 99% viral and bacteria filter efficiency.

- Pre-inflated cuff for an effective seal
- Distance to patient allows user to check mouth color, secretions and chest movement
- Both come with a 3M™ Filtrate™ hydrophobic filter to prevent the passage of liquids. R0024 comes equipped with O2 inlet to facilitate delivery of supplemental oxygen (head strap included)

Description	Item	Price
Mask without O2 Inlet	6R1-RO007	\$9.69
Mask with O2 Inlet	6R1-RO024	\$10.89

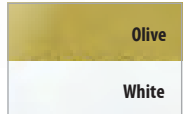

Natural rubber bag always returns to normal shape



Allied Healthcare Products, Inc.

Allied Healthcare Disposable BVM with Handle

Sure-grip handle allows you to resuscitate a patient using one hand.

- Adult bag provides 1488 ml volume (625 ml average stroke volume one-handed)
- Rapid refill time so the proper amount of RPM will be attained
- Built-in safety valve allows entrainment of room air
- Manometer port with cap
- Adjustable exhalation deflector port with a 30 mm PEEP connector and a swivel patient connector
- Reservoir and mask are included

\$19.29

Adult	6R1-RB001
Pediatric	6R1-RB003
Infant	6R1-RB004



Life Mask Compact Barrier Kit

Combines the reliability of a one-way valve with the added protection of a 3M™ Filtrate™ filter. Kit contents listed below.

6R1-EM180 \$19.99

Barrier Kit Contents

- 1 Pair of Gloves
- 1 Vionex® Antimicrobial Towelette
- 1 Nylon Twill Black Holster fits belts up to 2½" W
- 1 CPR Mask

Your Solutions Provider

We have the resources and expertise to be your primary supplier for uniforms and equipment that you need to safely do your job.

As the industry leader for public safety uniforms and equipment, we offer what you would expect from over 45 years experience.



Dyna Med® CPR Holster Kit

Front pouch on holster holds gloves and wipes.

- "Fast attach" belt loop for easy on/off
- CPR Mask available with or without O2 inlet (see R0024 above for details)
- Black holster also sold individually

Description	Item	Price
Without O2 inlet	6R1-RK040	\$18.19
With O2 inlet	6R1-RK041	\$20.29
Holster Only	6R1-NP380	\$13.89

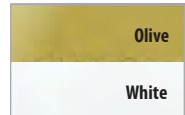

Holster Kit Contents

- 1 CPR Mask with hard case
- 1 Pair of Nitrile Gloves (large size)
- 1 Packet of Antimicrobial Wipes
- 1 Holster (6" H x 5" W x 2"D) fits belts 2½" W

Immobilization and Extrication Equipment for any Situation



Dyna Med® Multi-Purpose Boards

Depend on Dyna Med spine boards in a variety of emergency situations.

- Rugged High Density Polyethylene (HDPE) plastic construction virtually unbreakable and doesn't chip
- X-ray translucent and ideally suited for CPR and extrication
- Convex underside has runners that make handles easy to grasp
- Compatible with most head immobilizers

72"L x 18"W x 2½"D. 17 lb. 500 lb capacity

6R1-SB026 \$118.99

With 3 Standard Straps: Comes with three two-piece radio-transparent restraint straps and plastic buckles.

6R1-SB031 \$144.49

With Spider® Straps: Comes with the Spider® Straps, an innovative system with 10 points of attachment.

6R1-SB032 \$204.89

Disposable Speed Clip Strap **6R1-RS230 \$14.49/3 pk**

Disposable Standard Strap **6R1-RS234 \$16.59/3 pk**

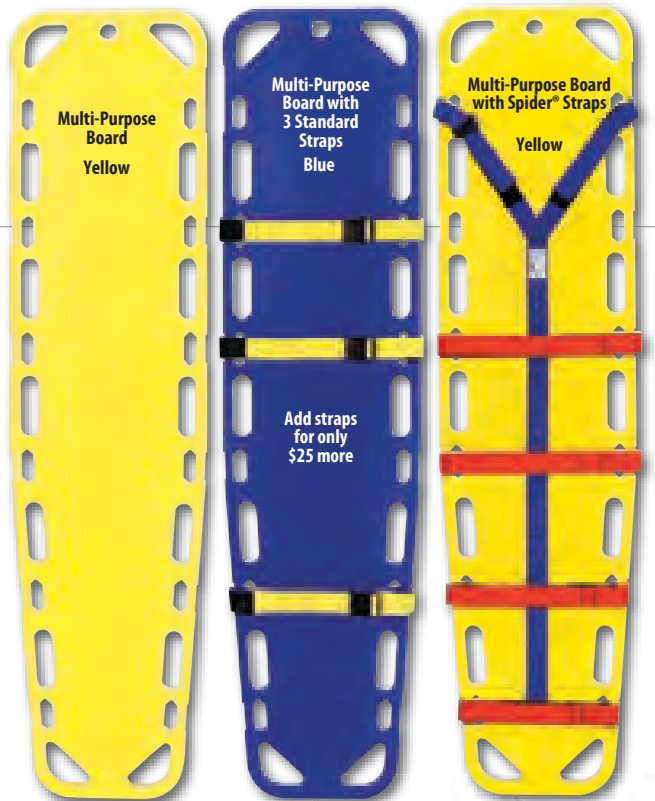

FERNO EZ Glide™ Evacuation Stair Chair

Evacuate individuals quickly, safely, and easily from multiple level buildings with Ferno's EZ Glide™ Evacuation Chair. The EZ Glide™ Track System carries the weight down stairs, allowing one person to evacuate individuals up to 200 lbs, and two people to evacuate individuals up to 500 lbs.

- Metal frame construction for strength and long service life
- 5 position lift bar and handles offers maximum control to operators of various heights
- Front swivel wheels and 1" track to ground clearance provides superior maneuverability
- Folding design and multiple storage options allows for versatile storage in any location

20"W x 37½"H; rear lift bar 37½"-63½"H; front lift bar 5½"-19"H. Load limit: 500 lb; chair weight: 33 lb

6R1-PT370 \$3,082.00



FERNO K.E.D.® Kendrick Extrication Device



The Original Ferno K.E.D.® is ideal for extricating and immobilizing patients from auto accidents and other confined spaces. X-rays or advanced life support procedures can be performed with the K.E.D.® in place.

- Heavy-duty, vinyl-coated nylon
- Wraparound design provides horizontal flexibility for easy application and vertical rigidity for maximum support of the spine, neck, and head during extrication
- Built-in handles give rescuers a firm grip on the patient and K.E.D.®
- Adapts to a hip and pelvic splint by simple inversion
- Adjustable, fold-back sides permit easy access to patient's chest
- Includes wrap-around vest, Adjusta-Pad neck roll, 2 head straps and a carrying case

33"L x 32"W (Open); load limit: 500 lb; restraint weight: 8lb

6R1-IE029 \$124.00

SAM Splints

Structural Aluminum Malleable or the SAM Splint comes in three sizes and styles.

- Apply to a variety of fracture locations
- Easily trimmed to form finger splints
- .02 strips of soft aluminum with a polyvinyl coating (no impediment to x-rays)
- Unaffected by extreme temperatures
- Waterproof

Colors: Orange, Gray

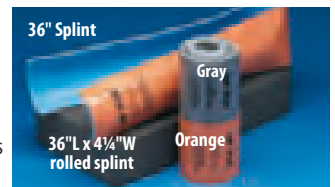

Description	Item	Price
18"L Flat	6R1-SI731	\$9.49
36"L Rolled	6R1-SI729	\$12.99
36"L Flat	6R1-SI730	\$12.79

Questions?

Our knowledgeable and helpful customer service representatives are available Monday-Friday 8:00 a.m. - 9:00 p.m. ET. Call 800.477.7766 to place an order, ask a question or learn more about our products.

Dyna Med® Hare Traction Splint

The Hare Traction Splint from Dyna Med effectively realigns a fractured femur to its proper position, which can reduce pain and restore perfusion to an injured leg. It also inhibits further hemorrhage and additional nerve, vascular, bone or muscle damage. The one-piece design makes application fast, easy and complete in minutes.

- Larger traction knob for better grip and control; ratchet traction device and "S" ring hook
- One-handed traction adjustment; recessed traction release button
- Positive locking heel stand
- Faster length adjustment; collets lock with a few quick turns
- 4 leg support straps; Dyna Med adjustable ankle strap; Ischial strap and pad
- Nylon carrying case

Sizes: adult or pediatric (well-labeled)

6R1-SI008 \$272.99

Replacement Ankle Straps **6R1-SI006 \$17.49**
 Replacement Leg Straps **6R1-SI007 \$34.29**



Recessed, Traction Release Button

\$272⁹⁹



Laerdal
helping save lives

Laerdal Stifneck Select™ Collar

The Stifneck Select™ Collar is adjustable, providing four different adult sizes, reducing inventory costs and saving space.

- Locks ensure selected sizes stay in place
- Adjustment tracks ensure symmetrical alignment of size
- Large tracheal opening to permit easy access for pulse checks and advanced airway procedures
- Rear panel opening allows C-spine palpation
- Stores flat
- Radiolucent, MRI and CT scan compatible

Adjustable sizes: tall, regular, short and No-Neck™

6R1-IE747 \$14.19



Ambu =

Ambu Perfit ACE Adjustable Extrication Collar

The Ambu Perfit ACE Adjustable Extrication Collar is the only one-piece rigid cervical spine immobilization device that provides 16 precise settings for a customized fit.

- 16 adjustable settings
- Ventilated, posterior shell for fluid drainage
- Stores completely flat
- Color-coded numbering and sizing
- X-ray, CT and MRI compatible

Adjustable sizes: neckless to tall (*adult sizes only*)

6R1-IE744 \$18.19

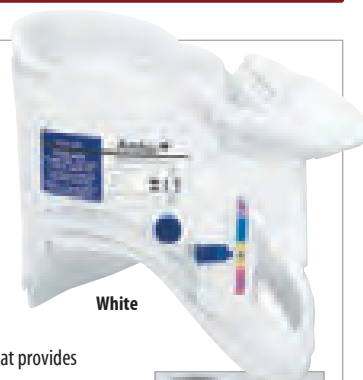

White



Olive Drab



Dyna Med® Head Immobilizers

Controls head movement and maintains proper cervical spine alignment. Maximum patient comfort during transport.

- Fast, easy to use VELCRO® brand fastening system
- Monitor hemorrhage or drainage via ear holes
- Non-absorbant, closed-cell foam
- Universal attachment base with built-in occipital pad, 2 head blocks, head straps (pair) included

Head Immobilization System comes in Yellow or Orange. Replacement parts available below.

6R1-IE015 \$110.29

Replacement Head Straps **6R1-IE719 \$24.59**
 Replacement Head Blocks **6R1-IE720 \$61.99**
 Replacement Base **6R1-IE721 \$68.69**

HeadFirst Immobilizer features recessed sides to ensure head straps will not slide off head blocks. Available in Lime Yellow or Fluorescent Orange

6R1-IE016 \$117.29

Replacement Head Straps **6R1-IE734 \$24.99**
 Replacement Head Blocks **6R1-IE733 \$61.99**
 Replacement Base **6R1-IE732 \$72.79**

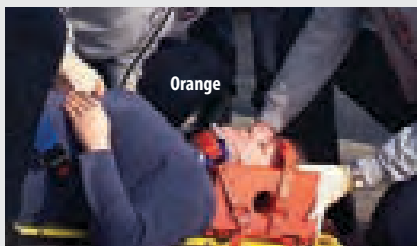

Orange

Head Immobilization System Yellow



HeadFirst Immobilizer Lime Yellow



Protect Yourself with Traditional Latex Gloves



Dyna Med® Latex Exam Gloves

Get a better grip with Dyna Med's Basic Glove!

- Class 1 Medical Device
- Beaded cuff for easy on and off
- Available in powdered and powder-free

Sizes: S-XL. Ambidextrous. 100 gloves per box. 6½ mil thick. 9"L

Description	Item	Price (100/pk)
Powdered	6R1-GL155	\$16.99
Powder-Free	6R1-GL156	\$19.19



Dyna Med® Protection-Plus Latex Gloves

Dyna Med offers these extra-thick latex gloves when added protection is needed.

- Class 1 Medical Device
- Textured for better gripping
- Beaded cuff for easy on and off

Sizes: S-XL. Ambidextrous. 14 mil thick. 12"L. 50 gloves per box

Description	Item	Price (50/pk)
Powdered	6R1-GL157	\$25.99
Powder-Free	6R1-GL158	\$25.59



MICROFLEX® THE MOST TRUSTED NAME IN GLOVES®

Microflex® Latex Gloves

Microflex Latex Gloves provide durability and strength when you need it most. Constructed of comfortable latex these gloves provide barrier protection against hazards.

- Class 1 Medical Device
- Beaded cuffs allow for easy on and off

Sizes: S-XL. Ambidextrous



Glove Description	NFPA Rated	Mil Thickness	Finger Length	Powder	Number of Gloves	Item	Price/box
A) Micro One™	–	6	9"	Low Powder	100	6R1-GL702	\$14.99
B) Diamond Grip™	–	9	9"	Powder-Free	100	6R1-GL703	\$19.99
C) Synetron®	Yes	12	11"	Powder-Free	50	6R1-GL742	\$21.89
D) Ultra One®	Yes	14	12"	Powder-Free	50	6R1-GL700	\$22.89
E) SafeGrip™	Yes	17	12"	Powder-Free	50	6R1-GL701	\$20.29



Dyna Med® Glove Carriers

Sturdy black 900 denier polyester carriers keep gloves accessible at all times.

- Hook and loop closure
- "Fast attach" belt loop
- Fits belts up to 2"W

Description	Capacity	Item	Price
A) Single Glove Pouch	1 pair	6R1-NP376	\$7.59
B) Double Glove Pouch	2 pairs	6R1-NP377	\$8.59
C) Extra Large Pouch	4 pairs	6R1-NP378	\$9.69
D) Twin Pocket Foldout Pouch	4 pairs	6R1-NP379	\$10.69



Prevent Allergic Reactions with Nitrile Gloves

\$20⁹⁹

DYNAMED

Dyna Med® Black Nitrile Gloves

Keep a low profile with these gloves when rendering medical care in hot zones.

- Class 1 Medical Device
- Beaded cuff for easy on/off
- Eliminates allergic reactions to latex
- Powder-free for no irritation when worn over an extended period of time

Sizes: S-XL. 100 gloves per box. 5 mil thick (at palm). 7 mil thick (at fingertips)

6R1-GL259 \$20.99



Black nitrile gloves provide a low profile

DYNAMED

Dyna Med® Nitrile Gloves

Nitrile offers softness, sensitivity, flexibility and an exceptional snug fit.

- Class 1 Medical Device
- Eliminates allergic reactions to latex
- Textured fingertips
- Beaded cuff for easy on and off

Powered sizes: S-XL. Powder-Free sizes: S-2X. Ambidextrous. 100 gloves per box. 5 mil thick. 10" L

Description	Item	Price 100/pk
Powdered	6R1-GL159	\$18.89
Powder-Free	6R1-GL160	\$20.29+



Visit us online for pricing on additional options.



Provides a flexibility with a snug fit

Best



Best® N-DEX BWC (Because We Care) Pink Nitrile Gloves

Feel better by saving lives and supporting breast cancer research! Best Gloves will donate a portion of the proceeds to breast cancer research and awareness.

- Certified NFPA 1999 Emergency medical Operations
- 100% nitrile glove; powder-free
- Textured fingertips
- Class 1 Medical device

Sizes: S-XL. Ambidextrous. 100 gloves per box. 4 mils thick. 9½" L

6R1-GL390 \$19.89



Fire-Dex

SAVE MORE THAN
\$115



Yellow
Black



Fire-Dex® Complete Firefighter Value Package

This complete head to toe package provides all the proactive apparel needed to fight fires. All equipment meets NFPA 1971, 2007 edition.

- **Coat/Pants:** (FE886 and FE887) Chieftain Nomex® 35M traditional style coat and regular rise pant with Nomex® IIIA outer shell and a thermal liner/moisture barrier of quilted Nomex® batt sewn to Stedair® 3000 coated on E89™. Color choice of Black or Yellow
- **Helmet:** (FE972) Fire-Dex® 911 Helmet with 4" visor. Modern style helmet with a compression molded fiberglass shell. Six way overhead suspension for a more customized helmet "ride". Color choice of Black, Red, Yellow or White
- **Hood:** (FE269) Classic Style Nomex®/Lenzing® hood. Elastic face openings and bottoms. Provides protection and comfort
- **Boots:** (FW651) Fire-Dex® Rubber Boots come with a rubber shin guard, protective steel toe, plate and shank, wool lining, heel reinforcement and aggressive tread. Sizes medium and wide 7-12, 13 and 14
- Allow 60 days for delivery from manufacturer

6R1-FE926 \$1399.99 SAVE \$115.66
\$1515.65 if purchased separately

Coat Only	6R1-FE886	\$612.89
Pants Only	6R1-FE887	\$426.29
Helmet Only	6R1-FE972	\$239.89
Hood Only	6R1-FE269	\$37.39
Boots Only	6R1-FW651	\$199.19

Black
Gloss Finish



3M



Gloss



Matte

Finish Choices

Black
White
Yellow
Red

Color Choices



Bullard® UST Helmets

Thermoglass (fiberglass) outer shell for durability with greater resistance to chemicals and extreme temps. Design prevents helmet from cracking and chipping.

- NFPA 1971, 2007 edition certified for apparel structural gear
- Sure-Lock® ratchet headband
- 3M™ Scotchlite™ reflective markings
- Nomex® chin strap (quick-release buckle and postman's fastener)
- Nomex® ripstop ear/neck protector
- Removable, fire-resistant, cotton brow pad
- Hard-coated, optically correct, traditional face shield goggles-and-eye shield style
- Patriotic brass eagle in leather front holder
- 2-year limited warranty
- Fronts sold separately
- Shield from rim to head: FE405, 5", FE857, 6"

Description

	Item	Price
5" Helmet (gloss finish) with Bourke Eyeshield & Goggles	6R1-FE405	\$375.79
5" Helmet (gloss finish) with Faceshield	6R1-FE404	\$248.69
6" Helmet (matte finish) with Faceshield	6R1-FE857	\$232.39
Leather Helmet Front	6R1-FE113	\$56.49
Leather Helmet Front with Stamp Letters	6R1-FE406	\$61.99
Leather Helmet Front with Sewn Letters	6R1-FE407	\$78.49

★ PROPPER™

PROPPER™ Extrication Suit

Purpose-built with flame-resistant material and loaded with features to keep you safe and efficient during extrications.

- 7.7 oz, FR cotton blend 88% cotton/12% nylon
- 3" FR triple trim across back, around upper arms and leg cuffs
- Heavy-duty, two-way Aramid zipper front closure with hook-and-loop storm flap (fly area - no hook-and-loop for easy access)
- Left chest radio pocket
- Right chest oversized utility pocket
- Scissor pocket with straps over semi-bellowed cargo pockets on both thighs
- Hook-and-loop adjustable throat latch
- Mic clip above radio pocket
- Lined and reinforced padded elbows and forearms
- Hook-and-loop adjustable cuff closures
- Hook-and-loop adjustable take-up straps at waist
- Padded knees and shins
- 12" leg zipper with hook and loop adjustable straps at ankle



Khaki



Navy
Back

Colors: Khaki, Navy
Sizes: S-2X Short, S-6X Regular, M-4XL Long
6R1-FE212 \$199.99

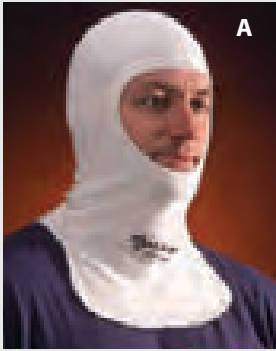

A

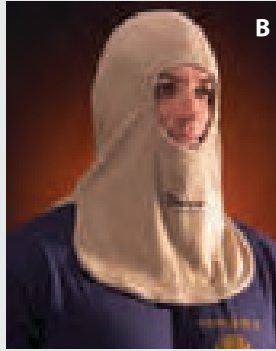

B

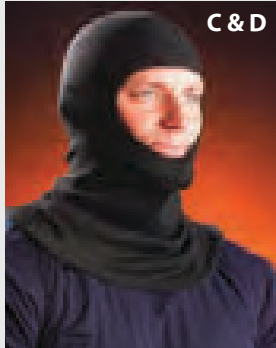

C & D

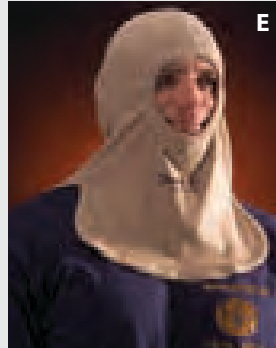

E

Galls® Hoods

Whether it is the cost-effective Nomex® blend or the maximum protection of deluxe 100% PBI®, Galls has a hood to meet your protection needs.

- NFPA 1971, 2007 edition
- PBI® provides the best flame protection available
- Carbon X hoods offer 2 breathable layers and a thermal barrier to shield your neck
- Deluxe styles have a longer hood for maximum coverage and better neck and shoulder protection

Made in the USA

Description	Item	Price
A) Classic Nomex®/Lenzing	6R1-FE269	\$37.39
B) Deluxe PBI®/Lenzing	6R1-FE370	\$47.59
C) Classic Carbon X	6R1-FE623	\$49.79
D) Deluxe Carbon X	6R1-FE624	\$55.39
E) Deluxe 100% Lenzing	6R1-FE409	\$60.89

VISIT US ONLINE



Shop our full line of fire fighting gear online at: galls.com/fire-rescue-gear



Galls® Deluxe SCBA Mask Bag

Made of rugged nylon and a padded interior, the Deluxe SCBA Mask Bag can withstand tough environments while keeping your mask properly protected and scratch free. Drawstring closure, metal hook for clip on gear and subdued gray label.

Black. 14"H x 9"W x 9"D. 1,134 cu in

6R1-FE674 \$18.19



Galls® Customizable Deluxe Firefighter Bag

From the dedicated helmet pocket to the two inner mesh pockets, this bag makes separating and organizing equipment a snap!

- 900 denier polyester
- Main compartment zips open on 3 sides for easy access
- Pockets on both ends, including separate helmet pocket
- Leather-wrapped cargo handles on both sides
- Black padded ergonomic shoulder strap
- Heavy-duty zippers
- Waterproof bottom

Red. 16"H x 30"W x 14"D. 6,720 cu in. Add embroidery or heat transfer to your bag (see our bag customization options on p. 143)

6R1-BG197 \$79.99



Convenient Helmet Pocket

TSA™ Hi-Vis Reflective Large Gear Bag

This Hi-Vis Gear Bag helps you haul all your gear and really boost your visibility.

- Durable 900 denier polyester on PVC upper and reinforced double PVC coated hard nylon bottom;
- Hi-Vis lime green and reflective striping
- Sturdy web carrying handles with hook-and-loop closure
- Large center compartment with U-shaped heavy-duty zipper
- 3 large ventilated pockets and 2 zipper pockets for smaller items
- ID pocket for easy identification

Hi-Vis Lime/Black. 15"H x 32"W x 15"D. 7,200 cu in

6R1-BG615 \$57.89



TSA™ Hi-Vis Reflective Step-In Boot Bag

Step right into your gear with this boot bag.

- Durable 900 denier polyester on PVC upper and reinforced double PVC coated hard nylon bottom;
- Hi-Vis lime green and reflective striping
- Sturdy web carrying handles with hook-and-loop closure
- Main compartment with heavy-duty zipper closure includes 4 ventilation holes and 2 outside pockets; ID pocket for easy identification

Hi-Vis Lime/Black. 17"H x 18"W x 20"D. 6,120 cu in

6R1-BG616 \$39.59



Galls® SCBA Mask Bag

Bag is constructed of durable 1000 denier nylon and has a soft interior lining for even further protection. Hook-and-loop closure.

Red. 14"H x 8"W x 8"D. 896 cu in

6R1-BG027 \$15.99



NFPA Approved Fire Boots



Fire-Dex® FDXL NFPA Leather Fire Boots

These traditional style fire boots offer protection with the comfort of a lightweight boot.

- NFPA 1971, 2013 edition and CSA compliant
- Steel toe
- Waterproof
- Lenzi puncture-resistant fabric insole protects foot from nails and other puncture hazards
- Tri-Laminate Lunar Liner System for thermal and moisture protection
- The Lunar facecloth is treated with Agion™, an antimicrobial technology that stops the spread of odor causing bacteria
- Vibram® Fire and Ice slip-resistant sole
- Goodyear Welt construction; DuPont™ KEVLAR® stitching
- Multiple ribbed steel shank

Men's Sizes: medium width in whole sizes 4-16 and half 8½-13½; wide in whole sizes 8-16 and half sizes 8½-13½; extra wide in whole sizes 8-14 and half sizes 8½-11½

6R1-FT022 \$259.99



Thorogood™ 14" Pull On Boots

The only pull-on boots on the market with a heat-, abrasion- and cut-resistant DuPont™ KEVLAR®/Vibram® rubber outsole.

- NFPA 1971, 2013 Edition & UL Classified; NFPA 1999 Certified for USAR
- Flame and cut-resistant leather upper
- Waterproof
- Safety toe meets or exceeds ANSI standards
- 5 IronTexon Shin Guard for better protection
- Long-wearing "Shark Skin" scuff-resistant leather toe
- Waterproof SympaTex® lining meets NFPA requirements but at a great cost savings
- Comfort weave lining wicks away moisture to keep feet cooler/drier
- Goodyear® storm welt construction for a long lasting, durable boot

Men's sizes: medium in 7-13, wide width in 9-13

6R1-SP517 \$330.29



Thorogood™ 14" Power HV NFPA Structural Bunker Boots

Thorogood Power HV Structural Bunker Boots provide complete protection at a great price.

- NFPA 1971, 2013 edition
- Meets ASTM-F2413-05 safety toe standards
- Meets CAN/CSA-Z195 electric shock resistance
- Steel shank and safety toe
- Cambrelle®/Sympatex® waterproof barrier lining
- Vibram® fire and ice slip resistant sole
- Bloodborne pathogen compliant
- Abrasion resisting rubber toe and heel protection
- 3M™ Scotchlite™ reflective material
- Super reinforced leather pulls

Men's Sizes: medium, wide and extra wide widths in 5-15

6R1-FW103 \$269.00



Black Diamond® X2 Leather Fire Boot

Combines advanced design with traditional materials for the ultimate combination of comfort and protection.

- Meets NFPA 1971 for structural fire fighting
- Steel toe meets or exceeds ASTM standards
- Firetuff leather upper with fusion fabric
- Exclusive 3-Point Heel Lock System
- Crosstech™ fabric Lining
- DuPont™ KEVLAR® Lining
- Padded shin-guard protection and comfort

Men's Sizes: medium width in whole sizes 4-16 and half 8½-13½; wide in whole sizes 8-16 and half sizes 8½-13½; extra wide in whole sizes 8-14 and half sizes 8½-11½

6R1-FW654 \$395.89

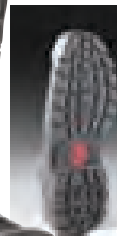

Fire-Dex® Leather Structural NFPA Fire Boots

Multi-density footbed for impact absorption, as well as a 3D vulcanized rubber heel and toe guard to give you top-notch comfort and protection all day.

- NFPA 1971, 2013 edition
- Flame-resistant full grain leather and reflective trim for enhanced visibility
- Vibram® sole with diamond plated ladder shank area for increased traction when climbing ladders
- Breathable Crosstech® waterproof barrier lining
- DuPont™ KEVLAR® lining for thermal and cut-resistant barrier

Men's Sizes: medium and wide widths in 7-12, 13 and 14

6R1-FW144 \$330.39

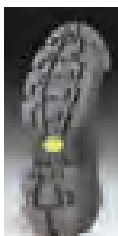

VISIT US ONLINE



Shop our full selection of boots online at:
galls.com/boots

in Traditional and Modern Styles



3M

Thorogood™ Hellfire Knockdown Elite NFPA Leather Fire Boots

Constructed of waterproof, flame and cut-resisting leather, this boot is dual certified for both Structural Fire Fighting and Liquid Splash-Protective Ensembles and Clothing for Hazardous Materials (HAZMAT).

- Meets NFPA 1971, 2013 edition for structural fire fighting
- Meets NFPA 1992, 2012 edition for HAZMAT
- Meets ASTM-F2413-11 CSA Z195 for safety toe standards
- Bloodborne pathogen compliant
- Composite toe
- Features rugged pull straps designed that are designed to stay flush
- StedAir® PTFE Waterproof barrier lining
- Steel triple ladder shank
- Abrasion resistant rubber toe and heel protection
- 3M™ Scotchlite™ reflective material
- Dual density Polyurethane removable footbed on reinforced Bi-Fit insole platform

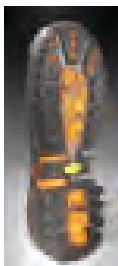

Men's Sizes: medium, wide and extra-wide widths in 5-16

6R1-FT023 \$414.19



HAIX® 11" Fire Hero Xtreme Leather Fire Boots

Gives you the grip you need to be prepared for any situation. This boot has features that you can count on - durability, comfort and superior function.

- Protective carbon HX safety toe cap meets toe protection standards CAN/CSA Z195-2009 and ASTM F 2413-05
- Meets National Fire Protection Association Standards: 1971-2013, 1992-2012
- Waterproof leather upper
- HAIX® Sun Reflect keeps feet cooler in direct sunlight
- Crosstech® inner liner; waterproof, breathable, bacteria, chemical and bloodborne pathogen resistant
- HAIX® Micro Soft Light System provides shock absorption and insulation
- Puncture resistant sole grips on water, ice, and snow



Men's Sizes: narrow medium and wide widths in 4½-3½

6R1-FW473 \$429.00



Thorogood™ Hellfire 14" NFPA Lug Boots

Stainless steel midsole insulates from heat and electrical currents.

- NFPA 1971, 2013 edition
- Cushioned shin guard with rung-gripping texture
- Waterproof
- Felt lining in leg and cotton knit lining in forefoot
- White molded outsole has firm traction with a "sticky" rubber compound
- High-temperature reflective stripe across front of foot and reflective patch on back of heel

Men's sizes: medium in 7-13, wide width in 9-13

6R1-SP564 \$135.00

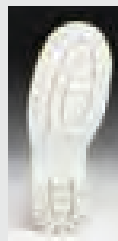

Black Diamond® 945 Rubber Fire Boots

Designed for maximum comfort and accurate fit.

- Meets NFPA 1971 for structural fire fighting
- A larger, naturally shaped steel toecap is used to allow complete freedom of toe movement
- Anatomically tapered heel area eliminates "heel slip"
- Removable Ortholite footbed is breathable, long-lasting and durable
- DuPont™ KEVLAR®/Nomex leg lining
- Rubber coated pull on loops for durability

Men's Sizes: medium width in whole sizes 4-16 and half 8½-13½; wide in whole sizes 8 - 16 and half sizes 8½ - 13½; extra wide in whole sizes 8 - 14 and half sizes 8½ - 11½

6R1-FW652 \$167.99

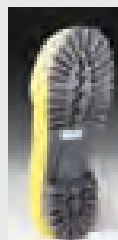

Honeywell

Honeywell Ranger 16" Insulated Wool-Lined NFPA Fire Boots

Shoe-Fit™ construction means this boot fits snugly to provide both protection and comfort!

- Meets NFPA 1971 for Structural Firefighting and 1992 for Liquid Splash for Hazardous Materials
- Wool felt lining for thermal insulation
- Shin guard; removable insert
- Steel bottom plate, toe and shank

Men's sizes: 7-13 narrow, medium, wide

6R1-FW587 \$179.99

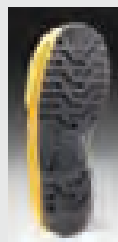

Honeywell

Honeywell Ranger Insulated DuPont™ KEVLAR® Lined Fire Boots

Lightweight, insulated Shoe-Fit construction.

- Meets NFPA 1971 for structural firefighting and 1992 for liquid splash for hazardous materials 16" height
- DuPont™ KEVLAR®/Nomex lining
- Shinguard
- Shoe-fit construction
- Steel bottom plate, toe and shank
- Removable Insert

Men's Sizes: narrow medium and wide widths in 7-13

6R1-FW588 \$190.59

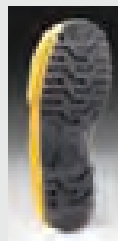

Vital Equipment for

NEW



Res-Q-Me resqHammer™

A modern-looking rescue hammer, this safety tool features an ergonomic design for a steady grip and a knuckle guard for hand protection. The stainless steel hammerhead quickly breaks car side windows, while the razor-sharp blade cuts effortlessly through seatbelts. Simply install in your vehicle with the included mounting bracket to keep within arm's reach.

- Polypropylene plastic/stainless steel construction
- Ergonomic design
- Knuckle guard
- Mounting bracket (included)

6½" x 3" x ¾"D. 3.3 oz

6R1-FE290 \$18.29



Galls® Emergency Hammer

Smash or cut your way to safety with the Galls Emergency Hammer!

- Equipped with 2 glass-shattering steel contact points as well as a seat belt cutter
- Lightweight, durable, plastic
- Includes mounting bracket for inside vehicle

Orange. 7½"L. 5.25oz

6R1-FE334 \$13.69



Works on any door hinge



Yellow

Fat Ivan® Fold-Up Door Chock

An open door could be the difference between life and death. The simple, compact and lightweight Fat Ivan holds any door open! Folds up to easily fit in a pocket and never damages the door or jamb.

- Strong, durable, engineered plastic and steel
- Includes magnets for storage on metal door frames
- Works on any door hinge
- Lightweight

4"H x 2"W x 1"D. 5 oz

Colors: Black, Pink, Red, White, Yellow

6R1-FE955 \$17.49



Galls® Standard Window Punch

This standard window punch has a stainless steel point for accurate penetration. Perfect for rescue, when seconds count. 5½"L.

6R1-FE001 \$9.89

Key ring not included



Seat Belt Cutter

Window Punch

TFT Res-Q-Me

Has a spring-loaded stainless steel window punch that will break most auto safety glass.

- Includes seat belt cutter
- Fully functional under water
- Safe to carry in pocket

1½"H x 3"W

6R1-FE388 \$11.19

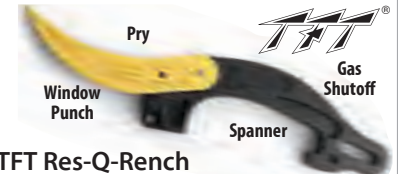

TFT Res-Q-Rench

Includes gas shutoff tool, pry tool, seat belt cutter, spanner wrench and window punch.

- Spanner wrench fits 1½" and 2½" rocker lugs, 4" and 5" Storz couplings
- Polycarbonate with carbide tip window punch

Open: 12¼"L. Closed: 8"L. 5 oz

6R1-FE297 \$27.69



Seat Belt Cutter

Check out more knives & tools starting on p. 214

We Accept these Major Credit Cards



ZAK Tool® Black Alloy Halligan Tool

Perfect for gaining entry into buildings, vehicles and other locked enclosures.

- Heads forged from heat-treated 4130 alloy steel
- Lightweight sure-grip knurled handle
- Pry foot has high arch fulcrum point for increased lifting and prying force
- Pointed tang can be used for prying, digging, pulling or puncturing
- One piece tool construction

Black. Lengths: 24", 30", 36"

6R1-FE044 \$206.99



Leatherhead Tools Halligan Bars

The strong Leatherhead Tools Halligan Bars are perfect for ventilation, forcible entry or overhaul.

- Meets or exceeds ANSI specs GGG-B-101 for hardness
- Drop forged with high carbon steel; Heat treated and zinc plated
- Finger grip for secure hold

Made in the USA

\$287.79

30" **6R1-FE863**

36" **6R1-FE864**



Emergency Entry and Rescue



Bullard® Eclipse Thermal Imager with Powerhouse Charger

Designed to fit in turnout gear pockets, the Bullard Eclipse Thermal Imager provides quality images at an affordable price, making it a must for every firefighter. Powerhouse charger recharges batteries in two hours.

- Eclipse Powerhouse charger meets NFPA 1901 requirements
- Ultra-small form factor
- Lightweight
- Large, glove-friendly, easy one-button operation
- 1000 degree dynamic range
- 80 x 60 array
- Includes Eclipse Control Panel software system



1.5 lbs. Includes desktop charger with 1 battery

6R1-FE878 \$4794.99

Bullard Eclipse Thermal Imager without Powerhouse Charger **6R1-FE877 \$4494.99**



Petzl® Rope Bucket

Durable, abrasion-resistant nylon bag includes webbed handles and adjustable shoulder strap. Holds up to 200 feet of ½" rope.

- Stands upright and has an exterior folding lid
- External zippered pocket
- 2 large, comfortable carrying handles
- Coated, waterproof fabric

6R1-FE643 \$50.95



Petzl® AM'D TRI-AC'T Aluminum Carabiner

This asymmetrical aluminum carabiner features a Keylock system to prevent snagging.

- 21mm gate opening
- 6,295 lbs. strength
- Weighs 2.7 oz

6R1-FE635 \$19.95



PMI® ½" Kernmantle Rescue Rope

These ½" (12.5 mm) PMI® Kernmantle rescue ropes conform to standards set for all two-person rescue ropes. Available in 150' or 200' lengths.

- UL certified to meet all NFPA 1983-06 class G standards
- 9100 lbs minimum breaking strength and 600 lbs. working load
- 100% nylon construction
- Less than 2% elongation at 200 lbf (0.889 kN) load, 17% at 75% of minimum breaking strength, less than 20% at failure

150': Blue, Olive Drab, Orange, Red, White, Yellow

6R1-FE213 \$195.49+

200': Blue, Orange, Red, White

6R1-FE171 \$260.69+



Visit us online for pricing on additional options.

Galls® Water Rescue Kit

Provides rescuers with everything they need to perform a shore-based rescue.

- Contents come inside a nylon mesh bag
- Mesh design allows gear to air out and dry quicker
- Adequately sized for numerous supplies

6R1-FE246 \$138.39



Water Rescue Kit Contents

- 1 Mustang Survival General Purpose Vest (one size fits all, USCG approved type III)
- 1 Rescue Mate™ Throw Bag with 70' of ¾" braided, polypropylene rope
- 1 USCG accepted orange whistle
- 1 10-pack of yellow light sticks at night
- 1 Thermal space blanket
- 1 Nylon mesh bag

Mustang Survival Throw Bag

Compact, lightweight and easy to use, the Mustang Survival Throw Bag is a must have for First Responders.

- 75' of 9mm multi-filament polypropylene Cordura® rope
- Quick release buckles
- Mesh top for quick drying
- Retro-reflective tape
- Light stick holder

Red/Black

6R1-FE898 \$50.99



Mustang Survival Universal Fit Industrial Foam Vest

Universal Fit Flotation Vest provides industrial strength protection with large armholes for added mobility.

- USCG - UL1123 - Marine Buoyant Devices 160.064 - Type III
- Adjustable straps provide universal sizing
- SOLAS reflective tape on the shoulders for better visibility in dark conditions

Orange

6R1-FE896 \$41.99



Protect Your Hands with



HexArmor® EXT Rescue® 4012 Extrinsication Gloves

Delivers safety and comfort with a pre-curved design and ISEA Level 5 cut-resistant palm.

- SuperFabric® brand material palm provides ISEA Level 5 cut resistance
- Back-of-hand impact protection system dissipates forceful blows over a large area
- Printed PVC synthetic leather palm provides reliable grip in dry or light oil situations

Hi-Vis Yellow. Sizes: S-2X, see size chart P on p.145

6R1-GL612 \$41.99



HexArmor® EXT Rescue® 4013 Extrinsication Gloves

Adaptable, versatile, and dexterous with an anti-debris SlipFit® cuff, for rapid on and off between missions.

- SuperFabric® brand material palm provides ISEA Level 5 cut resistance
- Back-of-hand impact protection system dissipates forceful blows over a large area
- TP-X® palm and fingertip reinforcement for the highest-level of abrasion resistance while maintaining an oil-resistant grip

Hi-Vis Yellow. Sizes: S-2X, see size chart P on p.145

6R1-GL613 \$44.99



HexArmor® EXT Rescue® 4011 Extrinsication Gloves

The strongest, most dependable rescue safety glove available. Built to last with double-stitched exterior and interior seams.

- SuperFabric® brand material palm provides ISEA Level 5 cut resistance
- Full Impact Exoskeleton™ with high-performance IR-X® smash guards
- TP-X® palm and fingertip reinforcement for the highest-level of abrasion resistance while maintaining an oil-resistant grip
- Breathable Airprene™ VELCRO® brand cuff for improved fit and comfort

Hi-Vis Yellow. Sizes: S-2X, see size chart P on p.145

6R1-GL611 \$50.99



HexArmor® EXT Rescue® Barrier 4014 Gloves

Comfortable, highly-protective and meets OSHA requirements for bloodborne pathogen resistance.

- Waterproof H2X™ barrier lining passes ASTM F1670/F1671 requirements and meets OSHA Bloodborne Pathogen Standards (29CFR 1910.1030)
- SuperFabric® brand material in the palm provides ISEA Level 5 cut resistance
- Sewn-in liner won't pull out when you remove the glove
- TP-X® palm material for abrasion-resistance and positive grip
- Back-of-hand impact protection prevents smash injuries
- SlipFit® cuff, for rapid on and off between missions

Hi-Vis Yellow. Sizes: S-2X, see size chart P on p.145

6R1-GL614 \$52.99



Nomex® Knit



Honeywell

Honeywell 7500 Series NFPA Gloves

Cowhide offers compliant performance while SEF thermal lining provides flexibility, comfort and excellent insulation.

- NFPA 1971, 2007 edition
- OSHA compliant
- Polyurethane moisture barrier

Sizes: S (7" - 8"), M (7½" - 8½") L (7¾" - 8¾"), XL (8¼" - 9½"), 2X (9½" +)

Description	Item	Price
Nomex® Knit	6R1-GL278	\$58.99
Leather Gauntlet	6R1-GL279	\$56.99



Leather Gauntlet



Honeywell

Honeywell Super Glove

Natural feel and easy movement.

- NFPA 1971, 2007 edition certified for apparel structural gear
- Kangaroo leather outer shell and cowhide cuffs
- Digiroo™ high grip palm and fingers
- Lined with a Crosstech™ Moisture Barrier for comfort
- Wool 3-D Heat Guard on back of hand for extra insulation
- 3-D Air Assist™ thermal lining for protection without bulk

Sizes: S-2X

6R1-GL333 \$133.99



Extrication Gloves



Long Wrist
Yellow



Short Wrist
Yellow



Ringers® Extrication Gloves

Puncture-resistant and tough, these gloves are designed to meet the needs of extrication.

- Keprotec® DuPont™ KEVLAR® reinforced pads are puncture resistant
- 100% Clarino palm and fingers

Colors: Black, Yellow. Sizes: S-2X, see size chart O on p.145

Description	Item	Price
Long Wrist	6R1-GL136	\$55.89
Short Wrist	6R1-GL135	\$50.79



Short Wrist
Black



Yellow



Red



3M

Ringers® SuperCuff Rescue Gloves

Experience the Ringers SuperCuff Rescue Gloves protection, agility and tactile sensitivity required to handle any situation.

- Direct inject Thermal Plastic Rubber (TPR) finger panels for superior protection
- DuPont™ KEVLAR® palm panels provide cut resistance
- Patented SuperCuff Technology
- 3M® reflective striping for increased visibility
- Gel padding reduces vibration and injury
- Anatomic cutouts offer restriction-free gripping
- Reinforced stitching and hidden seams; 6 mm segmented padding across knuckles

Colors: Red or Yellow. Sizes: S-2X, see size chart O on p.145

6R1-GL336 \$36.29



Ringers® Barrier I Extrication Gloves

The breathable Hipora® barrier in this glove keeps out micro organisms for your increased safety and comfort, including guarding against TB and HIV.

- Meets OSHA standards 29CFR 1910.1030
- Waterproof
- Cut-resistant DuPont™ KEVLAR® panels
- Boxed fingertip design
- Molded TPR (Thermal Plastic Rubber) knuckle and fingertips

Yellow/Black. Sizes: S-2X, see size chart O on p.145

6R1-GL277 \$70.99



Shelby Xtrication Gloves

Shelby Xtrication Gloves provide the functional mobility and protection required by emergency service professionals.

- Cordura® material
- Keprotec® and DuPont™ KEVLAR® puncture-resistant palm, fingers and knuckle pad provide added security for your hands
- Xstreamlight® light feature has VELCRO® brand attachment (light not included)
- Reflective trim
- Elastic wrist

Yellow/Black. Sizes: S-2X, see size chart O on p.145

6R1-GL184 \$57.50



HEL-FIRE Firefighter Glove Holder

This firefighter's glove holder is made of 100% high-strength, flame-resistant hardware to give you superior protection when responding to hazardous rescue operations.

- 100% DuPont™ KEVLAR® webbing for unparalleled fire resistance
- Industrial-grade die cast zinc trigger snap for ease in attaching turnout gear
- Dual-sided release buckle easily adjusts to various glove sizes
- Metal military-style webbing end tips to prevent fraying

Made in the USA. Black. 1" W

6R1-GL376 \$13.89

Galls® Deluxe Glove Holder with Carabiner

VELCRO® brand overlap closure on 1½" nylon webbing provides a easy access to gloves. Durable aluminum carabiner stays clipped to your rig.

Black

6R1-GL257 \$11.99



Galls® Nylon Glove Holder

Nylon VELCRO® brand strap with metal hook keeps gloves close and accessible.

Colors: Blue, Red, Yellow, and Black

6R1-GL258 \$7.59



Essential Tools



Top Dawg® EagleEye 1080p Dash Cam

Ready to use right out of the box, EagleEye is a cinch to operate, and it installs in minutes.

- Plastic construction
- 1080P HD 120 degree wide angle camera
- 2.7" TFT LCD screen
- IR light enhances recording in low-light conditions
- G-sensor detects collisions, saves 20 seconds of video before and after impact
- Rechargeable 180mAh Li-Polymer battery
- Recording time on 8 GB card: 70-80 minutes (at 1280 by 720)

2¼"H x 3½"W x 1½"D

6R1-VE700 \$70.99



PRO-VISION® Video Systems

PRO-VISION® In-Car Video System

With a reliable solid state DVR, powerful high-resolution recording software and unlimited installation options, this video system is the state-of-the-art solution for today's law enforcement professionals. The system continuously loop-records up to 260 hours of HD footage in a ready-to-view AVI format on the removable SDXC memory card. With high speed file transfers and no fragile moving parts, the solid-state system saves you time and money compared to hard disk and server-based systems. Choose your ideal configuration below.

- Aluminum-cased solid state DVR with lockable cage (expandable up to 2 TB)
- 64 GB SDXC class 10 memory card
- 27x zoom dash camera with Sony® CCD technology
- 2.4 GHz wireless microphone system (transmitter, receiver, lapel mic, belt pouch)
- 10m AV cable; software and guides



27x Optical Zoom Camera



LW192 Mirror Display



LW195 mounted monitor

Description

Description	Item	Price
1 Camera, 5" Monitor	6R1-LW191	\$3233.99
1 Camera, Mirror Monitor	6R1-LW192	\$3294.99
2 Cameras, 5" Monitor	6R1-LW193	\$3452.99
2 Cameras, Mirror Monitor	6R1-LW194	\$3513.99
1 Camera, 5" Monitor (Motorcycle)	6R1-LW195	\$3294.99



Code 3® Portable Work Light

High intensity scene lighting or additional scene warning wherever it's needed. Features a versatile magnetic base to position the light anywhere on the outside of a vehicle.

- Aluminum heatsink housing, stainless steel bracket, polycarbonate lens, magnetic base
- Five 3-watt LEDs
- High intensity, 600 lumens flood beam
- 5 operating modes
- 100% and 30% flood with steady burn red and white, quad red and double red
- Rechargeable lithium rechargeable battery
- Run time on battery is 3 to 4 hours, charge time less than 7 hours
- Includes cigarette plug and AC plug charger

9"H x 4½"W x 4"D

6R1-SL048 \$126.89

for Precision Enforcement



Kustom Signals® Raptor RP-1 Radar

Displays full text messages rather than three-letter abbreviations. Low-light feature allows selection of negative display that helps reduce nighttime eye fatigue. Allows complete enforcement control from the front panel.

- Meets IACP and NHTSA regulations
- DuraTrak™ target tracking bars for better tracking history
- Digital Signal Processing (DSP) reads and identifies all signals
- Moving/stationary directional modes (All, Approaching Only, Receding Only)
- Fastest target modes
- TruTak™ with automatic mode switching
- Smart Patrol Search to eliminate patrol shadowing and combining
- Waterproof directional K-band antennas designed to reduce current draw without affecting performance

Made in the USA. 2¾"H x 4⅞"W x 1½"D

Description	Item	Price
Single K Band with Directional Mode	6R1-LE951	\$1485.29
Single K-Band with Directional and Same Lane Mode	6R1-LE952	\$1697.29
Dual K-Band with Directional Mode	6R1-LE953	\$1956.79
Dual K-Band with Directional and Same Lane Mode	6R1-LE954	\$2070.59



In-car video integration



Kustom Signals® Golden Eagle II Radar with Dual Antenna

Capture faster and more precise target acquisition.

- Meets IACP and NHTSA regulations
- One of the longest shooting ranges
- DSP (Digital Signal Processing) Technology
- K and Ka-band technology
- Intuitive radar learns driver's habits, eliminates shadowing and combining
- Includes: antennas, wired/wireless remote, mounting brackets, tuning forks, power cable and operator's manual

Console: 1¾"H x 6½"W x 1¼"D. Antenna: 2½"H x 2½"W x 3¾"D

6R1-LE876 \$2694.99



Kustom Signals® Falcon HR Radar

Identify the fastest vehicle with the advantage of technology.

- Meets FCC IACP and NHTSA regulations
- K-band technology
- DSP (Digital Signal Processing) Technology reads and identifies all signals
- Directional stationary, displays fastest vehicle
- Operates corded or cordless with purchase of LE882 below

3¾"H x 3"W x 6¾"D. Handle: 5¾"H x 3½"W x 3⅞"D.

Weight: 2 lbs with corded handle

6R1-LE877 \$908.89

Battery Handle/Charger 6R1-LE882 \$314.99

Replacement Battery 6R1-LE883 \$208.99



Digital Signal Processing Technology reads and identifies signals



Wireless Stryker



RadioRay



Standard Portable

GoLight® Spotlights

These powerful spotlights can be mounted permanently or temporarily on the outside of your vehicle. You maintain control via remote from inside or out. GoLight® projects a beam up to ½ mile. All but the Gobeer rotate 360° and tilt 135°; use 12V cord, water-resistant.

Wireless Stryker: Provides 500,000 CP; two-step installation; features dash-mount option and innovative mounting plate with clamping interface. Wireless remote with 100' range; 15' cord with cigarette plug for 12V DC.

7"H x 7"W x 7½"D

6R1-SL082 \$349.99

RadioRay: Provides 400,000 CP; has a magnetic mount shoe and suction cup. Programmable wireless remote; 15' cord with cigarette plug for 12V DC.

Colors: Black, White. 8"H x 8"W x 8¾"D

6R1-SL090 \$274.99

Standard Portable Wired: Provides 400,000 CP; includes suction cup and permanent mounting shoe. 15' cord with cigarette plug for 12V DC.

8"H x 8"W x 8¾"D

6R1-SL066 \$149.99

65W Halogen Replacement Bulbs

SL082 6R1-BU226 \$14.89

SL066 & SL090 6R1-BU227 \$14.89

Air Compressor

Built-in Converter



Internal Battery

Jump Starter



Schumacher® Jump Starters

Schumacher Jump Starters offer the power and convenience you need. For more details on each jumpstarter, visit galls.com. *Sales prohibited in the state of California.*

SL1 Jump Starter: Weighing only 1.7 lbs, the SL1 is 90% lighter than lead-acid jump starters. TSA checkpoint friendly for portable power wherever life takes you.
2¾"L x 8"D x 10¾"H. 1.7 lbs

6R1-VE590 \$141.99

With Air Compressor: 950 peak amps Instant Power™ with an air compressor. The 18 ampere hour battery will handle most anything. Battery power status indicator. 12V battery source with 28" cables.

11¾"H x 9¼"W x 7¾"D. 17 lbs

6R1-VE313 \$173.19

With Built-in Converter: 400W built-in converter to operate 120V household appliances. LED battery power status indicator. 12V flex light is included.

11¾" H x 9¼" W x 7¾" D. 17 lbs

6R1-VE314 \$210.79

With Internal Battery: 2200 peak amps Portable Power™ with a 22Ah internal battery. 300 cranking amps, 275 cold amps, high output AGM battery, 4 gauge with 50 inch cables.

4¾"H x 4¾"W x 14"D. 21.5 lbs

6R1-VE312 \$247.99

SETINA

Setina PB400 Steel Push Bumpers

Easily installed and engineered with one-piece steel construction.

- Black powder-coated finish for maximum durability
- Double crossbar for added protection to grille and headlights
- Will not interfere with SRS airbag system

Weight and size vary depending on vehicle. Specify vehicle make, model and year.

6R1-SS120 \$298.99

Add \$20 per bumper for freight



Setina BodyGuard 10-S Partition

Self-locking and easy to use, even with one hand. Plexiglass® or Lexan® window for added heat and shatter resistance. Comes with lockable slide window. Specify year, make and model of vehicle, electric or manual windows. SS073 fits most SUVs, trucks and vans.

Sliding window opens on passenger side only and can be opened and shut from front seat only



Description	Item	Price
Plexiglass® Screen	6R1-SS016	\$563.59
Lexan® Screen	6R1-SS015	\$608.99
Plexiglass® For Vans	6R1-SS073	\$668.49
Lexan® for Vans	6R1-SS073	\$709.69

Add \$50 per item for freight



Stinger Spike Systems

For quick deployment and safe retrieval, get the one-piece, preassembled 10' Metro Spike System or the 15' Trooper Spike System. Constructed of molded Dupont® Zytel® Flexible Nylon® and 100% stainless steel. Self-adjusting stainless steel spikes assure penetration. All include carrying case and 10 pack of replacement spikes.



Description	Weight	Item	Price
10' Metro	13 lbs	6R1-LE281	\$512.59
15' Trooper	15 lbs	6R1-LE339	\$636.59
Replacement Spikes		6R1-LE282	\$27.94/10 pk

SPiKE-DEVIL

Spike-Devil System

The Spike-Devil is designed to make setup, retrieval, and maintenance as fast and easy as possible. Stored in a portable holster, the lightweight system can be deployed in an instant, and is built to work whether spike-side-up or not.

- Small size opens up wide on roadway for optimum performance on a variety of hard surfaces and under most weather conditions
- 80' heavy-duty cord reel for safe, rapid retrieval
- Spikes are encapsulated in plastic to prevent damage to strip frame and officers
- Simple design allows for quick user maintenance
- Holster allows quick access and is transferable between all types of law enforcement vehicles
- Factory preassembled for functionality out of the box



Holster for easy transport and instant deployment

Description	Weight	Item	Price
Single lane	6 lbs	6R1-LW216	\$310.59
Two Lane	7 lbs	6R1-LW217	\$343.99
Replacement Spikes		6R1-LW218	\$16.00/8 pk

SETINA



Installs easily without drilling holes and can be removed for cleaning

Setina Window Barriers

Scratch-resistant, black powder-coated finish. Works with Setina® Door Panels. Comes in pairs. Specify make, model and year of vehicle.

6R1-SS122
Car **\$198.99**
SUV **\$208.99**

Add \$35 freight charge per pair

Setina Window Barriers fit in:

'00-'12 Crown Vics	'03-'15 Expeditions
'00-'14 Impalas	'13-'15 Ford Interceptor Sedan
'00-'15 Tahoes, Yukons and Suburbans	'13-'15 Ford Interceptor Utility
'02-'12 Explorers	



Shown with optional cupholder and armrest

JOTTO DESK®

Jotto Desk® 16" Contour Console F/Interceptor Sedan and Utility

Offers a 12" faceplate opening with a 26 degree viewing angle and a 4" horizontal faceplate opening — providing a total of 16" of mountable equipment space.

- Steel construction
- 16" of equipment mounting space
- Over 10" of equipment mounting depth at the top, 5" depth at the bottom
- Mounts on the transmission hump

20"L x 12"H x 10¾"W. 11.9 lbs. without faceplates; 13.9 lbs. with faceplates

6R1-VE381 \$419.89

Cupholder **6R1-VE382 \$57.59**

Armrest **6R1-VE002 \$114.99**



Contents not included

PRO COPPER®

Pro Copper® Console

Console attaches to front seat bolts and uses a side mounting system, eliminating the need for face plates.

- Black steel and durable polyethylene construction with rounded edges for safety
- Ergonomic design angled for visibility
- Close to the dash for easy accessibility
- Holds up to 5 electronic units
- One-piece unit can be easily transferred from car to car with equipment intact
- 2 convenient cup holders
- Fits: '92-'10 Crown Vic, '04-'15 Suburban/Tahoe, '09-'12 Impala

8½"H x 8½"W x 26½"L

6R1-VE013 \$309.59

Armrest with Flashlight Compartment **6R1-VE129 \$104.99**

ATTENTION Departments and Agencies
 We specialize in large orders to outfit your entire department or agency. Call 800.477.7766 today for discounts.

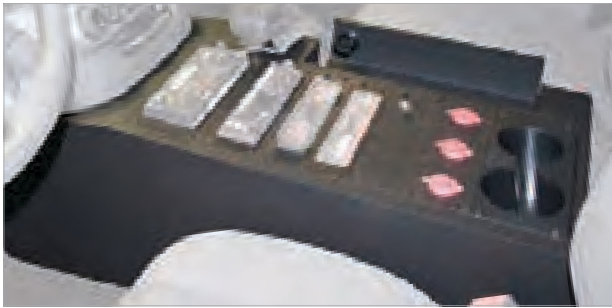

JOTTO DESK®

Jotto Desk® 20" Contour Console F/15+ Chevy Tahoe

Mounts up to 20" of radio and communications equipment. Wide footprint fills gap between seats to maximize usable space. Pre-drilled for fast and easy installation.

- Steel construction
- Front of console, 9" depth; rear of console, 6½" depth
- 28" Tahoe floor plate

30½"L X 10¼"H X 13"W. 13.75 lbs. Without faceplates; 18.75 lbs. with faceplates

6R1-VE137 \$749.79



JOTTO DESK®

Jotto Desk® Dodge Charger Horizontal Contour Console

Dash contouring shape and mounts up to 15" of equipment. Replace the factory floor plate in minutes using factory fasteners with top-down installation. No drilling required. Relocates the 2 OEM 12V outlets and USB port. Each console comes standard with 12" of faceplates, 3" blank faceplate and a built-in dual cup holder.

Front: 10"H x 11"W x 25"L. Rear: 7"H

6R1-VE316 \$419.99

Galls® Stacking Systems

Stack your units vertically or horizontally. Horizontal unit has unique pivoting hinge bracket to mount along any shaped surface. Installation is easy.

- Constructed of steel with durable, black powder-coat finish
- Includes spacer bars and hardware
- Air bag friendly

Vertical Systems

Units	Size	Item	Price
2-Unit	7"H	6R1-VE200	\$46.69
3-Unit	9"H	6R1-VE200	\$50.79

Horizontal Systems

3-Unit	10"L	6R1-VE201	\$70.69
4-Unit	12"L	6R1-VE201	\$75.99



Horizontal



Starting at
\$46⁶⁹



Vertical



TUFLOC

Tufloc® Overhead Gun Rack Without Partitions

Fits: Remington 870 or AR-15.
4¼"H x 5¼"W x 36"D. 11 lb

6R1-VP217 \$289.95



TUFLOC

Tufloc® Overhead Shotgun Rack for Partition

Fits: Remington 870 or AR-15.
4"H x 17"W x 5"D. 5 lb

6R1-VP216 \$219.95



TUFLOC

Tufloc® Gun Rack

Space saving mount fits AR15 Rifle and R870 shotgun.

- Includes gun lock
- Between the seat low-profile design
- Easily mounts to partition
- Powder-coated steel

Single Vertical: 17½"H x 5¼"W x 4¼"D. 5 lb

6R1-VP235 \$219.95

Double Vertical: 34"H x 9"W x 8"D. 18 lb

6R1-VP226 \$389.95

TUFLOC

Tufloc® Small Shotgun Lock

This dual-release lock can be accessed with a key or by using the electric 8-second delay timer.

- High-strength unit resists forced entry
- Soft lining protects weapon
- Black powder-coated aluminum
- Universal fit for all shotguns

3½"H x 2½"W x 3½"D.
2.5 lb

6R1-VP275 \$87.89



TUFLOC

Tufloc® Rifle Lock with Handcuff Key

Momentary switch allows easy access and handcuff keys can offer secondary unlocking options in case of power failures with this lock.

- Black powder-coated finish; felt lining protects firearm finish
- High-strength unit resists forced entry
- Adjustment plate in lock allows different weapon fits
- 1-year warranty
- Aluminum construction

5"H x 5"W x 5"D. 3 lb

6R1-VP232 \$109.95



TUFLOC

Tufloc® Delay Timer for Gun Locks

Timer has 8-second delay after activation and automatic relocking.

- Automatically closes after selected time
- Compatible with all gun locks

Black powder-coated aluminum. ½"H x 2"W x 2"L. .5 lb

6R1-VP276 \$35.99



JOTTO DESK

Jotto Desk® Universal Computer Floor Mount

Mounts to virtually any vehicle. Cable-Dock® securing system same as in the Jotto Laptop stand.

- 3" x 6" one-piece mounting base frees up leg room
- Telescoping rod extends height (17"-21"+), stores in stand that attaches to base for travel
- Design permits storage of computer against dash while driving
- Mounts on flat, angled or vertical surfaces
- Installation takes about 20 minutes. Drilling required

6R1-VE221 \$231.99



Jotto Desk® No-Holes Mount Laptop Stand

Keep your laptop handy when you need it and out of the way when you don't.

- Cable-Dock® securing system wraps 2 nylon-coated steel cables up and over the entire computer for a firm, positive grip; plus, it will secure any size laptop
- Installation takes about 20 minutes using simple hand tools with no drilling required
- Mount fits: Crown Vics (all), Impalas ('00 and up), Explorers ('02 and up), Expeditions ('03 and up), Durangos ('04 and up), Tahoes ('00 and up), Suburbans ('00 and up), and F250-550s ('00 and up)

Powder-coated steel. Specify make and model of vehicle

6R1-VE153 Starting at \$339.99+



Visit us online for pricing on additional options.

Keep Your Vehicle Clutter-Free & Organized



5.11 Tactical® Wingman Patrol Bag

Attaches to your passenger seat with a seat belt pass-through.

- 1200 denier polyester construction
- Loaded with internal and external web platforms and Backup Belt System™ panels
- Upper panels attach to the headrest
- WriteBar™ on the outside of the bag so you can write your name or other identifier on it
- MOLLE webbing on outside to allow you to attach MOLLE system pouches and accessories

13¾"H x 18½"W x 7½"D. 1,838 cu in

6R1-BG395 \$89.99

Shop more bags and organizers starting on p. 220



Galls® Soft-Sided Deluxe Seat Organizer

Bestselling organizer features 15 pockets in a variety of shapes and sizes.

- 600 denier polyester
- Large compartment ideal for files
- 2 pockets with drawstring tops
- Mesh sides for airing out items

18"H x 18"W x 4"D

6R1-VE185 \$31.49



Galls® Molded Organizer

Secures forms, clipboards, maps, flashlights, handcuffs and other equipment for fast, easy access.

- Built-in handle allows for easy transport
- Supplies stay put even at high speeds
- Low-density polyethylene material with adjustable metal brackets
- One-piece unit

21½"H x 15"W x 4"D

6R1-VE046 \$59.99



Galls® Deluxe Trunk Organizer

Large, roomy organizer comes with movable dividers that allow you to tailor compartment size to organize your gear.

- Made of 600-denier polyester with heavy-duty side panels to hold shape
- Unlike plastic organizers, it won't slide around in your trunk or scratch up your gear
- Easy-grip side handles
- Panels collapse down for easy storage
- Removable lid for easy access
- Designed to fit most cars and SUVs

8½"H x 40"W x 19"D. 6,460 cu in

6R1-VE260 \$174.79



JOTTO DESK®

Jotto Desk® Trunk Cargo Organizer

This modular organizer features three sections for organizing clutter in the trunk or cargo area of your vehicle.

- ABS plastic construction
- Hinged top and 3 adjustable sections
- Can be configured in different ways based on the vehicle model

9¾"H x 40½"W x 21"D. 8,292 cu in

6R1-VE575 \$149.99





**G4 LED
Single Head**



**G6 LED
Dual Head**

Galls® LED Dash Lights

These high performance LED dash lights come with the same low profile, but with your choice of light output. G4 dash lights come with four LED diodes in the single head and eight LED diodes in the dual head. Get even more light output with G6 dash lights that include six LED diodes in the single head and 12 LED diodes in the dual head.

- Comes in single or split color combinations; light is clear when off
- 25 customer selectable flash patterns
- 10V - 30V DC
- Suction cup dash, rear view mirror and deck mounting included

Single Head measures 1 1/8" H x 4" W x 3 1/2" D. Dual Head measures 1 1/8" H x 7 3/4" W x 3 1/2" D.
Dual Head Colors: ■ ■ ■ ■ ■ ■ ■ ■

G4 Dash Lights

Single Head	6R1-DL235	\$103.59
Dual Head	6R1-DL236	\$217.49

Cigar Plug
with On/Off Switch

G6 Dash Lights

Single Head	6R1-DL237	\$141.79
Dual Head	6R1-DL238	\$271.89
G4/G6 Headliner Bracket	6R1-DL247	\$11.79



Reflective decal
provides greater
intensity

Signal® StarBurst Mini-Phantom Dash Light with Reflective Hood

Our low-profile LED dash light is now available with high intensity, STAR Generation-3 LEDs and an optional reflective hood.

- Featuring 35 selectable flash patterns
- 6 high intensity STAR Generation-3 LEDs
- Includes reflective decal for removable shroud, providing even greater intensity!
- Comes with dash, deck, mirror or suction cup mounting for windshield

1" H x 9" W x 1 1/4" D. Colors: ■ ■ ■ ■ ■ ■ ■ ■

6R1-DL259 \$163.19



3M

Signal® SVP Dual Mini Phantom Headliner Mount LED

Get the bestselling power of the discreet Mini Phantom Dash Light in a convenient, easy-to-mount kit that packs a punch.

- Kit includes 2 Mini Phantom LED Dash Lights corded together with a cigar plug
- Includes special self-leveling brackets with 3M™ automotive grade tape to accommodate most windshield angles
- 8' cord with cigar plug

Made in the USA. Colors: ■ ■ ■ ■ ■ ■ ■ 7/8" H x 9" W x 1 1/8" D

6R1-DL269 \$211.19

Compact, Covert Warning Power



**EXCLUSIVE
ITEM**

\$94⁴⁹



Signal® Mini Phantom Max Plus Dash Light

You wanted more LEDs, so we gave you the Mini Phantom Max! You wanted to prevent “flash back”, so we added a removable shroud on the Mini Phantom Max Plus! Includes WASP (Wide Angle Signal Projection) Optics for even more warning power. Now, you can even select your pattern with a touch of a button on the cigar lighter plug.

- Exclusive WASP Optics for Wide Angle Signal Projection
- **FREE** intensity booster
- Extremely low profile; removable shroud
- 35 selectable patterns
- Comes with dash, deck, mirror or suction cup mounting for windshield.

Colors: ■■■■■■■■ 1" H x 9" W x 1 1/4" D

6R1-DL212 \$94.49

Shroud alone **6R1-DL208 \$11.79**

Visit galls.com for more information



Galls Exclusive WASP optics offer a powerful warning

Price Match Guarantee

We will match the price of an item found on the Internet for a lesser price and currently for sale by Galls. Some restrictions apply.



One Dash Light

Two Deck Lights

Signal® Mini Phantom Dash/Deck Combo Kit

Comes with Mini Phantom Max Plus Dash Light (see above) and a pair of Mini Phantom Max Plus Deck Lights (See GR308 on p. 302)

Colors: ■■■■■■■■

6R1-DL186 \$309.59 SAVE \$11

\$321.38 if purchased separately

Shroud alone **6R1-DL208 \$11.79**



Galls® Traffic Alert Kit

Traffic will clear a path for you when you have one of these kits in your vehicle.

Each kit includes:

- Galls 100W Speaker (SK144) – a neodymium driver that delivers a lot of volume for a small investment
- Galls Full Function Siren (SK124) – a loud traffic mover
- Mini Phantom Max Plus LED Dash Light (DL212) – comes with 35 selectable patterns and is 25% brighter than original Mini Phantom (see above)

6R1-DL193 \$392.39 SAVE \$32.88

\$425.27 if purchased separately

Versatile, Covert Lighting

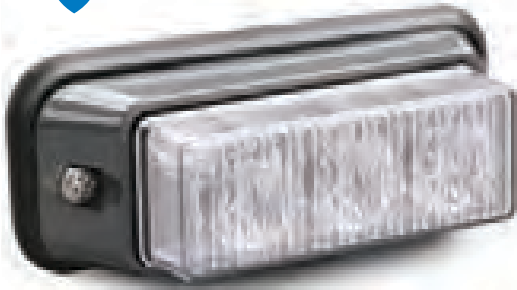

Galls® G3 Surface Mount LED Light

Bestseller! This compact grille light is so versatile it can be mounted inside or outside your vehicle.

- 12 flash patterns can be synchronized for simultaneous or alternating patterns
- Mounting brackets available below

Colors: ■, ■, ■, ■, □. 1½"H x 3½"W x 1¼"D

6R1-GR309

■, ■, ■, ■ \$48.29
□ \$53.59

SAVE with kit pricing.

2 LED Light Kit ■, ■, ■, ■, □ 6R1-GR045 \$94.89
 4 LED Light Kit ■, ■, ■, ■, □ 6R1-GR047 \$178.79



Compact LED delivers bright warning



WHELEN®

Whelen® TIR3 Series Surface Mount Module

Generation 3.5 LEDs, mountable inside or out, are great for use on the grille, side view mirrors, bumpers or even motorcycle fairings.

- 25 ScanLock™ flash patterns can be synchronized for simultaneous or alternating patterns with other TIR3 modules
- Moisture and vibration-resistant, made for heavy-duty application
- Built-in flange to make mounting easy

Colors: ■, ■, ■, ■, □. 1½"H x 3½"W x 1¼"D. Direct wire.

Optional mounting brackets, see opposite page

6R1-GR182 \$59.99

Whelen® LINZ6 Super-LED Surface Mount Lighthead

This sub-compact, full-featured LED lighthead with Whelen® patented Linear-LED wide-angle optics offers maximum visibility and can be mounted virtually anywhere.

- 6 LED diodes allow for 3 x 3 split patterns
- 69 Scan-Lock™ flash patterns, including steady-burn, alternating and simultaneous patterns
- Fully encapsulated electronics provide full moisture and vibration protection
- Surface mounted with no external flasher, easy to install
- 12V DC

Colors: ■, ■, ■, ■, □, ■, ■, ■, □. 2"H x 4"W x 1½"D. Optional mounting brackets, see opposite page

6R1-GR307 \$110.29



Sub-compact LED delivers maximum visibility

Brackets for TIR3, LINZ6 and G3 LEDs

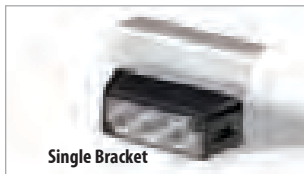

Single Bracket

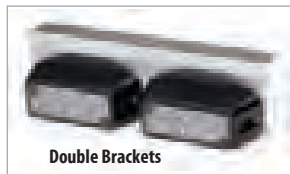

Double Brackets

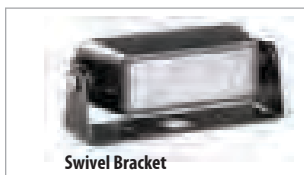

Swivel Bracket

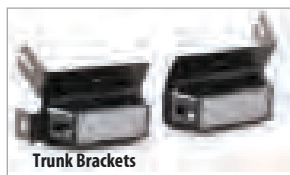

Trunk Brackets

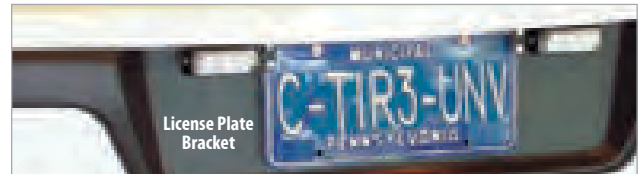

License Plate Bracket

Single Bracket	6R1-GR196	\$11.49
Double Brackets	6R1-GR195	\$17.49
License Plate Bracket	6R1-GR313	\$21.79
Swivel Bracket	6R1-GR260	\$32.69
Trunk Brackets	6R1-GR259	\$21.79/pr

Mounts Wherever You Need it



XT6 Single Deck Bracket

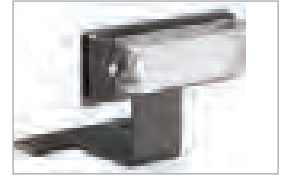

XT3 Single Bracket



XT3 Single Deck Bracket



XT4 Single Deck Bracket



XT3 License Plate Bracket

Code 3® Surface Mount LEDs

At only 1" deep, these make a great auxiliary or secondary warning light that can be mounted almost anywhere.

- 3, 4 or 6 powerful LEDs
- 12 flash patterns
- Direct wire
- Variety of compatible mounting brackets available

XT3 Colors: ■ ■ ■
 XT4 & XT6 Colors: ■ ■ ■ ■ ■ ■ ■ ■

Desc.	Size	Item	Price
XT3	1¼"H x 3½"W x 1"D	6R1-GR265	\$69.69
XT4	1¼"H x 4½"W x 1"D	6R1-GR302	\$73.49
XT6	1¼"H x 6¼"W x 1"D	6R1-GR303	\$102.99
XT3 Single Bracket		6R1-GR266	\$8.89
XT4 Single Deck Bracket		6R1-GR304	\$8.89
XT6 Single Deck Bracket		6R1-GR305	\$8.89
XT3 Single Deck Bracket		6R1-GR267	\$17.89
XT3 License Plate Bracket		6R1-GR268	\$33.69

Questions?

Our knowledgeable and helpful customer service representatives are available Monday-Friday 8:00 a.m. - 9:00 p.m. ET. Call 800.477.7766 to place an order, ask a question or learn more about our products.



License Plate



Dual L Horizontal



Dual L Vertical



Bail-Style



Trunk Mount



Universal L



Window Mount

Galls® Surface LED Light Brackets

Bail-Style Bracket	6R1-GR395	\$22.39
Dual L Bracket Horizontal	6R1-GR348	\$11.79
Dual L Bracket Vertical	6R1-GR349	\$11.99
License Plate Bracket	6R1-GR350	\$22.89
Trunk Mount Bracket	6R1-GR351	\$11.99
Universal L Bracket	6R1-GR352	\$11.99
Window Mount Bracket	6R1-GR353	\$11.99



Galls® Surface Mount LED Lights

These small profile, high performance LED lights offer great value and mount just about anywhere.

- GR330 has 25 selectable flash patterns, GR394 has 21 selectable flash patterns
- 10V - 30V DC
- Fully encapsulated and water resistant
- Interior and exterior mountable; optional mounting brackets available (see left)

Colors: ■ ■ ■ ■ ■ ■ ■ ■ 1"H x 3½"W x ¾"D

Description	Item	Price
G6	6R1-GR330	\$106.59
3 LED	6R1-GR394	\$57.89

High-Intensity LED Lighting

STAR SIGNAL

Signal® DLXT Thinline LED Light

Big LED brightness in a very small package. Option of split colors.

- 40 high intensity LEDs
- 11 selectable flash patterns can be synchronized
- Fully encapsulated circuitry and a weather-resistant housing
- Black bezel for neat and easy installation; interior or exterior mounting
- Universal L bracket available (GR311)

Colors: 2 1/4" H x 5 3/4" W x 1/2" D

6R1-GR312 \$58.69

L Bracket for Universal Mounting **6R1-GR311 \$11.69**



Interior or Exterior Mounting Options

CODE 3®
A PUBLIC SAFETY EQUIPMENT COMPANY

Code 3® SD-24 LED Lights

Small footprint allows for mounting in almost any location on the vehicle while its slim design keeps a low-profile look.

- SAE J595 Class I (Amber, Blue, White & Red) when properly configured
- 24 (1) watt high-intensity LEDs
- 16 flash patterns

Colors: Dimensions without grommet: 3 1/4" W x 1" H x 1/2" D
Dimensions with grommet: 3 3/4" W x 1 1/2" H x 1/2" D

6R1-GR086 \$91.39

L Bracket for SD-24 **6R1-GR091 \$16.29**

Z Bracket for SD-24 **6R1-GR089 \$27.39**



Galls® 6 LED Deck/Grille Light

Galls 6 LED Deck/Grille light is versatile and provides high performance at a low price.

- 6 high performance LED's
- 1.3 amps at 12V
- 10V-30V direct wire
- 6 total flash patterns
- Includes: versatile deck/grille mounting bracket

Colors: 1 1/2" H x 5 1/4" W x 1 3/4" D

6R1-GR017 \$87.29



Six high-performance LEDs deliver additional warning power



LED Single

LED Dual

Rock

Surface Mount

SoundOff Signal



Gen3 LEDs with Versatile Mounting Options

SoundOff Signal Ghost Lights

Mounts almost anywhere, inside or outside. Comes with screws for permanent placement, automotive-grade adhesive for no-holes mounting, and an innovative U-bracket to place on the lip of your vehicle's hood or trunk.

- 6 Gen3 LEDs
- Die-cast housing and moisture and vibration-resistant
- 33 flash patterns

Made in the USA

LED Lights: Adjusts up to 30° angle so you can direct light where you need it.

Colors: Single: 7/8" H x 4" W x 1 1/4" D. Dual: 8" W

Single **6R1-GR278 \$107.59**

Dual **6R1-GR277 \$216.19**

Rock Light: Severe duty design and heavy metal construction.

Colors: 1 1/8" H x 5 1/4" W x 1 3/4" D. 8 oz

6R1-GR338 \$107.59

Surface Mount:

Low profile and versatile Ghost surface mount with nickel-plated chrome housing.

Colors: White, Chrome or Black housing.

1 7/8" H x 5 3/4" W x 1" D

6R1-GR337 \$110.89

Concealable Warning



WHELEN®

Whelen® ION™ Series Super-LED Light

Ion is a super-tough, ultra-compact LED light that is perfect for mounting anywhere on your vehicle, inside or out.

- 48 flash patterns
- Water-resistant designed for the inside or outside of your vehicle
- Includes pedestal/clip mounting bracket for easy installation on trunk lid or grill

Colors: 1"H x 4"W x 2"D

6R1-GR329 \$109.99



WHELEN®

Whelen® ION™ Surface Mount Super-LED

Ion is a super-tough, compact LED light perfect for mounting on any flat surface.

- Super-tough construction resists water, salt chemicals and road vibration
- Single color models have 25 Scan-Lock™ flash patterns; split color model offers 69

Colors: .55"L x 1½"W x 1"D

6R1-GR374 \$160.59

**SoundOff
Signal IIII**

SoundOff Signal Intersector LED

Compact and bright light is designed to mount under the side mirror to provide better intersection warning power to any emergency vehicles.

- 9 extremely bright and powerful Gen3 LED lights
- 180 degree output
- 30 flash patterns
- Waterproof O ring seal
- Includes: wedges and adaptors to custom fit to mirrors or surface

Colors: 2½"H x 3"W x 1½"D

6R1-GR336 \$158.39

Intersector Surface Mount **6R1-GR408 \$166.79**



Decrease the likelihood of emergency vehicle intersection crashes



Easily mounts under side mirrors

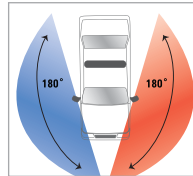

Intense 180 degree output increases officer safety as well as the safety of other motorists



Intersector LED



Intersector Surface Mount

CODE 3®
A PUBLIC SAFETY EQUIPMENT COMPANY

Code 3® XT3 LED Interior/Exterior Light Heads

Available in 2 Head or 4 Head styles, each comes with attached brackets.

- Advanced Gen 3 LEDs and directional optics
- 2 Head has 22 patterns; 4 Head has 31 patterns
- Waterproof for interior or exterior applications

Colors:

2 Head: 1¼"H x 7"W x 1½"D

4 Head: 1¼"H x 14"W x 1¾"D

Desc.	Item	Price
2 Head	6R1-GR275	\$185.49
4 Head	6R1-GR276	\$312.59



2 Head



4 Head

We Accept these Major Credit Cards



Code 3® 6-Pack LED Hide-A-Blast

High performance, low cost and a wide variety of applications.

- 20 flash patterns
- 6 LEDs in polycarbonate clear lens
- 15' cable 12-24 volt direct wire
- Includes: Black Bezel for attractive mounting on any flat surface



Black bezel mounts on any flat surface

Colors: ■, ■, ■, ■, ■, ■, ■. Lighthouse: 5/8" H x 1" D

Flasher box: 3/8" H x 5/8" W x 1 1/8" D

6R1-GR416 \$91.89/ea



SoundOff Signal



SoundOff Signal LED Hide-A-Way

Hide away insert is quick and easy to retrofit existing 1" strobe tube cutouts for headlights, tail or corner lights.

- 30 flash patterns; self-contained flasher board
- Waterproof O-ring seal
- In-line flasher offers 10 ft wire and 4th wire to set optional cruise mode to reduce light output to 20% power

Colors: ■, ■, ■, ■. 1 1/2" H x 1" D

Description	Item	Price
Single Light	6R1-GR340	\$84.99
2 Head Kit	6R1-GR342	\$164.79 SAVE \$5
4 Head Kit	6R1-GR343	\$329.59 SAVE \$10

GALLS

Galls® LED Hide-A-Way

You get all four (4) lenses so you can change lens color whenever you like! LED heads are designed with optics that boost and concentrate light for maximum LED output.

- 10V-24V DW
- Advanced thermal heat management
- Requires 1" mounting hole
- Available as a single light, a 2 head kit, or a 4 head kit
- Comes standard with 30 ft cable for additional installation options

Lamp: 1" H x 1 1/2" D

Description	Item	Price
Single Light	6R1-GR317	\$99.99
2 Head System	6R1-GR318	\$192.59 SAVE \$7.39
4 Head System	6R1-GR319	\$384.99 SAVE \$14.97

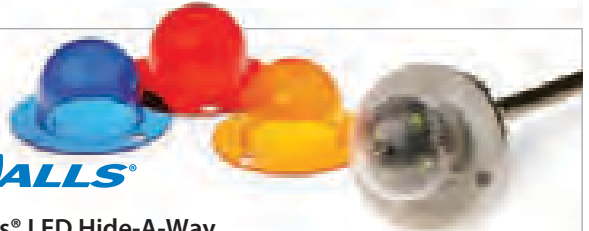

In-line flasher board

WHELEN

Whelen® VERTEX Super-LED Light

Extremely versatile when it comes to mounting options, this self-contained light requires only a one-inch hole in any composite-style headlight, cornering light or taillight assembly.

- SAE Class 5 compliant
- 25 Scan-Lock™ flash patterns with synchronize feature for alternating/synchronous flashing of multiple lamps
- Special lens design fills reflector with warning light
- Available as a single light, a 2 head kit, or a 4 head kit
- 10-16V DC. 9' cable included

Colors: ■, ■, ■, ■, ■, ■, ■. Lamp: 7/8" H x 1 1/2" Dia. Lamp driver: 1/2" H x 7/8" W x 4 3/4" D

Note: LED color must match lens color it is installed behind, except for clear lens

Description	Item	Price
Single Light	6R1-GR282	\$103.99
2 Head System	6R1-GR286	\$200.59 SAVE \$7.39
4 Head System	6R1-GR287	\$389.99 SAVE \$426.98



L Bracket for low-profile mounting

Code 3® 4-LED Low Profile Hide-A-Blast

Ultra-slim, low profile and flush mount design make the units perfect for covert application.

- Meets SAE, California Title 13 requirements in Red, Blue, and Amber when properly configured
- 13 flash patterns and 1 steady, simultaneous or alternating
- Easy to install, 9' cable with y connectors, 80" for light

Colors: ■, ■, ■, ■, ■, ■, ■

Light Head dimensions: 1 1/2" H x 1" D. Controller module: 1" W x 5 1/2" L x 1" H

6R1-GR092 \$192.89/pr

L Bracket for Low Profile Hide-A-Blast **6R1-GR093 \$13.19**



Galls® Large Strobe Light

Long-lasting durability from low profile lighting.

- Non-corroding polycarbonate base
- 22W; 2.5M CP
- 4 flash patterns selected via internal push button control
- 60 lb pull magnet
- 12' coiled cord with a right angle cigar plug

Colors: . 6"H x 6½"D

6R1-RL071 \$113.99



Blue



StarSignal® SVP 201ZL LED Beacon

Powerful lighting with a variety of flash patterns.

- Meets SAE Class III
- Durable ABS plastic base
- 2W STAR Generation - 4 LED
- 29 Customer selectable flash patterns
- .13 amp draw; fully encapsulated circuitry
- 10-16V with cigar plug

Colors: . 3¾"H x 4¾"D

6R1-RL072
Permanent Mount **\$56.49**
Magnetic Mount **\$68.69**



Amber
Magnetic mount



StarSignal® Compact Halogen 9200 Mini Lightbar

Durable rotating 55W halogen bulbs absorb the vibration from large vehicles.

- 2"V" mirrors enhance flash and produce 160 fpm
- Choice of permanent or vacuum formed mag mount
- Permanent mount has 1' cord; magnetic mount has 15' 12V cord with cigar plug

Colors: . For Clear domes, choose up to two colors for rotator filters. 8"H x 18"W x 7"D

6R1-LB435
Permanent Mount (not shown) **\$107.59**
Vacuum-Formed Magnet **\$147.19**



Amber



Code 3® 420 Beacon Halogen Mini Lightbar

Aerodynamic shape coupled with power make this lightbar a heavy hitter.

- SAE Compliant
- 2.55W standard rotators; draws 8.6 amp
- Polycarbonate lens
- 3 different mount options: permanent, magnetic or suction

Colors: . 5¼"H x 16½"W x 8"D

6R1-LB437
Permanent Mounts **\$126.69**
Magnetic Mounts **\$137.29**
Suction Mounts **\$163.89**
Replacement Dome **6R1-LB573R \$39.29**



Red



VISIT US ONLINE

Shop our full selection of warning lights online at:
galls.com/emergency-warning-lights

Galls® Wig-Wag Flashing System

Our basic wig-wag is a popular and extremely affordable way to increase your visibility.

- Solid state flasher; 2 fps
- Alternating flash pattern
- System includes: on/off switch, power indicator light, front-mounted fuse
- Direct wire with 12 ft of fire-resistant wire

Not for use on vehicles with ground side switched headlights.

Visit us online for more information

6R1-FS039 \$37.69



Effective Warning Power

Super Phantom



Split Super Phantom



Split-Phantom Undercover



StarSignal® Super Phantom Interior Lightbar

This bestselling product will let you choose the version that best fits your vehicle and your needs. DL217 is 42" wide, has 30 Gen 4 LEDs that are angled for intersection warning. DL218 is a split version with 24 Gen 4 LEDs and expands from 34-42". Ideal for undercover or unmarked vehicle applications, it mounts in front windshields and straddles the overhead center consoles.

- Long-life, high-intensity Gen 4 LEDs
- 35 flash patterns
- Universal visor clip mount
- 12V DC with 12' cable

Colors:     7/8" H x 34-42" W x 6" D (width varies by vehicle)

\$527.79

Super Phantom **6R1-DL217**
Split Super Phantom **6R1-DL218**



StarSignal® Split-Phantom Undercover Interior Lightbar

This patented unit has a split design made specifically to mount in the front windshield and straddle the overhead console. Yet it can be adapted to mount in almost any location.

- SAE California Title XIII Compliant
- 35 customer selectable flash patterns with push button control
- Angled LEDs for intersection clearing
- No drilling required. Installs in minutes using visor brackets

Colors:     Lightbars measure 7/8" H x 34-42" W x 6" D (width varies by vehicle)

\$543.59

'07-'15 Tahoes, Suburbans and Yukons

'11-'15 Dodge Chargers

'07-'13 Expeditions, '06-'15 Explorers, '04-'15 F-150s, '12-'13

Interceptor SUV

6R1-DL178

6R1-DL179

6R1-DL180



Galls® LED Traffic Arrow

The control switch and mounting kit are included as part of the package.

- 8 LED modules and draws 4 amps
- Integrated "L bracket" control activates 3 warning patterns (left, right and warning flash)
- Mount on rear deck or under lightbar
- Includes: direct wire hook up, 15' cord, sun shield overhang, control switch and mounting kit

Color:  2 1/4" H x 42" W x 1 3/4" D

6R1-DR008 \$298.39

VISIT US ONLINE



Shop our complete selection of lightbars and warning lights online at:
galls.com/emergency-warning-lights

in all Shapes and Sizes



Extremely low profile
— less than 1" high



Split design made to straddle
overhead consoles



StarSignal® Mini Phantom Max LED Plus Deck Lights

The popular Mini Phantom LED Plus Deck Lights just got even better. Same great warning power as the previous model, but now with the addition of a removable shroud, no more flashback.

- Full 3 rows of LEDs for even brighter warning power
- 3 selectable flash patterns with push-button control
- Removable shroud to prevent flashback from reflection
- Direct wire with 12 ft cord; comes in pairs

Colors: 7/8" H x 9" W x 1 3/8" D

6R1-GR308 \$233.79/pr

Shroud alone **6R1-DL208 \$11.79/ea**



Mini Phantom Max



Removable shroud



SoundOff Ultra Lite Directional/Warning LED Light

Uses LED3 Mini Lights to provide brilliant rear warning protection. Offers an optional control head to turn the light into a directional arrow and further direct motorists where to go.

- 15 warning patterns and 20 arrow patterns with optional control head
- Gen 3 LEDs for powerful warning
- Includes: 15' of wiring and mounting bracket
- 5-Year Warranty

Colors: 1 1/2" H x 26" W x 1 3/4" D

Description

Description	Item	Price
Lightbar	6R1-DR007	\$411.69
Lightbar w/ Directional Arrow Control Head	6R1-DR009	\$491.29

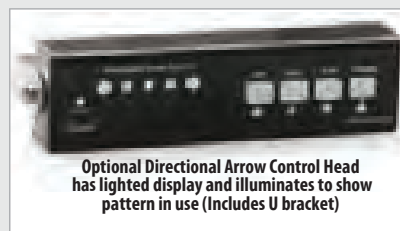

Optional Directional Arrow Control Head has lit display and illuminates to show pattern in use (Includes U bracket)



Galls® LED Mini Bar

This powerful mini lightbar features 19 flash patterns and the added convenience of a 9' power cord with cigar plug end. Compact size is ideal for any vehicle application.

- Meets SAE J845 and California Title 13 specifications
- Polycarbonate lenses and base
- 4 Torus style optic LED lighthoods provide outstanding signal strength and light spread
- Magnetic/suction cup mount; spring loaded magnets allow mini bar to conform to uneven mounting surfaces

Colors: 2 1/8" H x 11" W x 7" D

6R1-LB640 \$213.19



Red

\$213¹⁹

Amber
Magnetic Vacuum Mount



Signal® Mini Bar with M-Tech Plus LEDs

Super bright M-Tech® LED technology and an amazingly low profile make this mini bar a must-have for a wide variety of professions.

- Shock, vibration, and moisture-resistant, injection-molded polycarbonate domes
- 20 selectable flash patterns
- Choose permanent mount or rubber-coated magnet vacuum mount to allow fleet interchangeability and prevent damage to vehicles
- Vacuum magnet mount features 12' cord with pattern selector cigar plug
- Direct wire permanent mount

Colors: 3" H x 16 1/2" W x 8 3/8" D

6R1-LB670

Permanent mount

\$262.49

Magnetic vacuum mount

\$314.99

Red



Flash pattern selector and on/off switches on plug

R1LP



Whelen® Responder LED Mini Lightbars

Responder LPs use high-performance LEDs in a smaller size bar, allowing for many mounting options. Both feature six Super-LED® modules (two on front, two on back and one on each end) to deliver brilliant warning power. The R1LP uses large CON 3™ modules and the R2LP uses Linear 6 LED modules. Both bars offer:

- Class 1, SAE J845 Certified
- Low profile accommodates a variety of applications
- Built-in electronic flasher features 30 Scan-Lock™ patterns
- Rugged polycarbonate base endures the roughest conditions
- Magnetic or permanent mounting option: Magnetic mount includes cigar plug with 8' cord, flash pattern selector and on/off switch on the plug; permanent mount is direct wire

Colors: 2 7/8" H x 17" W x 6 1/4" D

Description	Item	Price
R1LP	6R1-LB461	\$299.99
R2LP	6R1-LB465	\$419.99



R2LP



Federal Signal Highlighter LED Mini Bar

Federal Signal combines long-lasting advanced Solaris® LED technology and Reliable Onboard Circuitry™ to create a lightbar with brilliant 360 degree light distribution and 85% reduction in potential electronic failures.

- SAE J845 Class 1 Compliant
- Compact, low profile design
- Over 20 flash patterns
- Choice of three mounting options: magnetic, suction or permanent
- Includes 10' cord with cigar plug

Colors: 3" H x 15 3/4" W x 8 1/2" D

6R1-LB441 \$382.99



Whelen® Mini JUSTICE Economy LED Lightbar

The Mini JUSTICE is a small yet powerful streamlined lightbar that is easily installed.

- 8 LED heads, 4 corner linear, 6 super LEDs and 4 inboard Con3™ LED modules with optical spreaders
- 95 flash patterns to give you multiple options
- Magnetic mount and a DC plug with flash pattern and on/off switch on the plug; Permanent Mounting Kit sold separately

Colors: 2 1/4" H x 22" W x 12" D

6R1-LB483 \$674.99

Permanent Mounting Kit 6R1-LB455 \$92.99

Respond Quickly and Safely with Full-Power Lightbars



WHELEN

Whelen® Justice LED Lightbars

Bestseller! Powerful Gen 3.5 Linear 6 LED corner modules are combined with more economical Gen 3.5 Conical 3 modules with optical spreaders.

- SAE Class 1 Compliant
- 52 patterns with Scan-Lock™ or 3 maximized patterns with LB479
- Low power option can reduce light heads by about 20%
- Center aluminum frame for support
- LR 11 LED adjustable takedown lights and alley lights (a pair of each)

Colors: ■■■, ■■■, ■■■, ■■■, ■■■, ■■■. 2¼"H x 50–56"W x 12"D. Due to the size and weight of full-size lightbars, please add \$24.99 shipping costs to each lightbar ordered

Description	Item	Price
16 Head 50"W Economy	6R1-LB470B	\$1399.89
16 Head 56"W Economy	6R1-LB470B	\$1503.89
10 Head with Traffic Advisor 50"W Economy	6R1-LB471B	\$1909.49
16 Head 50"W Competitor Plus	6R1-LB479B	\$1768.69
Hook-On Mounting Adapters	6R1-LB063	\$58.29

Shop our selection of traffic safety products starting on p. 208



CODE 3
A PUBLIC SAFETY EQUIPMENT COMPANY

Code 3® 2100 21TR Lightbars

The 2100 21TR with Torus LED technology provide the intensity and features you're looking for with superior directional and off-angle performance.

- Meets SAE when properly configured
- 16 Head LED Lightbar Deluxe central controller
- 23 flash pattern selections, Narrowstik Function and corner cruise
- 12 Head Halogen Lightbar has basic central controller with 12 flash pattern selections
- Takedown and alley lights

Colors: ■■■, ■■■, ■■■, ■■■, ■■■, ■■■. 2½"H x 47"W x 12¼"D. Due to the size and weight of full-size lightbars, please add \$24.99 shipping costs to each lightbar ordered

Description	Item	Price
12 Head	6R1-LB587	\$1449.49
16 Head	6R1-LB588	\$1794.59
Mounting Adapter Kit	6R1-LB057	\$27.29

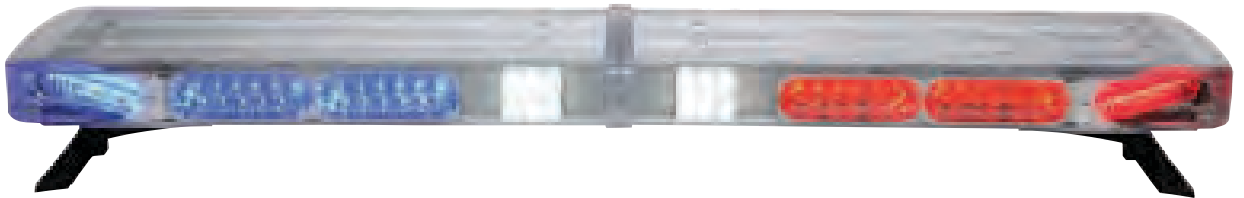

WHELEN

Whelen® Liberty™ II Series LED Lightbar

Whelen's Liberty II combines advanced design with proven Whelen engineering, for maximum output and reliable operation.

- SAE Class I, California Title XIII
- 14 Solo Series LED light heads with super LED alley and takedown lights
- 12 flash patterns and 4 traffic advisor patterns
- Whelen's exclusive Collimator™ patented design captures, collects and focuses light
- Advanced Thermal Design (ATD) reduces the stress on LEDs when dwell time is extended
- Aluminum top shield protects the lightbar from the elements and directs heat away from internal components
- Center divider with LIM (Liquid Injection Molded) wiper seals assure lightbar integrity in all conditions
- Hard-coated lenses minimize damage from the sun, salt and road chemicals

- The I/O board snaps into brackets
- Point to point wiring between the I/O board and each light head creates a clean look and allows for easy reconfiguration
- 48" model has one piece UNI-DOME construction with a single sealing point
- Hook-On Mounting adapter available (LB063)

Colors available: ■■■, ■■■, ■■■, ■■■. 2½" x 11¼" x 48" or 2¼" x 11¼" x 54". Due to the size and weight of full-size lightbars, please add \$24.99 shipping costs to each lightbar ordered

6R1-LB193B	\$2273.99
Hook-On Mounting Adapter	6R1-LB063 \$58.29

Ordering online? Use your **PROMOTIONAL CODE** from the back cover

800.477.7766 • galls.com

275

Maximize Your Budget with Combo Kits



Galls® Siren and Concealment Speaker Kit

Get your high quality, feature-loaded siren equipment in one of these budget-friendly combinations. Everything you need for effective audible warning, at a price that can't be beat. Featuring our bestselling Concealment Speaker and Deluxe Siren.

Speaker measures 5 $\frac{7}{8}$ "H x 5 $\frac{7}{8}$ "W x 3 $\frac{1}{4}$ "D. Siren measures 2"H x 5 $\frac{3}{4}$ "W x 6 $\frac{1}{4}$ "D

- Galls Concealment Speaker (SK166) offers concealable 100W power with the light weight and reliability of a neodymium drive
- Galls Deluxe Full Feature Siren (SK125) features advanced technology such as comprehensive speaker diagnostics to ensure efficient, long-lasting service

6R1-SK147 \$370.59 SAVE \$30.89
\$401.48 if purchased separately

Concealment Speaker **6R1-SK166 \$159.99**
 Deluxe Full Feature Siren **6R1-SK125 \$245.19**



Deluxe Siren/Speaker Kit



Galls® Remote Siren/Speaker Combo

Best-selling Galls Concealment Speaker and Remote Siren Kit.

- Galls Concealment Speaker (SK166)
- Galls Street Thunder 100W Remote Siren with 2 light control (SK195)

6R1-SK205 \$366.49

Concealment Speaker
6R1-SK166 \$159.99
 100W Remote Siren with light control
6R1-SK195 \$229.19



Galls® Economy Speaker/Siren Kits

A great option for tight budgets, these kits provide the reliable equipment you need at a price you can afford. Perfect as a low-cost starter kit or an affordable replacement for your old system.

Speaker/Siren Kit:

- Galls 100W Speaker (SK144) features a lightweight Neodymium driver to deliver a lot of volume for a small investment, this traditional-style speaker puts out some serious sound
- Galls Full Feature Siren (SK124) has been pgraded to meet even more of your needs, this siren now includes mounting brackets, replaceable jumpers for option selection and automatic short circuit protection against speaker shorts

6R1-SK143 \$289.99

SAVE \$40.79
\$330.78 if purchased separately

100W Speaker **6R1-SK144 \$146.99**
 Full Feature Siren **6R1-SK124 \$183.59**



Speaker/Siren Kit

Covert, Compact Remote Sirens



Galls® Street Thunder 100W Remote Siren

Handheld Galls Street Thunder Remote (available with or without light control feature) is an unbelievable price.

- Operates on 100W output
- Two outputs with 4 functionality options: 8 second timer, momentary, normal closed or standard on/off
- Hands-free three-tone cycle
- Programmable air horn (locks out siren tones)
- Over/under voltage and speaker short protection
- 49 legend titles
- Buttons back lit by green off/red on LED's
- Includes: amplifier box, control head and VELCRO® brand for optional dash mounting

Control head: 4½"H x 2"W x 1½"D. Remote amplifier: 2¾"H x 11"W x 7½"D

Description	Item	Price
ST180 without light control	6R1-SK194	\$211.89
ST182 with light control	6R1-SK195	\$229.19



StarSignal® LCS880 Handheld Remote Siren

This handheld remote siren controls both your siren and your lights.

- Meets Class A requirements
- Drives one or two 100W speakers
- Tones: Air-Horn, Manual, Phaser, Two-Tone, Wail, Yelp
- Horn ring transfer
- Integrated PA mic
- 7 light functions
- Park kill
- Red and green backlighting
- Auxiliary input
- 4 position slide switches with LED indicators
- Includes: wiring harness, locking connector, hand-piece cradle and VELCRO® brand

Handheld control: 6"H x 2½"W x 1½"D. Remote amp: 2½"H x 7"W x 7¾"D. Flange on each side: ¾"

6R1-SK127 \$409.99



Whelen® Handheld Siren/Light Controller

Compact, handheld remote lets you control your sirens and lights, with the added advantage of a built-in microphone.

- Meets Class A requirements
- Operates one or two 100W speakers
- Horn ring for hands-free control
- Tones: Air-Horn, Manual, Piercer, Wail, Yelp
- 12 illuminated remote buttons including a three-position button in place of a slide switch
- Park kill
- Green backlighting on buttons, switches turn red when activated
- Includes: 20 ft interconnecting cable, user selectable switch labels

Handheld remote: 5½"H x 2¼"W x 1½"D. Amp/Relay Module: 2½"H x 8"W x 7"D

6R1-SK157 \$419.99



Galls® Street Commander ST300

Combines a full-feature siren and an eight-function light control panel into one keypad.

- Meets Class A requirements
- Drives one or two 100W speakers
- Tones: Air-Horn, Manual, Phaser, Two-Tone, Wail, Yelp
- Horn ring transfer
- 4 position slide switches with LED indicators
- Integrated noise cancelling PA microphone
- Protected against speaker shorts with self-resetting circuit and high-and-low voltage shutdown protection
- Includes: wire harness with positive locking connector, mic clip mounting bracket, hardware and 30 standard label functions

Control head: 3¾"H x 6¾"W x ¾"D. Amplifier: 2½"H x 7"W x 7¾"D

6R1-SK156 \$468.99





Rotary knob
and improved diagnostics
on Full Feature Siren



Galls® Street Thunder™ Sirens

Choose from these bestsellers, for powerful, reliable sound.

- Meets Class A requirements
- Automatic short circuit protection for speaker shorts
- Tones: Air-Horn, Manual, Thunder, Two-Tone, Wail, Yelp
- High/Low voltage shutdown

Basic Siren and control unit of the Remote Siren:
2"H x 6"W x 5¾"D.
Full Feature Siren: 2½"H x 6"W x 6½"D



Description	Item	Price
ST105 Basic	6R1-SK122	\$127.89
ST110 Remote	6R1-SK123	\$136.49
ST160 Full Feature	6R1-SK124	\$186.59

Traditional Sirens



Galls® Street Thunder™ Deluxe ST240 Full Feature Siren

The Galls Deluxe Full Feature Siren features advanced technology such as comprehensive speaker diagnostics to ensure efficient, long-lasting service.

- Meets Class A sound requirements
- Sturdy aluminum construction
- Drives one or two 100W speakers (200W max)
- Tones: Wail, Yelp Air Horn, Thunder, Manual and Two-Tone sounds
- PA Override; Park kill; Rotary knob selection; Speaker diagnostics
- Automatic short circuit protection against speaker shorts; Auxiliary input; Positive and negative switching for input; High/Low voltage shutdown protection
- Includes: replaceable jumpers for option selection and automatic short circuit protection

2"H x 5¾"W x 6¼"D

6R1-SK125 \$245.19



Whelen® Epsilon Series Electronic Siren

For a very economical price you get a quality Whelen siren that has a surprising number of features including nine Scan-Lock™ tones and even a real time diagnostic indicator.

- Meets Class A requirements
- Tones: Air-Horn, Hi/Low, Piercer, Wail, Yelp, Y249, manual wail coast to stop, manual wail stop and tone off
- PA volume control; rotary switch

2¼"H x 5⅞"W. 5¾"D

6R1-SK176 \$196.19

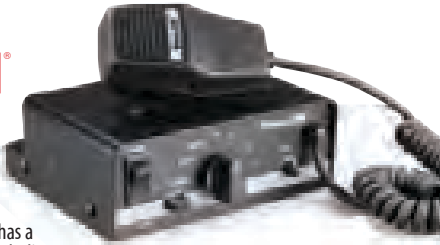

Whelen® Diagnostic-Enabled Siren with Scan-Lock™ Tones

Diagnostic feature lets you know if the system is working as it should.

- Meets Class A requirements
- Scan-Lock™ lets you customize the rotary knob for the tones you want
- Operates up to two 100 watt speakers
- Adjustable bail bracket allows siren to be mounted in a variety of positions
- Park kill override
- Horn ring operation so you can keep hands on the wheel

2¾"H x 6½"W x 6½"D. Wiring not included

6R1-SK158 \$288.89



Whelen® Electronic Siren with Scan-Lock™ Siren Tones

Scan-Lock™ Siren Tones allow for user-selectable siren tones via momentary recessed switch

- Meets Class A requirements
- Comes with Wail, Yelp and Piercer™
- Adjustable bail bracket allows the mounting of siren in a variety of positions
- Hands-free operation, access power and siren tones without taking hands from the wheel

2½"H x 6"W x 5½"D. Wiring not included

6R1-SK155 \$237.29



Federal Signal PA300 Siren

Tap II horn-ring transfer allows warning without removing hands from wheel.

- Meets Class A sound level output requirements when paired with Federal Signal High-Power Speaker
- Drives one or two 100W speakers
- Tones: Air-Horn, Hi-Lo, Manual, Wail, Yelp
- Siren override provides instant PA use
- Includes wiring harness and bracket

2¾"H x 6⅞"W x 7⅞"D

6R1-SK023 \$316.69





Galls® Street Thunder™ Deluxe ST280 Siren with Light Controls

Galls Deluxe Siren with Light Controls provides selection for both lighting and siren together in one unit. Rotary knob selection and four backlit switches with replaceable labels make selections easier.

- Meets Class A sound requirements
- Sturdy aluminum construction
- Drives one or two 100W speakers (200W max)
- Tones: Wail, Yelp Air Horn, Thunder, Manual, Two-Tone
- Four-position slide switch with seven-function light control switch panel; Easy-to-use selector knob
- LED backlighting
- High/Low voltage shutdown protection
- Automatic short circuit protection against speaker shorts
- Positive and negative switching for AUX and PKILL inputs
- Includes speaker diagnostics

3"H x 6"W x 6½"D

6R1-SK126 \$314.69

Full-Function Sirens



Code 3® XCEL Siren

Simple to operate while driving, the three-level slide switch can be programmed as independent, semi-progressive, or progressive, giving you more options.

- SAE J1849, 2004/104/EC and California Title 13 compliant
- Oversized manual wail and air horn buttons
- 6 programmable auxiliary buttons

2¾"H x 6½"W x 5½"D. 3.5 lbs. Visit galls.com for more details

6R1-SK243 \$344.99



The only siren amplifier system with dual tone capability, low frequency, electronic air horn, plus additional built-in specialty tones all in one box.



Code 3® Banshee Low Frequency Siren

Delivers phenomenal audio impact, especially at intersections and while traveling through high ambient noise conditions.

- Meets SAE J1849 and CA Title 13 when properly configured
- Dual tone capability, low frequency, electronic air horn, plus built-in specialty tones
- Works with one set of standard size speakers (Code 3 speakers are recommended)

2¾"H x 8½"W x 5¾"D. 3.2 lbs. Visit us online for more details

6R1-SK242 \$253.79



Code 3® V-Con® Full-Function Siren

This small full-function siren features radio rebroadcast and PA, built-in relays and back lighting for good visibility. Model # 3692 L4.

- Meets Class A requirements
- Drives one or two 100W speakers
- Tones: Air-Horn, Hyper-Yelp, Wail, Yelp
- Three-position progressive slide switch plus 4 auxiliary switches

2¼"H x 5½"W x 6½"D. Wiring not included

6R1-SK113 \$414.19



Code 3® MasterCom™ Siren

When you're in pursuit, you can't afford to fumble around with your controls. That's when you need the Code 3® MasterCom™.

- Meets all Class A sound level output requirements
- 100 and 200-watt capability
- Tones: Wail, yelp, hyper-yelp, hi-lo and hyper-lo

2¾"H x 6¾"W x 7"D

6R1-SK053 \$469.79

VISIT US ONLINE

Shop our complete assortment of sirens online at: galls.com/sirens

Ordering online? Use your **PROMOTIONAL CODE** from the back cover

800.477.7766 • galls.com

279

Efficient Control at Your Fingertips



NEW

Star Signal® Switch Panels

Control your lightbar and other warning lights of your choosing. Illuminated switches and backlit legends for night patrol shifts or low-light surroundings.

- All switches are illuminated
- Legends are backlit for easy night usage
- Includes legends, mounting brackets, hardware and instructions

SB4020 Six Function Switch Panel: 40 amp switch, (5) 20 amp switches, 2' wire harness. 2"H x 6"W x 4¾"D

6R1-SE026 \$10.49

SB4040 Switch Panel with Slide Switch: includes 4) 20 amp switch, (1) 3 mode 40 amps max, progressive slide switch, 2' wire harness, customer adjustable jumper (1 & 2 work independently). 2¼"H x 6½"W x 5¼"D

6R1-SE027 \$141.99



LOWER PRICES



Galls® Switch Panels

These switch panels are designed for use with lower amp LEDs and offers complete control of your LED system from one control panel.

- 5 switches fused at 10 amps and 1 switch fused at 20 amps
- 6 blank legend plates and kit of 60 adhesive backed tiles

Six-Function: 2"H x 5"W x 4¾"D

6R1-SE103 WAS \$52.49 NOW \$39.37

Nine-Function: 20-amp, three-position slide switch that allows you to turn off groups of lights in a sequential mode. 2"H x 5"W x 4¾"D

6R1-SE104 WAS \$74.89 NOW \$56.17



Galls® SAE-Approved Nine-Function Switch Panel

The durable components of the Galls® Nine-Function Switch provide superior durability and performance. Electronics are protected by heavy-duty components. This switch even includes a 40-amp, three-position slide switch that allows you to turn off groups of lights in a sequential mode.

- SAE-approved grade wiring
- 6 switches fused at 20 amps
- 40-amp, three-position slide switch
- U-shaped bracket for easy mounting
- 6 blank legend plates and a kit of 60 adhesive-backed titles

Satin/wrinkle and black powder-coat finish. 2"H x 6¼"W x 4¾"D

6R1-SE082 \$115.49

Maximum Volume, Maximum Warning



Galls® 100W Speaker

A lot of volume for a small investment, this traditional-style speaker puts out serious sound. It also features a neodymium driver that makes it lighter in weight and more reliable.

- Meets Class A requirements
- Polycarbonate, metal construction
- 100W driver/projector combo generates 120dB of sound at 10'
- Designed for mounting behind the grille or on the bumper

5½"H x 8"W x 5½"D

6R1-SK144 \$146.99



Federal Signal® AS124 100W Speaker

The Federal Signal® 100W Speaker is a compact unit that offers great flexibility for installation.

- Meets Class A requirements
- Rugged nylon composite housing
- 100W
- Includes mounting bolts and hardware kit

5¾"H x 4¾"W x 7¾"D

6R1-SK092 \$161.59

Speaker Mount for Crown Vics **6R1-SK148 \$39.99**



Galls® Concealment Speaker

Amazing sound for such a compact speaker. The high performance neodymium driver gives it a dynamic sound, plus lighter weight and greater reliability!

- Meets all Class A sound level output requirements
- Corrosion-resistant metal finish
- 100W
- Field replaceable driver
- Installs easily; comes with a universal fit bracket that adapts to most vehicles

5⅞"H x 5⅞"W x 3¼"D

6R1-SK166 \$159.99



Signal™ D-44 Cyclone 100W Speaker

Patent-pending Cyclonic Expansion chambers offer speaker technology for big sound in a size compact enough to fit easily into a car! By increasing the length of the passageway, the coil design increases the sound resonance.

- Exceeds Acoustical requirements: SAE J1859 Title 13 Class A
- Rust-free and rugged glass-filled nylon housing
- 100W
- Universal brackets included

6½"H x 6½"W x 3"D

6R1-SK178 \$163.69



Whelen® Compact Speaker

Whelen delivers excellent quality, and you can install in the radiator cross member in minutes.

- Meets Class A sound level requirements
- Black nylon-composite housing
- 100W
- Bracket included

6½"H x 6½"W x 3"D. Specify year, make and model of vehicle

6R1-SK162 \$201.69



Federal Signal® Dynamax ES100 Speaker

Dynamax speaker uses the Federal Signal Neo Driver, which has a proven track record performance of reliability.

- Meets SAE J1849, Title 13 and Class A requirements
- Black corrosion-resistant aluminum housing
- 100W
- Comes with a universal fit bracket. Vehicle-specific bracket, sold separately below

5½"H x 6"W x 2¾"D

6R1-SK179 \$226.89

Vehicle-specific mount bracket

6R1-SK180 \$32.49

Best Value Nylon Gear



LawPro®

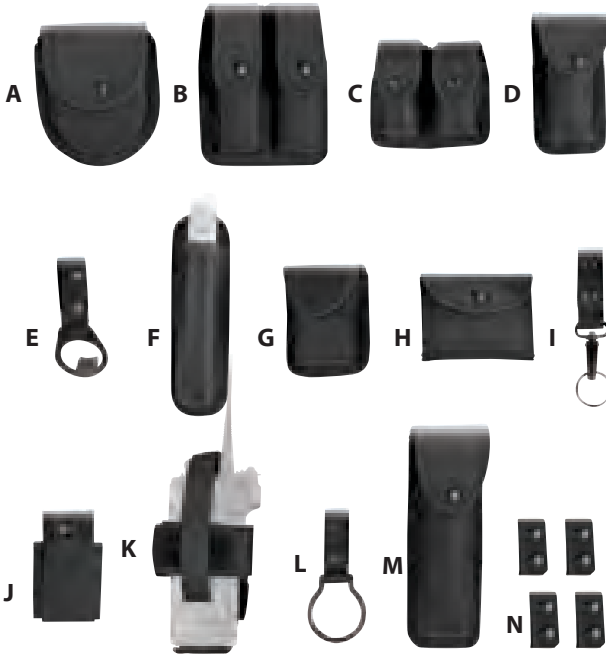

LawPro® Molded Nylon Duty Gear

A) Handcuff Case	6R1-NP055	\$14.99
B) Double Magazine Pouch (Dual Carry Option)	6R1-NP014	\$17.49+
C) Double Speedloader Case	6R1-NP039	\$18.89
D) OC/Mace Pouch	6R1-NY063	\$11.79
E) Baton Holder	6R1-NY068	\$8.59
F) Expandable Baton Holder	6R1-NP060	\$11.79
G) Pager/Emergency Glove Pouch	6R1-NP041	\$11.99
H) Double Emergency Glove Pouch	6R1-NP036	\$11.79
I) Standard Key Ring Holder	6R1-NP057	\$8.59
J) Silent Key Ring Holder	6R1-NP047	\$11.79
K) Universal Radio Holder	6R1-NP058	\$19.19
L) Flashlight Holder	6R1-FL005	\$8.59
M) Mini Flashlight Holder	6R1-FL003	\$11.79
N) ¾"W Belt Keepers	6R1-NP027	\$8.59/4 pk



LawPro®

LawPro® Molded Nylon Duty Belt

Lightweight, high-quality ballistic nylon construction ensures that your gear is secure but easy to remove.

- 2"W belt
- Molded foam interior
- Adjustable VELCRO® brand
- Dual-Release Buckle locks up secure; made of durable plastic

Sizes: S (26-30), M (32-36), L (38-42), XL (44-48), 2X (50-54), 3X (56-58), 4X (60-62), 5X (64-66), 6X (68-70)

6R1-NP022 starting at \$18.19+

LawPro® Tri-Release Replacement Buckle **6R1-UA012 \$3.99**

LawPro® Nylon Inner Duty Belt

- 1½"W belt
- Adjustable hook-and-loop closure

Sizes: S (26-30), M (32-36), L (38-42), XL (44-48), 2X (50-54), 3X (56-58), 4X (60-62), 5X (64-66), 6X (68-70)

6R1-NP020 \$11.99

\$66³⁹

LawPro®

LawPro® 10-Piece Nylon Duty Gear Rig

The nylon gear you need in one value-priced package.

- 2"W nylon duty belt
- Includes: single handcuff case, silent key ring holder, 4-pack of ¾"W belt keepers, universal radio holder, emergency glove pouch (holds 2 pair), mini flashlight holder

Sizes: S (26-30), M (32-36), L (38-42), XL (44-48), 2X (50-54), 3X (56-58), 4X (60-62), 5X (64-66), 6X (68-70)

6R1-LP120 starting at \$66.39 SAVE \$30.19

See our extensive selection of handcuffs and transport restraints, starting on p. 318

+ Visit us online for pricing on additional options.

for Everyday Reliability

Accessories
Starting at
\$859

DutyPro™



DutyPro™ Nylon Duty Gear

A) Handcuff Case	6R1-NP252	\$12.79
B) Double Cuff Case	6R1-NP480	\$19.19
C) Double Mag Pouch	6R1-NP275	\$16.99
D) Speedloader Pouch	6R1-NP481	\$19.19
E) MKIII Mace® Holder	6R1-NP249	\$14.99
F) MKIV Mace® Holder	6R1-NP250	\$14.99
G) 21" Expandable Baton Holder	6R1-NP320	\$15.29
H) 26" Expandable Baton Holder	6R1-NP321	\$15.29
I) Glove Case	6R1-NP319	\$11.79
J) Key Strap	6R1-NP254	\$8.59
K) Silent Key Holder	6R1-NP323	\$14.99
L) Universal Radio Holder	6R1-NP322	\$19.19
M) Double Ring Flashlight/Baton Holder	6R1-NP302	\$12.79
N) AA Mini Light Holder	6R1-NP248	\$8.59
O) Belt Keepers	6R1-NP318	\$8.59/4 pk



Trouser Belt

Sam Browne Belt

DutyPro™ Trouser Belt

Equipped with internal stiffener for support and to withstand everyday abuse. VELCRO® brand closure and inner lining for easy adjustability.
1½"W. Sizes: S (28-32), M (34-38), L (40-44), XL (46-50) and 2X (52-56)

6R1-NP313 \$11.79

DutyPro™ Sam Browne Belt

Sam Browne Belt provides the firm platform you need to store all of your gear. VELCRO® brand interior allows you to adjust belt.

2"W. Sizes: S (28-32), M (34-38), L (40-44), XL (46-50) and 2X (52-56)

6R1-NP251 \$19.99

DutyPro™ Belts and Accessories

Sturdy DutyPro accessories and belts are made to stand up to everyday wear and tear. Constructed from a lightweight and easy-to-clean nylon with a durable platform to store all of your gear.

Long-Lasting Professional Appearance



Liner Belt

Duty Belt

BIANCHI® PatrolTek™ Liner Belt

Value-priced comfort for all-day wear.

- Combines with duty belt to create a keeperless belt system
- Tough web construction with hook-and-loop closure
- 1½" wide

Sizes: XS (24-28), S (28-34), M (34-40), L (40-46), XL (46-52), 2X (52-56)

6R1-NP826 \$15.99

BIANCHI® PatrolTek™ Duty Belt

Secure gear with tri-release buckle protection.

- Tough, multi-layered web construction provides durability and performance
- Tri-release buckle reduces the chance of accidental buckle release
- Loop lined for use with liner belt
- 2" wide

Sizes: XS (24-28), S (28-34), M (34-40), L (40-46), XL (46-52), 2X (52-56)

6R1-NP940 \$22.39



5 Star Gear Duty Rig in a Box

Engineered from the contemporary applications of ballistic nylon, this rig is as rugged as it is practical. A hassle-free system, Rig in a Box incorporates specifically designed pouches with optional belt keepers to secure your gear throughout the duration of your shift. For a fast, easy, cost-effective work belt, this Duty Rig deserves a five-star rating.

- Includes: duty belt, silent key holder, baton pouch, single handcuff case, flashlight holder, mace pouch, glove pouch and 4 belt keepers
- Baton pouch fits 21" models; pepper spray case fits MK3 size
- Flashlight pouch fits up to 8½" lights; radio pouch dimensions: 4.5"x3"x1.5"

6R1-NY662 \$81.19

PatrolTek™



BIANCHI® PatrolTek™ Duty Gear

A) Single Handcuff Case with Key Slot	6R1-NP828	\$16.99
B) Covered Handcuff Case	6R1-ZY327	\$19.29
C) Double Magazine Pouch	6R1-NP831	\$22.49
D) Small OC/Mace® Spray Pouch	6R1-NP071	\$12.19
E) Large OC/Mace® Spray Pouch	6R1-NP818	\$15.79
F) Open Top OC/Mace Holder	6R1-NP098	\$13.19
G) Expandable Baton Holder	6R1-NP927	\$14.19
H) Double Emergency Glove Pouch	6R1-NP937	\$13.29
I) Silent Key Ring Holder	6R1-NP938	\$10.89
J) Swivel Radio Holder	6R1-NP912	\$26.99
K) Cell Phone Pouch	6R1-ZA2616	\$19.69
L) D-Cell Flashlight Ring	6R1-NP939	\$7.49
M) Streamlight Holder for Stinger/XT	6R1-ZW276	\$8.79
N) Compact Flashlight Pouch	6R1-NP895	\$14.49
O) Holder for SureFire 6P	6R1-NY121	\$8.99
P) 2" Wide Belt Keepers	6R1-NP934	\$10.19/4 pk

BIANCHI® PatrolTek™

Lightweight and weatherproof, Bianchi® PatrolTek™ skimps on only one thing in duty gear — the price! This value line features all of the "bells and whistles" that typically cost much more.

and Value-Priced Comfort for All-Day Wear

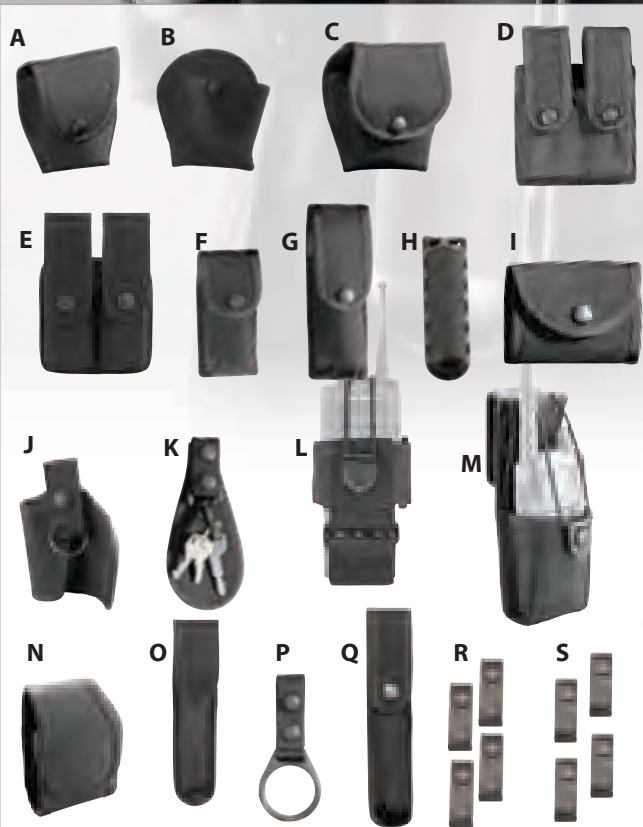

Uncle Mike's® Duty Belt Accessories

A) Single Cuff Case	6R1-NP045	\$25.99
B) Open Top Cuff Case	6R1-NP315	\$25.99
C) Double Cuff Case	6R1-NP065	\$31.99
D) Double Magazine Case/Staggered	6R1-NP033	\$30.99
E) Divided Magazine Case	6R1-NP307	\$37.99
F) Mark 3 Defense Spray Case	6R1-NP088	\$20.99
G) Mark 4 Defense Spray Case	6R1-NP044	\$24.99
H) Molded Expandable Baton Holder*	6R1-NP432	\$18.99
I) Double Latex Glove Carrier	6R1-NP126	\$20.99
J) Silent Key Holder	6R1-NP064	\$18.99
K) Key Ring Holder with Flap	6R1-NP040	\$17.99
L) Universal Radio Case with Swivel	6R1-RC034	\$50.99
M) Radio Case	6R1-NP547	\$45.99
N) MD Pager Case	6R1-NP546	\$21.99
O) Mini Flashlight Holder	6R1-NP043	\$18.99
P) D-Cell Flashlight Holder	6R1-NP028	\$12.99
Q) Stinger® Flashlight Holder	6R1-NP155	\$21.99
R) Molded Belt Keepers	6R1-NP042	\$18.99/4 pk
S) Nylon Web Belt Keepers	6R1-NP119	\$17.99/4 pk

*Holds 21" expandable baton. Slot in back allows fast reholstering of open baton.



Uncle Mike's® Buckleless Trousers Belt

Durable Kodra® nylon web construction means this belt can withstand the daily rigors of your job.

- VELCRO® brand length adjustment
- Duty belt can be worn over it

1½"W. Sizes: M (32-36), L (38-42) and XL (44-48)

6R1-NP031 \$12.49

Uncle Mike's® Ultra Nylon Duty Belt

Made of four layers of tough 2" nylon webbing for added durability and easy care.

- Triple-retention buckle reduces the possibility of accidental opening
- Four-layer laminate construction for rigidity and comfort
- Wear resistant and abrasion resistant
- Precision-stitched edging

2"W. Sizes: M (32-36), L (38-42) and XL (44-48)

6R1-NP118 \$27.79

Uncle Mike's Two-layer Nylon Duty Belt (not shown) **6R1-NP030 \$21.89**

Uncle Mike's Duty Gear and Accessories

Committed to providing you with quality products that are designed with officer safety, operation and performance in mind. Uncle Mike's combines the classic look of leather with the convenience and long-lasting durability of nylon. Multi-layer laminates with Kodra® nylon construction will withstand the daily wear of your job.

Duty Rigs to Support



Trouser Belt

Duty Belt

Galls® Trouser Belt

Internal stiffener adds the strength and rigidity needed.

- Reversible
- VELCRO® brand lining and closure
- Interlocks with duty belt for added stability

1½"W. Sizes: S (28-32), M (34-38), L (40-44), XL (46-50) and 2X (52-56)

6R1-NP240 \$16.99

Galls® Duty Belt

Belt is designed to give superior adhesion to underbelt for maximum stability for those on the move.

- VELCRO® brand lining
- Tri-release buckle

2¼"W. Sizes: S (28-32), M (34-38), L (40-44), XL (46-50) and 2X (52-56)

6R1-NP238 \$28.99

Galls® Molded Nylon Duty Rig

All the essential duty gear you need in one convenient, affordable kit.

6E1-NP467 \$162.39

Rig Contents

- | | |
|---|-------------------------------------|
| 1 Sam Browne Duty Belt (NP238) | 1 Double Magazine Pouch (NP242) |
| 1 Trouser Belt (NP240) | 1 AA Mini Light Holder (NP245) |
| 1 Silent Key Holder (NP053) | 1 Universal Radio Holder (NP246) |
| 4 4 Nylon Belt Keepers (NP091) | 1 Glove Pouch (NP247) |
| 1 Double Ring Flashlight Holder (NP190) | 1 Pepper Spray Holder (NP243/NP244) |
| 1 Hand Handcuff Case (NP241) | 1 Baton Holder (NP008/NP009) |



Galls Molded Nylon
Duty Belt
Accessories
Starting at
\$12⁹⁹

Galls® Molded Duty Belt Accessories

- | | | |
|-------------------------------------|------------------|---------------------|
| A) Handcuff Case | 6R1-NP241 | \$17.29 |
| B) Double Handcuff Case | 6R1-NP477 | \$21.39 |
| C) Double Staggered Mag Pouch | 6R1-NP242 | \$26.39 |
| D) Double Speedloader Pouch | 6R1-NP479 | \$21.39 |
| E) MK III Mace® Holder | 6R1-NP243 | \$19.29 |
| F) MK IV Mace® Holder | 6R1-NP244 | \$19.29 |
| G) 21" Expandable Baton Holder | 6R1-NP008 | \$18.29 |
| H) 26" Expandable Baton Holder | 6R1-NP009 | \$18.29 |
| I) Glove Pouch | 6R1-NP247 | \$21.39 |
| J) Silent Key Holder | 6R1-NP053 | \$13.19 |
| K) Universal Radio Holder w/ Swivel | 6R1-NP246 | \$30.49 |
| L) Double Ring Flashlight Holder | 6R1-NP190 | \$14.19 |
| M) AA Mini Light Holder | 6R1-NP245 | \$15.29 |
| N) Belt Keepers | 6R1-NP091 | \$13.19/4 pk |

Galls® Molded Nylon

When you choose our molded nylon duty gear, you are guaranteed a long-lasting professional appearance at a price that's so affordable, you almost won't believe it! Constructed of the finest ballistic nylon with closed-cell foam trilaminate, Galls Molded Nylon compares favorably and, in some cases, performs better than that of major name brands. Enjoy the dependability of duty gear that is fade and scratch resistant, combined with the convenience of being weatherproof and hand washable.

the Tough Demands of Your Job



BIANCHI

AccuMOLD

Bianchi® AccuMold® Duty Belt Accessories

A) Open Cuff Case	6R1-NP365	\$22.99
B) Single Cuff Case	6R1-NP166	\$19.99
C) Double Cuff Case	6R1-NP167	\$27.99
D) Single Mag Pouch	6R1-NP385	\$20.39
E) Closed Top Double Magazine Pouch	6R1-NP164	\$29.99
F) Open Top Triple Threat™ II Mag Pouch	6R1-NP291	\$25.99
G) Double Speedloader Case	6R1-NP165	\$31.69
H) Mark III Spray Case	6R1-NP169	\$18.99
I) Mark IV Spray Case	6R1-NP170	\$18.99
J) 16" or 21" Expandable Baton Holder*	6R1-NP580	\$15.99
K) 26" Expandable Baton Holder (not shown)	6R1-NP581	\$17.19
L) PR-24® Holder	6R1-NP175	\$8.59
M) Pager/Glove Case	6R1-NP177	\$20.79
N) Silent Key Holder	6R1-NP171	\$18.99
O) Universal Radio Case with Swivel (7½"H x 2¾"W x 1½"D)	6R1-RC031	\$31.99
P) Adjustable Radio Holder	6R1-NP453	\$38.99
Q) Mini Light Holder	6R1-NP172	\$17.19
R) D-Cell Flashlight Ring	6R1-NP174	\$8.39
R) Belt Keepers	6R1-NP168	\$10.99/4 pk

*Specify 16" or 21".



Bianchi® AccuMold® Nylon Liner Belt

Lightweight, yet tough enough to provide the added support for your duty rig. Sturdy web construction for a reliable inner nylon belt.

- Fits up to 2¼"W duty belts
- Hook-and-loop closure

1½"W. Sizes: S (28-34), M (34-40), L (40-46), XL (46-52)

6R1-NP161 \$25.79

Bianchi® AccuMold® Duty Belt

Supplies the long-lasting support and durability you need. Combines closed-cell foam construction and an internal stiffener.

- Molded CopLok™ polymer buckle
- Lined with loop material to secure trouser belt
- Five-part laminate construction
- Belts are oversized to accommodate liner belt and padding

2¼"W. Black. Sizes: S (28-34), M (34-40), L (40-46), XL (46-52)

6R1-NP160 \$44.99

Bianchi® AccuMold®

Ballistic weave-molded fabric with closed-cell foam trilaminate construction provides support and durability. AccuMold is weatherproof and washable.

Nylon Duty Gear That Increases Stability



BLACKHAWK!® Trouser Belt

BLACKHAWK! Trouser Belt mates up with your duty belt to increase stability.

- Full-length nylon hook-and-loop on one side; can be worn reversed without duty rig
- Black. 1½"W. Sizes: XS (22-24), S (26-30), M (32-36), L (38-42), XL (44-48) and 2X (50-54)

6R1-NP552 \$22.99

BLACKHAWK!® Web Duty Belt

BLACKHAWK! Duty Belt is extremely functional and reinforced to prevent rolling.

- Loop inner surface to mate up with inner duty belt
- Safety design to prevent assailants from releasing the buckle
- Black. 2¼"W. Sizes: S (26-30), M (32-36), L (38-42) and XL (44-48)

6R1-NP882 \$27.99



BLACKHAWK!® Molded Cordura® Duty Gear

This duty gear is made of five-layer molded laminate Cordura® nylon that resists abrasions for a crisp, professional look.

A) Single Handcuff Pouch	6R1-NP554	\$27.99
B) Double Mag Pouch - Single Column	6R1-NP562	\$35.99
Double Mag Pouch - Double Column	6R1-NP562	\$36.99
C) Taser Cartridge Pouch	6R1-NP876	\$24.99
D) Chemical Agent Pouch Large (MK4)	6R1-NP548	\$25.99
E) Chemical Agent Pouch Medium (MK3)	6R1-NP561	\$23.99
F) Expandable Baton Carrier	6R1-NP559	\$20.99
G) Latex Glove Pouch	6R1-NP556	\$20.99
H) Silent Key Holder	6R1-NP555	\$19.99
I) Radio Case	6R1-NP560	\$39.99
J) Holder for C and D Cell lights	6R1-NP553	\$9.99
K) Light Pouch 6P/G2, TL-2, Strion, Scorpion	6R1-NP558	\$22.99
L) Light Case - Stinger XT	6R1-NP810	\$31.99
M) Molded Belt Keepers	6R1-NP565	\$14.99/4 pk



5.11

5.11 Tactical® Sierra Bravo Duty Gear

Designed for maximum durability and accessibility while on the move. Precision engineered for compatibility with all standard law enforcement utility formats.

- 1680D nylon construction
- Compression molded for durability
- Reinforced high-density interior
- Lightweight, abrasion resistant
- Integrates easily into your existing layout

5.11 Tactical® Sierra Bravo Duty Belt Kit

Includes the main belt, inner belt and four individual keepers with dual-retention hook-and-loop/snap closure to keep your gear secure throughout your shift.

Black. Sizes: S-4X

6R1-NY672 \$49.99

A) Oversized Handcuff Pouch	6R1-NY190	\$17.99
B) Double Mag Pouch	6R1-NY189	\$29.99
C) Defense Spray Pouch	6R1-NY186	\$17.99
D) Latex Glove Pouch	6R1-NY188	\$15.99
E) Baton Loop	6R1-NY205	\$15.99
F) Flashlight Holder	6R1-NY187	\$15.99
G) Radio Pouch	6R1-NY191	\$29.99

Synthetic Duty Gear for Abrasion Resistance

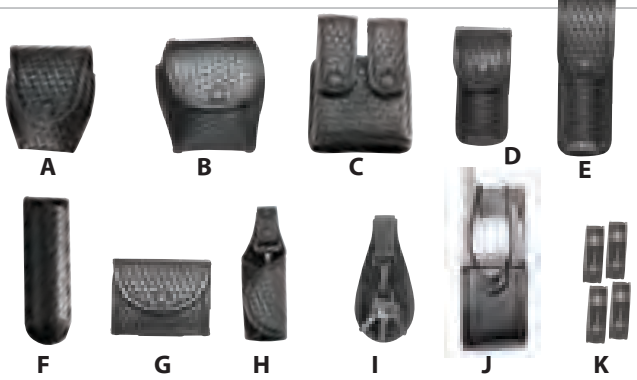

Uncle Mike's® Mirage Synthetic Accessories

Finishes: Plain or Basketweave.

A) Single Cuff Case	6R1-NP209	\$26.39
B) Double Cuff Case*	6R1-NP210	\$34.49
C) Magazine Pouch (Staggered Line)	6R1-NP216	\$39.49
D) Mark 3 Defense Spray Case	6R1-NP206	\$24.39
E) Mark 4 Defense Spray Case	6R1-NP207	\$25.69
F) Molded Expandable Baton Holder**	6R1-NP418	\$17.39
G) Double Latex Glove Case	6R1-NP217	\$20.79
H) Silent Key Ring Holder	6R1-NP204	\$18.69
I) Key Holder (Plain finish only)	6R1-NP205	\$15.59
J) Universal Radio Holder with Swivel***	6R1-NP278	\$46.69
K) Belt Keepers	6R1-NP214	\$12.49/4 pk

*NP210: Not available in Plain finish.

**NP418: Slot in back allows fast reholstering of open baton. Designed to hold a 21" expandable baton.

***NP278: Universal Radio Holder with Swivel is available in three sizes:

Size 1: 4¾"H x 2¾"W x 1¾"D. Size 3: 4¾"H x 3"W x 1½"D.

Size 4: 3¾"H x 2¾"W x 1¾"D

Uncle Mike's®

Made from the same fibers as Kodra® nylon, these synthetic accessories are constructed from a material that resists damage from abrasion, moisture and ultraviolet light.

UNCLE MIKE'S
LEW INTERIORS

MIRAGE



Basketweave

Uncle Mike's® Mirage Ultra Duty Belt

The classic look of leather with the convenience and long-lasting durability of nylon.

- Polymer stiffener
- Inner VELCRO® brand lining
- Rolled edges
- Triple-retention buckle

Black. 2"W. Sizes: S (26-30), M (32-36), L (38-42) and XL (44-48)

6R1-NP200 \$49.79+

Plain

Basketweave



BLACKHAWK!® Duty Gear Accessories

The professional look of leather with the performance of synthetic provides a functional belt with great features.

A) Handcuff Pouch-Single	6R1-LP758	\$31.99
B) Double Mag Pouch-Double Row	6R1-LP741	\$42.99
C) Double Mag Pouch-Glock 21	6R1-LP743	\$42.99
D) Chem Agent Pouch LG (MK4)	6R1-LP749	\$31.99
E) Chem Agent Pouch MD (MK3)	6R1-LP749	\$29.99
F) Expandable Baton Holder	6R1-LP752	\$25.99
G) Latex Glove Pouch	6R1-LP747	\$25.99
H) Silent Key Holder	6R1-LP751	\$25.99
I) Radio Case	6R1-LP748	\$46.99
J) Gladius Pouch	6R1-LP745	\$34.99
K) Stinger Light Pouch	6R1-LP746	\$34.99
L) Molded Belt Keeper	6R1-LP753	\$15.99/4 pk



Basketweave

BLACKHAWK!

BLACKHAWK!® Duty Belt

An extra-safety design prevents assailants from releasing the buckle.

- Reinforced to prevent rolling
- Loop inner surface to mate up with inner duty belt

Black. 2"W. Sizes: S (26-30), M (32-36), L (38-42), XL (44-48) and 2X (50-54)

6R1-LP754 \$51.99

Plain

Basketweave

Gear Clip Duty Belt Locker Hanger

Locker Hanger allows you to conveniently store and access most duty rigs.

- Attaches to the vents on a standard locker
- Accepts most standard metal hook and plastic buckle duty belts
- Hole on the outside tab lets the officer hang their uniform on the outside of the locker while getting ready

Made in the USA

6R1-LP883 \$15.29



Attach to standard locker to hang your duty rig



LawPro® Sam Browne Leather Duty Belt

Secure your items with a durable and adjustable fit.

- 2¼" W fully lined and adjustable
- Hand cut, top grain leather
- Durable cowhide

Made in the USA. Sizes: 26-68 men's even sizes. Finishes: Plain and Basketweave. Choose Nickel or Brass buckle

6R1-LR023 starting at \$37.69+

Replacement Buckle **6R1-LR035 \$3.29**



11-Piece
Leather Gear Rig

LawPro® Leather Gear Rig

Essential leather duty gear available in one value-priced kit.

- 2¼" W Sam Browne leather duty belt
- Universal Radio Holder, D-Cell Flashlight Holder, Standard Key Ring Holder, Single Handcuff Case, Emergency Glove Pouch, ¾" W Single Keeper (4-pack), OC/Mace Pouch (small or large)

Sizes: 26-68 men's even sizes. Finishes: Basketweave and Plain Leather

Starting at \$112.89+

Description	Item
Basketweave	6R1-LP124
Plain Leather	6R1-LP123

LawPro®



LawPro® Leather Duty Gear

A) Single Handcuff Case	6R1-LR025	\$21.79
B) Open Single Handcuff Case	6R1-LP024	\$22.19
C) Handcuff Strap with Life-the-Dot Snap (Note: avail. black snap only)	6R1-LR087	\$10.99
D) Double Mag Pouch	6R1-LR085	\$33.19
E) OC/Mace Pouch, MK-4 Large Size	6R1-LR093	\$24.39
F) Baton Ring	6R1-LR098	\$12.19
G) 16" Expandable Baton Holder	6R1-LR008	\$22.19
H) Emergency Glove Pouch	6R1-LR138	\$17.79
I) Standard Key Ring	6R1-LP952	\$8.79
J) Scabbard Key Ring	6R1-LR024	\$13.19
K) Deluxe Combination Keeper/Key Holder (double-duty keeper and quick-release swivel key ring holder)	6R1-LR084	\$10.99
L) Silent Key Holder	6R1-LR141	\$27.69
M) Universal Radio Holder	6R1-LR142	\$26.69
N) D-Cell Flashlight Holder	6R1-FH313	\$8.99
O) Stinger® LED/DS Holder	6R1-LR143	\$33.19
P) Streamlight Strion Holder	6R1-ZS670	\$20.29
Q) Combo Mini Mag-Lite and Knife Carrier	6R1-LP051	\$33.19
R) ¾" W Single Keeper	6R1-LR133	\$3.29
S) 1½" W Double Keeper	6R1-LR075	\$5.99

Almost 50 Years in Service

We are dedicated to serving our customers with quality products, customized services and quick deliveries. Call 800.477.7766 today to learn more.

Classic, Long-Lasting Leather for Your Duty Gear

Starting at
\$13⁶⁹



Galls® Leather Duty Gear Accessories

A) Closed-Top Cuff Case	6R1-LP148	\$29.89
B) Handcuff Strap	6R1-LP303	\$14.09
C) Double Magazine Case	6R1-LP151	\$29.89
D) Double Speedloader Case	6R1-LP152	\$25.39
E) Mark 3 Defense Spray Case	6R1-LP155	\$28.39
F) Mark 4 Defense Spray Case	6R1-LP156	\$28.89
G) Side Handle Baton Holder	6R1-LP153	\$13.89
H) Expandable Baton Holder*	6R1-LP252	\$25.39
I) Glove Pouch	6R1-LP243	\$27.69
J) Adjustable Glove Keeper**	6R1-LP357	\$23.29
K) Key Ring Holder	6R1-LP149	\$16.29
L) Universal Radio Holder	6R1-LP300	\$45.89
M) Double Ring Flashlight Holder	6R1-LP174	\$14.09
N) Belt Keepers	6R1-LP150	\$14.99/4 pk

*Available for 21" and 26" batons; 26" can also hold a Stinger® flashlight.

**Not available in High Gloss finish

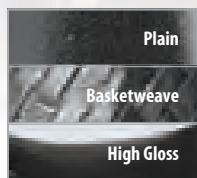

Traditional Inner Trouser Basketweave

Traditional Sam Browne Basketweave

Buckleless Inner Trouser Plain

Buckleless Outer Gear Plain

Galls® Traditional Style Duty Belts

Affordable belts made with the same durability as more expensive alternatives.

- Handcrafted, water-resistant leather
- Nickel hardware

Sizes: 28-60 even. Order one size larger than normal to ensure proper fit.

Finishes: Plain, Basketweave and High Gloss

Description	Width	Item	Price starting at
Inner Trouser	1 3/4"	6R1-LP157	\$22.99+
Sam Browne Outer Duty	2 1/4"	6R1-LP145	\$39.99+

Galls® Buckleless Belt System

Inner Trouser belt is fully lined with VELCRO® brand to interlock with the Outer Gear Belt for a complete system.

Sizes: Outer Belt is available in 28-46. Inner Belt is available in S (28-32), M (34-38), L (40-44) and XL (46-50). Finishes: Plain, Basketweave and High Gloss

Description	Width	Item	Price
Inner Trouser	1 1/2"	6R1-LP302	\$29.89
Outer Gear	2 1/4"	6R1-LP301	\$50.19

Galls® Leather Duty Gear

Galls Leather Duty Gear is available in a variety of matching accessories to fit all of your duty gear needs. With Galls brand, you can complete your duty rig just the way you want — and do it at a price that won't break your budget. Choose from three different finishes in Plain, Basketweave or High Gloss.



AIR-TEK™ by Hero's Pride

Extraordinarily scratch resistant, AIR-TEK™ duty gear and is some of the toughest and lightest in the industry. Genuine leather combined with tech-permeated materials stands up to high stress. *Meets ASTM D7255 Abrasion Test.*

AIR-TEK™ by Hero's Pride 2¼" Sam Browne Belt

Fortified with four-row stitching, durable leather and tech-infused materials, this belt is surprisingly lightweight. Water and scratch resistant for extreme endurance.

- Standard chrome-colored, double-tongued buckle hitches to center belt stud
- Free-sliding keeper fastens belt tip in place; cleans effortlessly with mild soap

Black. Size: 26-66 (even sizes).

6R1-LH206 \$66.99

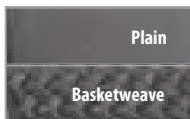

AIR-TEK™ by Hero's Pride 1¾" Garrison Belt

Heavy-duty stitching construction withstands the rigors of demanding shifts.

Black. Size: 26-66 (even sizes). Available in standard chrome-colored buckle

6R1-LH216 \$30.99



Bianchi® AccuMold® Elite Buckleless Duty Belt

No-buckle design makes it easier to attach accessories.

- Duraskin™ exterior with VELCRO® brand loop lining
- Four-part laminate construction
- Closed-cell foam for support and comfort
- Three-way retention
- Adjustable in ½" increments

Black. 2¼"W. Sizes: Even sizes 28-48". Specify exact size when ordering. Finishes: Plain and Basketweave

6R1-NP447 \$68.49

Bianchi® AccuMold® Elite Sam Browne Belt

Closed-cell foam for support and comfort.

- Duraskin™ exterior with VELCRO® brand loop lining
- Nickel hardware

2¼"W. Sizes: Even sizes 28-48". Specify exact size when ordering. Finishes: Plain, Basketweave and High Gloss

6R1-NP364 \$62.99

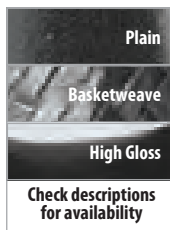

AIR-TEK™ by Hero's Pride Duty Gear Accessories

Standard Chain Handcuff Case*	6R1-LH252	\$32.99+
Hinged Handcuff Case*	6R1-LH253	\$32.99+
Large Chain Handcuff Case*	6R1-LH254	\$32.99+
Open Medium Double Magazine Case	6R1-LH226	\$35.99+
Medium Double Mag Case*	6R1-LH224	\$38.99+
Small Quad Magazine Case	6R1-LH247	\$43.99+
Large Double Mag Case*	6R1-LH225	\$38.99+
MK3 Pepper Spray Case*	6R1-LH228	\$29.99+
MK4 Pepper Spray Case*	6R1-LH229	\$30.99+
Baton with Side Handle Holder	6R1-LH250	\$10.99+
Silent Key Holder	6R1-LH251	\$21.99+
Medium Radio Case with Swivel*	6R1-LH248	\$46.99+
Combo C&D Cell Light Holder	6R1-LH220	\$10.99+
Medium Flashlight Case	6R1-LH240	\$30.99
Large Flashlight Case*	6R1-LH241	\$31.99
2¼" Belt Keepers	6R1-LH207	\$11.99+

*Specify Nickel, Gold or Black snaps



Bianchi® AccuMold® Elite

Receive the look of top-quality, molded leather but with the lightweight, easy maintenance and affordability of synthetics! It's comfortable and highly resistant to the daily scuffs and knocks of life on the job. Most items are available in your choice of finishes.

Bianchi® AccuMold® Elite Duty Gear Accessories

Finishes: Plain, Basketweave and High Gloss.

Single Cuff Case*	6R1-NP351	\$29.49
Elite Triple Threat Mag Pouch	6R1-NP005	\$29.99
Double Mag Pouch*	6R1-NP352	\$37.59
Elite Slimline Triple Mag Pouch	6R1-LR302	\$44.39
Mark 3 Defense Spray Case*	6R1-NP355	\$27.39
Mark 4 Defense Spray Case*	6R1-NP356	\$26.39
Expandable Baton Holder**	6R1-LP793	\$24.39
Elite Flat Glove Pouch	6R1-NP446	\$22.39
Silent Key Holder*	6R1-NP360	\$20.29
Elite Adjustable Radio Holder	6R1-NP445	\$39.59
Universal Radio Holder with Swivel	6R1-NP358	\$45.69
Stinger XT Light Holder	6R1-NP362	\$15.99
Elite Streamlight LED Holder	6R1-LR124	\$29.99
Elite Small Light Pouch	6R1-LR126	\$33.19
Belt Keepers*	6R1-NP354	\$12.19/4pk

*Specify regular or hidden snap

**Specify 21" or 26" baton. 26" also fits Stinger flashlight

Leather Look with Lightweight Comfort



NEW



Gould & Goodrich™ L-Force 2 1/4" Sam Browne Belt

Constructed with a polyurethane skin and a reinforcing synthetic liner with a ballistic nylon core.

- Tri release buckle for added security
- Lightweight for comfortable carry
- 2 1/4" W

Black. Size: S-2X

6R1-LH475 \$49.99

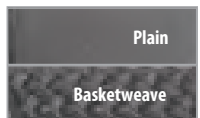

Gould & Goodrich™ L-Force Duty Gear Accessories

A) Chain Handcuff Case*	6R1-LH483	\$24.99
B) Double Handcuff Case*	6R1-LH477	\$29.99
C) Hinged Handcuff Case*	6R1-LH484	\$24.99
D) Single Magazine Pouch	6R1-LH480	\$19.99
E) Open Top Double Magazine Pouch	6R1-LH478	\$24.99
F) Double Magazine Pouch	6R1-LH479	\$32.99
G) Pepper Spray Pouch	6R1-LH482	\$22.99
H) Baton/Flashlight Holder	6R1-LH473	\$6.99
I) PR-24 Holder	6R1-LH474	\$8.99
J) Expandable Holder	6R1-LH476	\$20.99
K) Closed Top Flashlight Pouch	6R1-LH481	\$24.99
L) Belt Keeper (Single)	6R1-LH485	\$2.99
M) Belt Keepers (4 Pack)	6R1-LH487	\$10.99

*Does not fit ASP handcuffs

Gould & Goodrich™ L-Force Duty Gear

L-Force duty gear combines the classic, professional look of leather with the lightweight affordability of nylon gear. Constructed from durable, mil-spec ballistic nylon with a polyurethane skin. Accessories feature black snaps, are thermo-formed, hard-shell molded and fit belts up to 2 1/4" W.

Extremely Durable and Functional Leather



Leather Trouser
Nickel, Basketweave

Traditional Style Duty
Two-Row, Brass,
Basketweave

Buckleless Inner
Plain

Buckleless
Outer Duty
Plain

Gould & Goodrich™ Leather Trouser Belt

Top-grain leather belt with your choice of removable buckle.

- Hand creased
- Rubbed edges
- Buckle: Nickel or Brass

Black. 1¾"W. Sizes: Even waists 28-60. Finishes: Plain and Basketweave

6R1-LP072 starting at \$40.59+

Gould & Goodrich™ Traditional Style Duty Belts

Traditional style belts conform to your body for comfort.

- Top-grain leather
- Fully lined
- Buckle: Nickel or Brass

Black. 2¼"W. Sizes: 28-54. Finishes: (Two-Row) Plain, Basketweave and High Gloss. (Four-Row) Plain and High Gloss

Starting at \$65.99+

Two-Row **6R1-LP074**

Four-Row **6R1-LP073**

Gould & Goodrich™ Buckleless Belts

Top-grain leather belt features VELCRO® brand fastening on inner sides to eliminate need for belt keepers.

Inner: Black. 1½"W. Sizes S-XL. Finishes: Plain and Basketweave

6R1-LP040 starting at \$37.59+

Outer Duty: Hidden brass hooks keep belt securely fastened. Black. 2¼"W. Sizes 28-50. Specify exact waist size. Finishes: Plain and Basketweave

6R1-LP041 starting at \$65.29+

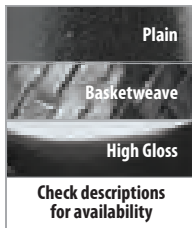

Check descriptions for availability



GOULD & GOODRICH™



Gould & Goodrich™ Leather Duty Gear Accessories

- | | |
|---|--------------------------------|
| A) Handcuff Strap with Black Snap | 6R1-LP099 \$10.39 |
| B) Open-Top Cuff Case (Plain and Basketweave) | 6R1-LP100 \$25.69 |
| C) Standard Cuff Case with Snap* | 6R1-LP097 \$29.99 |
| D) Double Cuff Case | 6R1-LP176 \$39.39 |
| E) Handcuff Case for ASP® Cuffs RS164 | 6R1-LP473 \$41.69 |
| F) Handcuff Case with Integrated Glove Pouch | 6R1-LR559 \$53.29 |
| G) Double Mag Pouch* | 6R1-LP053 \$36.99 |
| H) Mark 3 Mace® Case with Snap* | 6R1-LP058 \$26.39 |
| I) Key Keeper* | 6R1-LP078 \$13.39 |
| J) Cell Phone Holder | 6R1-LR281 \$36.29 |
| K) Snap Belt Keepers* | 6R1-LP093 \$15.89+/4 pk |

*Specify brass or nickel snap

Gould & Goodrich™ Leather Duty Gear

Long lasting, durable and water repellent. Our premium vegetable-tanned cowhide is an unsurpassed value. Top-grain leather is tanned to conform to your body.



Visit us online for pricing on additional options.

and Synthetic Duty Gear



Safariland® Duty Belt Accessories

Finishes: Plain, Basketweave and High Gloss

A) Standard Cuff Case*	6R1-LP081	\$27.99
B) Hinged Cuff Case*	6R1-LP141	\$26.99
C) Double Cuff Case*	6R1-LP177	\$40.39
D) Slimline Double Mag Holder	6R1-LP665	\$36.99
E) Double Mag Holder*	6R1-LP127	\$39.99
F) Triple Mag Holder	6R1-LP666	\$41.49
G) Mark 3 Spray Holder	6R1-LP130	\$27.29
H) Mark 4 Spray Holder	6R1-LP131	\$27.29
I) Expandable Baton Holder	6R1-LP244	\$28.39
J) Glove Pouch with Hook/Loop Closure	6R1-LP203	\$15.99
K) Key Keeper	6R1-LP135	\$15.29
L) Radio Holder with Swivel	6R1-LP005	\$41.99
M) D-Cell Flashlight Holder	6R1-LP143	\$8.79
N) Mini Flashlight Carrier for Stinger®	6R1-LP629	\$24.99
Mini Flashlight Carrier for PolyStinger®	6R1-LP632	\$24.99
Mini Flashlight Carrier for SureFire® 6P	6R1-LP633	\$24.99
O) Snap Belt Keepers Reg*	6R1-LP137	\$12.59 /4 pk
Hidden Snap Keepers*	6R1-LP137	\$19.99 /4 pk

*Specify regular or hidden snap



Safariland® Buckleless Inner Belt

Inner Trouser Belt is lined with hook-and-loop on inner sides, so there's no need for belt keepers. Can be worn by itself or with outer duty belt below.

- Safarilaminate™
- Reversible

1½"W. Sizes: S (28–32), M (34–36), L (38–42) and XL (44–46)

6R1-LP071 \$34.99

Safariland® Outer Duty Belt

Outer Duty Belt securely fastens to inner belt, promoting worry-free wear and comfort.

- Safarilaminate™
- Hook lining attaches to loop of inner trouser belt for a Buckleless™ System
- Hidden brass hook-and-loop closure eliminates belt keepers

2¼"W. Sizes: S (28–32), M (34–36), L (38–42) and XL (44–46)

6R1-LP070 \$67.59

Safariland® Sam Browne Belt

Sam Browne belts withstand the harshest conditions and feature a sliding keeper.

- Safarilaminate™
- Double-tongued buckle and center belt stud; buckle: Nickel or Brass-plated

2¼"W. Sizes: S (28–32), M (34–36), L (38–42) and XL (44–46)

\$66.59

Two-Row Stitch Belt (unlined) **6R1-LP132**

Four-Row Stitch Belt (suede-lined) **6R1-LP133**

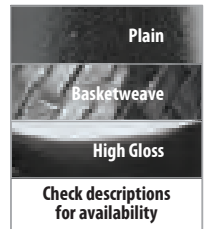

Safarilaminate™

Safarilaminate™ is a unique thermal-laminate process used for the construction of many Safariland products. This material is impervious to moisture and bloodborne pathogens, and it does not break down like natural materials — making for an extremely durable and long-term, professional-looking product.

Single Retention for Efficient Draw

Starting at \$49.99

Fits automatics

Fits revolvers

Nylon

Fits revolvers

Synthetic Leather

Thumb-Break Retention

GALLS®

Galls® Holsters

For an amazingly low price, you can receive our popular hard shell holster.

- Choose from nylon or durable synthetic leather
- Single retention with thumb break
- Fits belts to 2¼"W

Finishes: **LP637** Plain, Basketweave and High Gloss. Weapon Fits: Glock 17/22; Beretta 92F and Smith & Wesson J&K frame revolvers. **NP512** fits additional Glock 19/23, 20/21, 31/32; Sig P225, P226, P228, P229 and LG autos. Specify gun make and model, right or left hand

Description	Item	Price
Nylon	6R1-NP512	\$50.79
Synthetic Leather	6R1-LP637	\$55.39

BIANCHI

AccuMOLD

Fits automatics and revolvers

Bianchi® AccuMold Cruiser Holster

Low-profile design and high-ride belt position for optimum comfort.

- Ballistic weave trilaminate
- Adjustable, integral thumb break
- Weatherproof and washable
- Fits automatics and revolvers
- Fits belts to 2¼"W

Weapon Fits: Glocks 17/22, 19/23, 20/21; Beretta 92F; Sig P220/P226, P228/P229 and Smith & Wesson LG autos. Specify gun make and model, right or left hand

6R1-NP163 \$60.89

Plain

Basketweave

High Gloss

STX Tactical™

Check descriptions for availability

Safariland® 7TS™ ALS® 7390 Mid-Ride Duty Holster

Handles extreme temperatures of 300°F to -50°. Features precision injection molding and is incredibly lightweight.

- SafariSeven™, DuPont™ nylon blend is completely non-abrasive to a firearm's finish
- Level I Retention™
- Automatic Locking System™ (ALS) internal retention in an open-top design
- Simple straight-up draw with deactivated release
- Raised stand-off surfaces allow dirt and moisture to quickly clear any contact with the firearm
- Maintains shape and function when submerged in water
- Matte finish decreases reflection

Weapon Fits: Beretta 92, Glock 17.
Colors: Black and Flat Dark Earth Brown

6R1-NP666 \$72.99

BIANCHI

AccuMOLD

Bianchi® AccuMold® Defender Holster

Enhanced security with a reinforced thumb break and molded Tension Strips™.

- Ballistic weave trilaminate
- Pinch® Retention Device
- Standard ride, jacket slot belt loop
- Weatherproof and washable
- Fits belts to 2¼"W

Weapon Fits: Glocks 17/22, 19/23; Beretta 92F; Sig P220/P226, P228/P229 and Smith & Wesson LG autos. Specify gun make and model, right or left hand

6R1-NP162 \$97.49+

Safariland® Top Gun Mid-Ride Holster

Level I Retention™ holds your weapon securely even after rigorous daily use.

- SafariLaminate™ with suede lining
- Low-profile thumb break with one-way snap
- Top draw with a straight drop cant
- Universal belt loop anchors holster onto belt
- Fits belts up to 2¼"W

Weapon Fits: Glocks 17/22, 19/23, 20/21; Beretta 92F and Sig P220/P226, P228/P229. Finishes: Plain, Basketweave and High Gloss. Specify gun make and model, right or left hand

6R1-LP055 \$154.99

Double Retention for Double Safety



Uncle Mike's® Dual Retention Holsters

The Jacket Slot Holster supplies endless comfort because it is designed for adjustable vertical, butt forward or muzzle forward draw angles. The Pro-2® Holster and its internal trigger guard provide greater levels of security.

- Dual retention
- Kodra® nylon, closed-cell foam and soft nylon lining
- Adjustable tensioning device
- Fits belts up to 2¼"W
- Fits automatics and revolvers

Weapon Fits: (Jacket Slot) Glock 17/22, 19/23, 20/21; Beretta 92F and Sig P220/P226, P228/P229. (Pro-2®) Glock 17/22, 19/23/30, 20/21; Beretta 92F; Sig P220/P226, P228/P229 and Smith & Wesson LG autos. Specify gun make and model, right or left hand

Description	Item	Price
Jacket Slot	6R1-NP125	\$66.99
Pro-2®	6R1-NP509	\$83.29

Jacket Slot



Pro-2®



BLACKHAWK!® SERPA™ Level II Duty Holster

This unique holster design allows you to forget old-fashioned thumb breaks that slow your draw and complicate reholstering. The patented SERPA™ Technology lock auto-engages the trigger guard and won't let go until released with the trigger finger beside the holster body.

- Carbon fiber composite construction
- Allows for rapid unlock and draw in one smooth, straight action
- Dual Retention, AutoLock™ keep pistol safe from grab attempts
- No snaps or hoods to accidentally open

Weapon Fits: Glock 17/22, 19/23, 20/21; Beretta 92F and Sig P220/P226. Specify gun make and model, right or left hand

6R1-LP569 \$89.99



See our comprehensive collection of shooting accessories and range gear, starting on p. 336.



Fits automatics and revolvers

SafariLaminate™ Finish

Safariland® 6280 Mid-Ride Holsters

Revolutionary rotating thumb break provides a reliable and secure fit.

- Level II Retention™ with Self Locking System™ (SLS)
- Top draw/straight drop cant
- Available in SafariLaminate™ finish or STX Tactical™ finish with suede lining
- Fits belts up to 2¼"W
- Compatible with M3/TLR-1, M6/TLR-2, M3X/M6X ITI, Surefire® X200/X300 light attachments

Finishes: LP198 Plain, Basketweave and High Gloss. LP425 STX Tactical™. Weapon Fits: LP198 Glock 17/22, 19/23, 20/21; Beretta 92F; Sig P220/P226, P228/P229 and Smith & Wesson LG autos. LP425 Glock 17/22, 19/23; Beretta 92F and Sig P220/P226, P228/P229. Specify gun make and model, right or left hand

Description	Item	Item
STX Tactical™	6R1-LP425	\$104.99
SafariLaminate™	6R1-LP198	\$145.99



STX Tactical™ Finish



Safariland® 295 Leather Easy Draw Retention Holster

This holster's ingenious trigger guard hood has made it a popular design with law enforcement agencies around the world.

- Top-grain leather
- Resistant to grab attempts but easy to draw
- Steel reinforced shank for durability
- Low-ride holster
- Dual belt tensioning device
- Fits belts up to 2¼"W

Black. Weapon Fits: revolvers with 4"L barrels.

Finishes: Basketweave, High Gloss and Plain

6R1-LP059 \$179.99

Basketweave

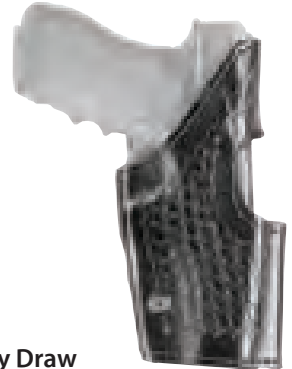

Safariland® STX Finishes Guide

SafariLaminate™: a unique thermal-laminate process used for the construction of many Safariland products. This material is impervious to moisture and bloodborne pathogens, and it does not break down like natural materials — making for an extremely durable and long-term, professional-looking product.

STX Tactical Finish: textured finish helps to reduce wear-and-tear scratches on the product. It's famous for its incredible strength, abrasion resistance and protective qualities. It is heat laminated and molded to the exact shape of the weapons and accessories for better security.

Tri-Level Retention



Black

Safariland 7TS™ ALS™ 7360 Mid-Ride® Duty Holster

Handles extreme temperatures of 300°F to -50°. The 7TS™ Series is extremely rugged and offers the ultimate in durability. This holster features precision injection molding and is incredibly lightweight.

- SafariSeven™, DuPont™ nylon blend is completely non-abrasive to a firearm's finish
- Level III Retention™
- Automatic Locking System™ (ALS) internal retention in an open-top design
- Simple straight-up draw with deactivated release
- Interior raised stand-off surfaces create air space around the weapon, allowing dirt and moisture to quickly clear any contact with the firearm
- Maintains shape and function when submerged in water
- Matte finish decreases reflection
- Compatible with all Safariland® holster mounting options

Weapon Fits: Beretta 92 and Glock 17.

6R1-NP665 \$82.99+

Black

Flat Dark Earth
Brown



Mirage Slimline
Plain



Mirage
Basketweave



Uncle Mike's® Slimline™ Pro 3® Duty Holster

SlimLine™ is about ½" thinner than the original Pro-3.

- The classic look of leather with the long-lasting durability of nylon
- Internal locking device
- Adjustable thumb break
- Tensioning device maintains pressure along entire length of the gun
- Fits belts up to 2¼"W

Description	Item	Price
Slimline	6R1-NP451	\$90.39
Mirage Slimline	6R1-NP450	\$101.49



Ergonomic, thin
profile minimizes
obstruction
against body

Plain

Basketweave

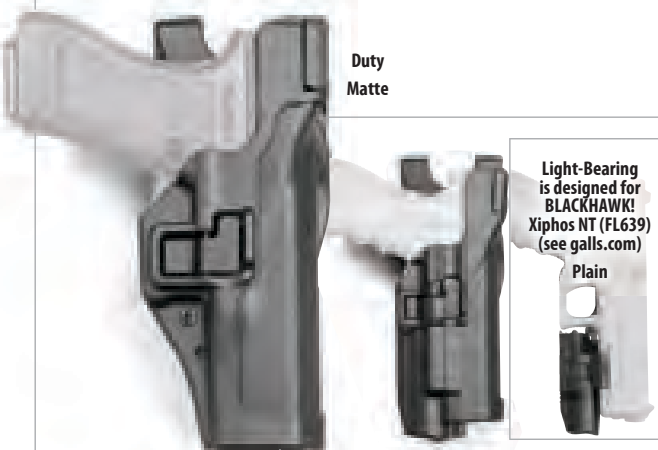

Duty
Matte

Light-Bearing
is designed for
BLACKHAWK!
Xiphos NT (FL639)
(see galls.com)

Plain



BLACKHAWK!® SERPA Level III Duty Holsters

AutoLock™ System ensures immediate security and locks weapon into place upon reholstering.

- Durable injection-molded carbon fiber composite construction
- Level III Retention™
- Putting hood in place, restores holster to triple retention

Weapon Fits: (Duty) Glock 17/22, 19/23, 20/21; Beretta 92F; Sig 220/226, 228/229 and Smith & Wesson M&S. (Light-Bearing) Glock 17/22 and 20/21. Specify gun make and model, right or left hand

Holster Type	Finishes	Item	Price
Duty	Matte	6R1-LP550	\$94.99
Duty	Plain, Basketweave	6R1-LP568	\$99.99
Light-Bearing	Matte	6R1-LP536	\$114.99
Xiphos NXT Gun Mounted Flashlight		6R1-FL639	\$199.99

Matte

Plain

Basketweave

for Maximum Security

Thumb-Activated
Pivot Guard



Basketweave

BLACKHAWK!® Epoch Level III Light-Bearing Duty Holster

Delivers three levels of retention for high security.

- Constructed of proprietary polymer carbon fiber blend
- Passive retention detent adjustable screw
- Patent-pending retention system engages the pistol's ejection port when holstered
- Thumb-activated pivot guard
- Epoch auto-lock thumb release (patent pending)

Made in the USA. Fits popular lights TLR-1 TLR-2, X300, X400. Fits Glock 17/22

6R1-LP966

Matte
Plain/Basketweave

\$109.99
\$126.99

BLACKHAWK!

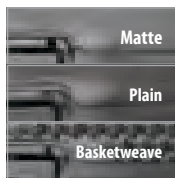

Basketweave



STX Tactical™ Finish

Plain

Basketweave

High Gloss

SafariLaminate™

Finishes

Safariland® 6360 ALS Holsters

Automatic Locking System™ (ALS) has an internal device that secures the weapon in all directions.

- Level III Retention™ with Self Locking System™ (SLS)
- Universal Belt Loop (UBL) enables mid-ride and low-ride
- Smooth, straight-up draw when all releases are activated

Weapon Fits: Glocks 17/22, 19/23, 20/21 and

Sig P220/P226, P228/P229. Specify gun make and model, right or left hand.

Description

STX Tactical™

SafariLaminate™

Item

6R1-LP416

6R1-LP415

Price

\$119.99

\$155.99



**GOULD
& GOODRICH**

High Gloss



Gould & Goodrich™ Phoenix K Force Triple Retention Holster

Advanced ergonomic design provides speed and control in one fluid motion.

- Hood can be released and still have weapon retention
- Thumbslide disengages both the internal locking device and the rotating hood
- Thermoformed Kydex body
- Suede lined to protect the gun's finish

Weapon Fits: Glock 17, 19, 20, 21; Smith & Wesson MP40 and M 45; Sig P220, P226, P228, P229.

Finishes: Plain, Basketweave and High Gloss. Specify gun make and model, right or left hand.

6R1-LP653 \$158.39+



Visit us online for pricing on additional options.

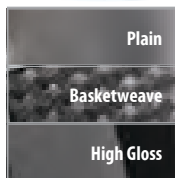

SafariLaminate™

Basketweave



SAFARILAND

Plain

Basketweave

High Gloss

Nylon Look

Safariland® 070 SSIII Holsters

Mid-ride belt position and slightly forward grip cant allows for a quick, easy draw.

- Level III Retention™
- Top-snap thumb break and middle-finger release tab
- Patented molded ejection port
- Rigid Posi-Lock Belt Loop™
- Available in SafariLaminate™ for the look of leather, or nylon look for a smooth nylon finish

Weapon Fits: Glocks 17/22, 19/23, 20/21; Beretta 92F; Sig P220/226, P228/P229 and Smith & Wesson LG autos. Specify gun make and model, right or left hand

Description

SafariLaminate™

Nylon Look

Item

6R1-LP043

6R1-NP129

Price

\$204.99

\$167.89

VISIT US ONLINE

Shop hundreds of duty holsters and accessories online at: galls.com/holsters-duty-gear

Ordering online? Use your **PROMOTIONAL CODE** from the back cover

800.477.7766 • galls.com

299

Holsters and Accessories for Your TASER®

BLADETECH™

Bladetech™ TASER® X26P Holster with Tek Lok Attachment

Bladetech's Tek Lok attachment makes it easy to share tasers without dismantling your entire belt rig.

- Durable Kydex® construction; lightweight design
- Thumb snap/hood combination provides quick access and secure retention
- Tek Lok belt attachment allows easy detachment from the duty belt
- The belt attachment can be set to a variety of angles to best fit on your duty rig; fits up to 2¼" duty belt

Black

6R1-LR305 \$39.99



Tek Lok belt attachment allows easy detachment from the duty belt



BLADETECH™

Bladetech™ TASER® X2 Holster with Tek Lok Attachment

Made from rugged Kydex® with a combination thumb snap/hood to keep your TASER® X2 secure and ready at a moment's notice.

- Tek Lok belt attachment allows easy detachment from the duty belt
- The belt attachment can be set to a variety of angles to best fit on your duty rig
- Fits up to 2¼" duty belt

Black

6R1-NP960 \$39.99



Basketweave

Safariland® 6312 ALS EDW Holster with Clip for TASER® X26

Automatic Locking System™ (ALS) securely locks the Electronic Discharge Weapon (EDW) into place without any straps or snaps to manipulate.

- Oversized release is ergonomically designed and completely operable with the thumb
- Straight up draw makes it instinctive to use; ambidextrous
- Clip-on style belt loop with the ability to fit 1½", 1¾", 2" and 2¼" belt widths
- Closed-top design protects the LED portion of the TASER® X26 from abrasion and impact
- Closed bottom with a drain hole to protect the cartridge
- Simple draw with low-profile ALS mechanism provides an instinctive ease of draw and helps guard against takeaway attempts
- Safety on the TASER® is automatically activated once it is reholstered

Black. Basketweave or STX Tactical™ finish. Weapon Fits: TASER® X26™

6R1-LP646 \$75.19



Hi-Gloss

Safariland® 6520 TASER® Holster

SLS rotating hood allows for a faster, single-motion draw and greater protection against attempted weapon takeaways.

- Durable Safarilaminat™ construction with suede lining
- Level II retention
- Quick detach belt loop makes taking off the belt very easy
- Closed bottom with drain hole to protect the cartridge and officer

Black. Plain, Basketweave, Hi-Gloss, STX Tactical™ or Nylon finish. Weapon Fits: TASER® X26™

6R1-LP773 starting at \$75.69+



Visit us online for pricing on additional options.



BLACKHAWK!® SERPA™ TASER® Holster

Exchange the SERPA TASER® holster without removing other gear from your duty rig.

- SERPA™ Active Retention Safety System
- Cross draw design and rock forward draw (versus traditional straight draw) to prevent confusion with pistol holster
- Automatically engages safety when reholstering and retains probes in case of activation within holster
- TASER® is fully stabilized, even with an optional camera unit
- Completely covered trigger while TASER® is in holster

Black. Weapon Fits: TASER® X26™

Description	Item	Price
Matte	6R1-LP611	\$45.99
Plain and Basketweave	6R1-LP607	\$61.99



Basketweave



TASER® Holster Finishes (Check descriptions for availability)



BLACKHAWK!® TASER® X26 Side Mount Plate

This adapter plate allows you to mount the TASER® X26 Cartridge Holder to your TASER® X26 Duty Holster and still save space on your duty belt. The unique front side positioning allows for fast reload without taking up too much space on the belt.

- Ideal for officers with small waists
- Perfect for mounting on a crowded MOLLE vest
- Positions spare cartridge to outboard side of TASER® X26 Duty Holster (sold separately)
- Available in right- or left-hand models; fits duty belts up to 2¼" wide

6R1-LR056 \$12.89



BLACKHAWK!® Cordura™ TASER® Cartridge Case

Traditionally styled nylon gear is made from tough Cordura® for ultimate durability.

- Abrasion resistant
- Four layers of laminate Cordura® with waterproof closed-cell foam padding
- Belt loop fits up to 2¼" wide belts

6R1-NP877 \$17.99



Concealable Options for Covert Carry



**SERPA™
with Paddle Platform
Carbon Fiber**

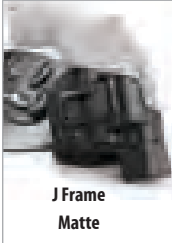

**J Frame
Matte**



Each holster style comes complete with both a belt loop and paddle platform

Paddle Platform

Belt Loop Platform



BLACKHAWK!® CQC SERPA™ Holsters

Close Quarters Concealment holsters have the SERPA Technology Lock™ which engages the trigger guard.

- Molded carbon fiber composite
- Level II retention
- Speed cut in front for a fast draw and covered trigger for added safety
- Cut down body aids in concealment and allows a full combat grip before you draw
- Belt loop adjusts to any belt width
- Includes belt loop and paddle platform

Weapon Fits: Glock 17/19/20/21/22/23/26/27; Beretta 92P and Sig P228/P229, complete list online. Specify gun make and model, and left or right hand

6R1-LP427

Matte **\$44.99**
Carbon Fiber **\$54.99**

J Frame Holsters: Weapon Fits: Smith & Wesson J frames, except .357 magnum. Matte finish.

6R1-LP563 \$44.99



Blade-Tech™ Revolution Klipt Appendix Holster

Developed in conjunction with covert special operators in CQB environments, this holster is ultra-concealable while allowing quick access.

- Injection-molded polymer construction
- Ultrathin signature with virtually no "print"
- Appendix carry for quick access
- Can be carried behind the back or inside the waistband
- Fits all belts up to 1¾"W

Weapon fits: Glock 42, Smith & Wesson M&P Shield, Springfield XDS, Ruger LC9

6R1-NY388 \$29.99



Ultrathin design with quick access

BLACKHAWK!® GripBreak™ Leather Holster

Secure weapon retention in a premium Italian leather design.

- Thumb-release lever is deactivated when the user obtains a proper shooting grip
- Molded release guard
- Premium, drum-dyed Italian leather outer shell
- Inner molded shell for a precise fit to your sidearm
- Fits belts up to 1½" wide

Weapon Fits: Glock 17/19/22/23/26/27/31/32/33 and Smith & Wesson M&P 9/.357/.40/.45. Specify gun make and model, right or left hand

6R1-LP964 \$76.99

BLACKHAWK!® Sportster SERPA™ Holster

In addition to the features of other SERPA holsters (above), the Sportster includes:

- Passive retention detent adjustment screw
- Reinforced full master grip and superior draw technique
- Immediate retention and audible click upon reholstering for security

Weapon Fits: Glock 17/22, 19/23, 26/27, complete list online. Specify gun make and model, and left or right hand

6R1-LP616 \$33.99

VISIT US ONLINE

24/7 Ordering

Online ordering is available anytime with exclusive savings and deals on more than 360,000 products @ galls.com.

BLACKHAWK!® A.R.C. IWB HOLSTER

The Appendix Reversible Carry (A.R.C.) Inside the Waistband (IWB) Holster from BLACKHAWK! is designed to be extremely versatile and comfortable for those users who prefer the appendix carry position.

- Injection-molded polymer construction
- Fully ambidextrous design
- Adjustable clips for 1½" to 1¾" belts
- Passive retention detent with adjustment screw
- Allows for use of rear-mounted red dots

Urban Gray. Weapon fits: Glock 42, 17, 22, 19, 23; Smith & Wesson M&P Shield

6R1-LH360 \$21.99

Tuckable C-Clip design for attachment

Polymer Construction, All-Weather Durability



Concealment Paddle
Black



Concealment Belt Slide
Black



Concealment Belt Clip
Black



Safariland® ALS™ Holsters

Handles extreme temperatures of 300°F to -50°. The 7TS™ Series is extremely rugged and offers the ultimate in durability. This holster features precision injection molding and is incredibly lightweight.

- Proprietary nylon blend that is completely non-abrasive to a firearm's finish
- Automatic Locking System™ (ALS) internal retention in an open-top design, providing excellent retention with an ergonomic, simple straight up draw once the release is deactivated
- Raised stand-off surfaces in interior of holster creates air space around the weapon, allowing dirt and moisture to quickly clear any contact with the firearm
- Can be submerged in water indefinitely and still maintain shape and function
- Matte finish decreases reflection and can be maintained with a simple scouring pad
- Compatible with all Safariland holster mounting options
- Open-top design without SLS for quick retrieval of weapon

Weapon Fits: Beretta 92, Glock 17 and 22

Model #7379 Concealment Belt Clip: Features a 745BL Belt Clip for easy attachment and detachment from belt

6R1-LR217 \$38.19

Model #7377 Concealment Belt Slide: Injection-molded belt loop is user adjustable for cant and can be worn cross draw

6R1-LR216 starting at \$38.19+

Model #7378 Concealment Paddle

- Injection-molded belt loop is user adjustable for cant and can be worn cross draw
- Injection-molded paddle is highly concealable and rides close to the body

6R1-LR212 starting at \$42.59+



Visit us online for pricing on additional options.



Safariland® ALS™ Paddle Holster

Automatic Locking System™ (ALS) secures weapon once holstered, providing an extra measure of security from standard open-top holsters.

- Simple straight up draw secures weapon once ALS™ is deactivated
- Suede lining
- Open-top design; comes with a belt loop to fit 1½" and 1¾" belt slots
- Injection-molded construction that rides close to the body

Black. Weapon Fits: Glocks 17/19/20/21/22/23; Sig P220/P226, P228/P229 and Smith & Wesson M&P. Finish: STX™ Plain. Right hand only. Left hand special order

6R1-LP610 starting at \$59.89+



Model #578 fits
over 175 firearms
Standard

Model #576 fits
over 100 firearms
Compact



Safariland® GLS™ Pro-Fit™ Concealable Holsters

Safariland brings the unique Grip Lock System™ (GLS) technology and SafariSeven™ together in a holster engineered to fit a plethora of guns with Pro-Fit™ technology. GLS™ secures the weapon when holstered and releases it upon application of the middle finger with a standard shooting grip for a more natural and safer release.

- SafariSeven™ nylon blend construction; GLS™ and Pro-Fit™ technologies
- Available in Standard (83), Long (683) and Compact (283) length models

Model #576: Adapts to securely fit over 100 firearms. Hi-ride injection-molded belt loop fits ½" belt widths.

6R1-LH310 \$44.99

Model #578: Adapts to securely fit over 175 firearms. Injection-molded paddle and belt loop is user adjustable for comfort and can be worn cross draw.

6R1-LH380 starting at \$49.99+

Leather Construction for Classic Comfort



Gould & Goodrich™ Three Slot Pancake Holster

This finely molded holster hugs your body comfortably for maximum concealment.

- Top-grain leather construction
- 3 slots allow straight up or tilted wear on strong side or cross draw
- Reinforced thumb break
- Coated snap to help protect your gun
- Front cut down for quick draw
- Fits belts up to 1¾"W

Weapon Fits: semi-automatics and revolvers. Specify left or right hand

6R1-LP068 \$42.59



Gould & Goodrich™ Three Slot Pancake Holster

This holster features hand-formed leather for a long-lasting professional look and performance.

- Top-grain leather construction
- 3 slots allow straight up or tilted wear on strong or weak side
- Thumb break/snap
- Molded sight track
- Fits belts up to 1¾"W

Weapon Fits: Glocks 17/22, 19/23, 20/21; Beretta 92F; Sig P220/P226, P228/P229 and Smith & Wesson K&J frames. Specify left or right hand

6R1-LP010 \$46.69



Aker® Flatsider Leather Belt Slide Holster

Holster pocket is formed away from the body for a more comfortable wear.

- Thumb break
- Adjustable tension screw
- Curved belt slots for stability and concealment
- Use with standard or shortened barrel weapons

Weapon Fits: Glocks 17/22, 19/23, 26/27; Beretta 92F and Sig P220/P226, P228/P229. Specify gun make and model, and left or right hand

6R1-LP341 \$67.49



Gould & Goodrich™ Pancake Holster with Mag Pouch

This unique pancake holster is designed to hold an extra mag in the same holster as your weapon, eliminating the need to carry a separate mag holder.

- Top-grain leather
- Open muzzle and a molded sight track
- Mag compartment with tension screw for adjustment
- Thumb break/snap
- Fits belts up to 1¾"W

Weapon Fits: Glocks 17/22, 19/23, 20/21; Beretta 92F; Sig P220/P226, P228/P229 and Smith & Wesson LG autos. Specify gun make and model, and left or right hand

6R1-LP267 \$69.79



VISIT US ONLINE

Shop our selection of holsters developed by the most trusted names in the industry:
galls.com/holsters-duty-gear



DeSantis® 001 Leather Thumb-Break Holster

Classic leather thumb-break holster with an adjustable fit.

- Made of genuine leather
- Molded to the handgun for a precise fit
- Thumb break for secure retention, plus a tension screw so you can adjust the fit
- Three-slot design allows the wearer to adjust the cant of the holster
- Lined to protect the weapon finish
- Fits belts 1¾"W

Made in the USA. Black. Weapon Fits: Glocks 17, 19, 21, 26; S&W K-frames, M&P 40, 5904; Sig P220, P226, P229; Springfield XD45; Beretta 92F

6R1-LP989 \$72.49



Aker® Leather Inside the Waistband Holster

The most comfortable Inside the Waistband Holster we sell. This holster has many features, which improve the wear, functionality and comfort of the IWB design.

- Wide belt loops keep the pistol level on the belt and prevent movement when in action, keeping the gun closer to the body for better concealment
- Reinforced opening keeps the holster open once the gun is drawn so it can easily be reholstered when needed
- Quick disconnect belt loops allow for easy attachment without taking off your belt

Weapon Fits: Glock 17/22, 19/23, 26/27, Smith & Wesson M&P 9/40

6R1-LP999 \$80.00



Tuckable C-Clip design for attachment

Ankle and Shoulder Holders for Discreet Carry



Gould & Goodrich™ Neoprene Ankle Handcuff/Mag Holder

Holds a pair of handcuffs and one magazine, knife or multi-tool.

- Genuine sheepskin padding
- Lightweight neoprene ankle wrap provides greater comfort and stability than nylon
- One pocket holds chain or hinged cuffs
- Other pocket holds weapon mag
- Elastic pouches fit a wide variety of handcuffs and magazines
- Attached D-ring for optional leg garter
- Ambidextrous design

6R1-LP824 \$33.69

Gould & Goodrich™ Leg Garter for Ankle Holster **6R1-LP822 \$17.79**



Gould & Goodrich™ Neoprene Ankle Holster

Quality ankle holster at an affordable price.

- Genuine sheepskin padding
- Lightweight neoprene ankle wrap provides greater comfort and stability than nylon
- Adjustable safety strap to fit a wide variety of weapons
- Attached D-ring for the optional leg garter when extra support is needed
- Available in right or left hand

Fits most small to medium frame guns. Specify gun make and model

6R1-LP821 \$49.99

Gould & Goodrich™ Leg Garter for Ankle Holster **6R1-LP822 \$17.49**



Uncle Mike's® Ankle Holster

This slim ankle holster is super concealable and super comfortable.

- Cordura® nylon
- Slim silhouette
- Adjustable and removable calf strap

Weapon Fits: Glocks 26/27; Smith & Wesson J frames. Specify make, model and left or right hand

6R1-NP032 \$40.49



Gould & Goodrich™ Ankle Holster

The wide ankle band, sheepskin padding and adjustable straps let you wear this ankle holster comfortably, even for extended periods of time.

- Sheepskin padding prevents chafing
- Wide, neoprene ankle band with VELCRO® brand closure helps holster stay put
- Removable calf strap
- Reinforced thumb break

Fits: Glocks 26/27; Smith & Wesson J frames. Specify make, model and left or right hand

6R1-LP234 \$64.99



Sheepskin Padding



Worldwide Shipping

Wherever your job takes you, we can ship the gear you need in the U.S. or overseas.



Tan

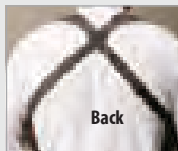

Back



Tan



Aker® Flatsider XR7 Leather Shoulder Holster

Comfort-Flex™ harness prevents center piece from riding up and placing weight on base of the neck.

- Twin harness tabs keep gun grip close by. Features dual magazine pouch on opposite side of firearm
- Choose optional off-side accessories to help balance rig

Black or Tan. Specify make, model and left or right hand

6R1-LP305 \$146.94

Mag Tie-Down **6R1-LP328 \$11.19/ea**
 Holster Tie-Down **6R1-LP327 \$10.49/ea**

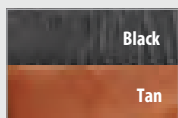

Black

Tan

VISIT US ONLINE



Find more duty gear from your favorite brands online at: galls.com/holsters-duty-gear



Magazine/Handcuff
Chestnut Brown

EXCLUSIVE ITEM

Single Cuff
Chestnut Brown

Gould & Goodrich™ Gold Line Cases

Premium leather accessories in your choice of style and color.

- Top-grain leather
- Paddleback with tension screw to adjust for a firm or easier draw
- Hold most standard chain or hinged cuffs
- Specify make and model of weapon, right or left hand

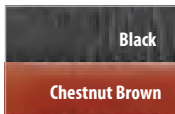

Description	Holds	Item	Price
Magazine/Handcuff	Double-stack mags and most standard chain or hinged cuffs	6R1-LP019	\$43.99
Single Cuff	Single set of cuffs	6R1-LP310	\$30.89

Gould and Goodrich™ K-Force Case

This case provides a professional look, plus durability and easy care. Finish is weatherproof, scuff resistant, mildew free and maintenance free.

- K-Force™ material
- Belt slide design; fits belts up to 1¾"W

Black. Specify left or right hand

6R1-LP582 \$31.99



Gould and Goodrich™ K Force Cuff Case

Gould & Goodrich K-Force Cuff Cases provide a professional look. Plus, they are as durable as they are easy to care for, with a scuff-resistant and mildew-free finish.

- K-Force™ material (synthetic polymer laminate)
- Belt slide design; fits belts up to 1¾"W

Black

6R1-LP584 \$23.29



ASP® Snap-on Combo Case

Snaps onto your belt for convenience and added stability.

- Easy to put on and take off; stays in place when removing gear
- Holds ASP chain and hinged cuffs, plus most popular tactical flashlights or ASP batons
- Comes with hidden cuff key
- Fits belts up to 1¾"W
- Choose from ballistic nylon or plain synthetic leather finish

Snaps onto belt

6R1-LP639 \$42.39+

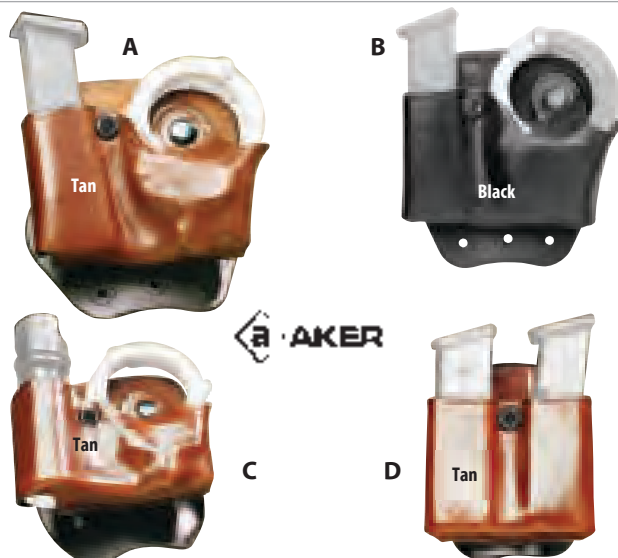

Aker® D.M.S. Series Cases

Aker D.M.S. Series gives you dual mount capability. For easy on/off, use the paddle mount. For more security and stability, use the belt slide mount.

- Fine molded leather; paddleback carriers with tension screw
- Fits belts up to 1¾"W
- Colors: LP345, LP350, and LP262 Tan and Black; LP476 Black only

Description	Holds	Item	Price
A) Magazine*/Handcuff	Double-stack mags and most standard chain or hinged cuffs	6R1-LP345	\$49.39
B) Magazine**/ASP® Handcuff	Double-stack mags and ASP® chain handcuffs	6R1-LP476	\$48.89
C) MK3 Mace®/Handcuff**	Canister of MK3 Mace and most standard chain or hinged cuffs	6R1-LP350	\$50.99
D) Twin Magazine**	Double-stack mags (Dual bars, reinforced with polymer)	6R1-LP262	\$39.99

* Specify make and model of weapon, right or left hand

** Specify right or left hand carry



Aker® Bikini Case for ASP Handcuffs

Bikini style cuff case clips onto 1¾" belts. Made in the USA. Black.

6R1-LP475 \$28.89



+ Visit us online for pricing on additional options.



Aker® Paddleback Single Handcuff Case

Paddleback design allows for fast on and off.

- Premium leather paddleback handcuff case
- Pull-through release snap
- Fits belts up to 1¾"W

6R1-LP233 \$33.39

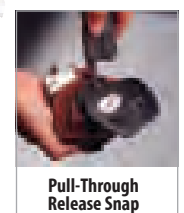
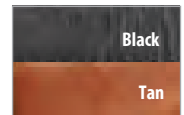

Pull-Through Release Snap

A Variety of Belts from Top Brands



Black



Tan



5.11 Tactical® TDU Belt with 1½" Plastic Buckle

An airport-friendly web belt with our patent-pending, non-metallic, low-profile buckle.

Sizes: S-4X, see size chart A on p. 98

6R1-NP569 starting at \$17.99+

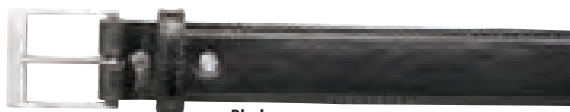
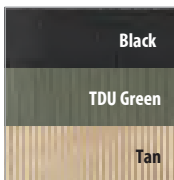

Black

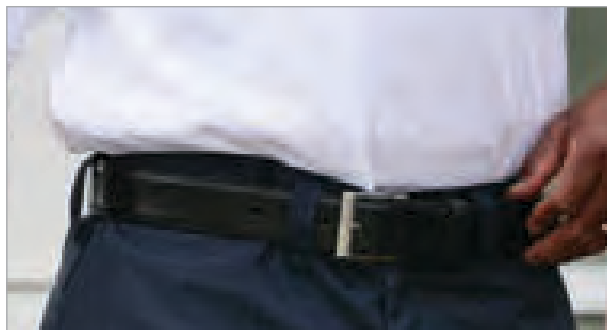

5.11 Tactical® Leather Casual Belt

5.11 Leather Casual Belts are made for everyday-casual, plainclothes or undercover wear.

- Full-grain leather with Permastiff™ insert to support weapon
- 1½" wide
- Buckle features "I-Beam" construction for rugged durability
- Black with nickel buckle or Brown with brass buckle
- Hidden key keeper on inside of belt
- Brown belts come with 5.11 branded brass plated buckle.
- Black belts include a nickel-plated buckle

Colors: Black, Brown. Sizes: S-4X, see size chart A on p. 98

6R1-LP537 starting at \$39.99+

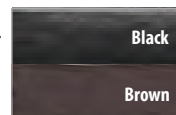

Galls® Leather Holster Belt

Supports the weight of your sidearm, handcuffs and extra magazine.

- Full-grain black leather with plastic/polymer internal stiffener
- Polyurethane lining
- Smooth rounded edge for added comfort
- Silver finished buckle

Colors: Black. Sizes: 30"-54" even

6R1-LH329 \$25.39



Tan

Gould & Goodrich™ Leather Trousers Belt

Double row top-stitching combined with top-grain leather and a solid brass buckle make this a durable dress belt for everyday wear.

1¼"W. Sizes: 30"-48" even

6R1-LP014 \$41.49

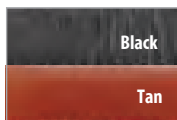

Tan with Brass

Aker® Reinforced Dress Belt

Premium leather belt designed for concealed carry. Features a polymer insert for maximum support.

1½"W. Sizes: 32"-46" even. Colors: Black with Nickel buckle and Tan with Brass buckle

6R1-LP224 \$44.49

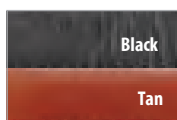

Gunner's Belt
Black



Arc Leather Belt

Brown

Ergonomically curved for all-day comfort

5.11 Tactical® Belts

Provides 1,500 lbs of tensile strength.

- Apex Gunner's Belt: 1½"W TPU coated B10 WEB
- Cast aluminum Type 3 anodized buckle with dual retention prongs for secure retention
- Arc Leather Belt: 1½" W, thick full-grain 4 mm durable matte leather

Colors: Black, Brown. Sizes: S-4X, see size chart A on p. 98

Description	Item	Price
Apex Gunner's Belt	6R1-LP856	\$59.99+
Arc Leather Belt	6R1-LP857	\$49.99+

That Provide a Casual or Formal Appearance

Starting at
\$13⁶⁹



LawPro® Garrison Belt

Durable top-grain leather construction.

- GSA approved
- 1½"W style fits virtually any style trouser, including khakis, tactical pants and uniform pants
- 1¾"W style provides extra strength and support for duty gear
- Removable silver nickel buckle

Made in the USA. Black. Sizes: Men's waist sizes 26-68 even.

Finishes: Basketweave and Plain

Finish	Width	Item	Starting at
Basketweave, Plain	1½"	6R1-LP006	\$13.69+
Basketweave, Plain	1¾"	6R1-LR136	\$15.79+
Hi-Gloss	1¾"	6R1-LR088	\$22.19+

+ Visit us online for pricing on additional options.

Shop more belts for tactical wear, starting on p. 340.

1½"W
Plain



1½"W
Basketweave

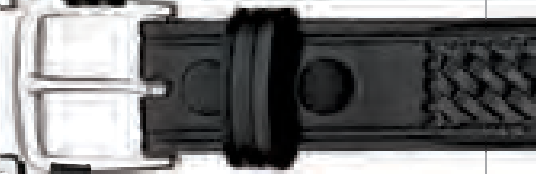

1¾"W
Plain



1¾"W
Basketweave



1¾"W
Hi-Gloss

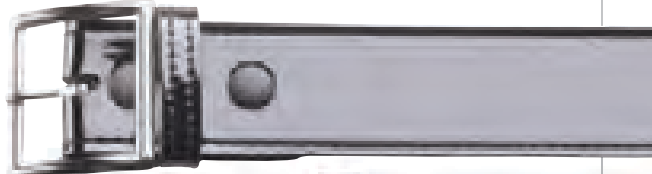

Basketweave



LawPro® Scratchless Leather Belt

Ideal for uniformed officers, mechanics, movers or anyone who wears a tool belt.

- Standard 1½"W leather belt
- Leather covered hidden 2-prong buckle keeps belt fastened

Made in the USA. SIZES: XS (24-26), S (28-32), M (34-38), L (40-44), XL (46-50), 2X (52-56), 3X (58-62), 4X (64-68)

6R1-LR090 \$23.39

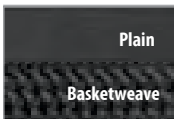

Plain

Basketweave

Plain
Black

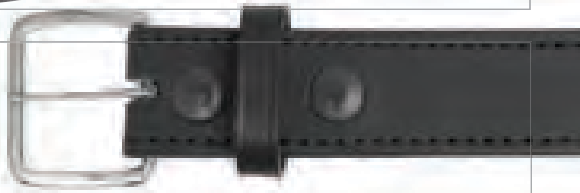

Basketweave
Black



Plain
Brown



LawPro® Premium Leather Uniform Belts

1½"W drum-dyed leather for superior color saturation.

- 12 oz top-grain leather
- Baked-in wax provides extra durability

Made in the USA. Sizes: Men's waist sizes 28-68 even

6R1-LR078

Plain Black	starting at \$21.39+
Plain Brown	starting at \$21.39+
Basketweave Black	starting at \$21.39+

VISIT US ONLINE



Find more belts for casual wear or concealed carry online at: galls.com/belts

Ultra-Small Recording Equipment



LEA

LAW ENFORCEMENT ASSOCIATES, INC.

LEA Scorpion Micro Digital Camera

Unique ultrasmall and compact design allows you to record in high resolution while subjects are unaware. Captures 2.0 megapixel images in low-light environments with high-speed recording and quick-light response.

- Supports AVI video format
- Manual audio recording
- Built-in rechargeable battery with a two-hour run-time
- Includes: 2GB SD micro card (expandable up to 16GB)

2 1/8" H x 7/8" W x 3/16" D

6R1-CA125 \$101.49

Waterproof Enclosure	6R1-CA127 \$29.99
8 GB Micro SDHC with USB Reader	6R1-CA128 \$36.59
16 GB Micro SDHC with USB Reader	6R1-CA129 \$145.19



Kit Contents: Micro Digital Video Recorder, Multi-Use Clip and Bracket, Micro SD Card, USB Cable AC Adapter, Storage Pouch, Protective Sleeve, Hook-and-Loop Fastener and Strap



Compact design for various recording situations

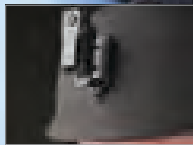

Includes various accessories for flexible mounting options



Can be used to review training scenarios

VISIT US ONLINE

See it, hear it, record it with wearable body cameras and dash cameras at: galls.com/cameras-surveillance-inspection

EARPHONE

Earphone Connection Mini DVR

Capture high resolution images discreetly with the Mini Digital Video Recorder. Officer-recorded video has been shown to reduce agency liability, improve officer safety and increase successful prosecutions when used as evidence.

- Pocket-sized alloy body construction
- 640 x 480 VGA resolution
- Built-in lithium battery recharges via USB
- Supports AVI video format and PC camera function
- Includes: all necessary software, 2GB SD micro card, USB charger, clothing clip and mounting brackets

6R1-CA133 \$70.99

8GB MicroSDHC with USB Reader	6R1-CA128 \$36.59
16GB MicroSDHC with USB Reader	6R1-CA129 \$145.19



Pocket sized for discrete recording



Includes accessories shown



PATROLEYES

NEW

Patrol Eyes Body Worn Cameras

Feature-packed body worn camera fits all budgets, with an organization system that allows you to quickly and efficiently locate evidence.

- Polymer construction
- 16-megapixel camera to capture while recording and burst shot options
- True 1080P HD to capture crystal clear wide-angle detail
- 140 degree wide angle field of view
- Extended battery life: 8 hours

3½"H x 2⅝"W x 1⅜"D". For additional features, visit galls.com

Description	Item	Price
16GB Model	6R1-CA084	\$299.95
32GB Model	6R1-CA085	\$349.95



Handsfree Operation

PRO-VISION
Video Systems

Pro Vision® BODYCAM™ HD Video Camera

Multifunctional camera is ideal for duty use with the capabilities to record in low-light conditions.

- IPX5 Waterproof Rating
- 1080P true HD video quality at 60 frames per second
- One-touch recording
- 8GB of built-in storage
- Built-in high-fidelity microphone
- 1½" LCD screen for viewing
- 170° field of view
- Micro HDMI and composite AV video output

2¾"H x 2"W x 1"D. For accessories and additional features, visit galls.com

6R1-CA014 \$299.99

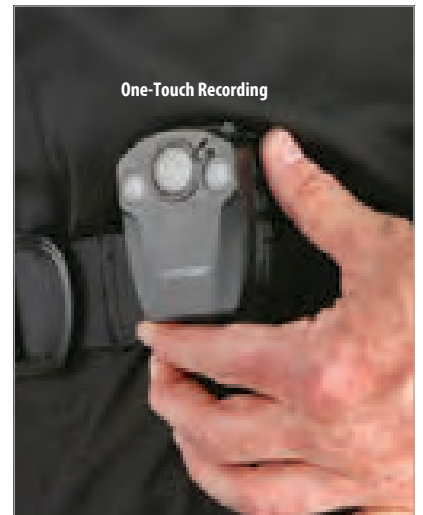

One-Touch Recording

VIEWU

VIEWU® Squared Body Worn Camera

Compact and wearable camera is easy to use with handsfree operation.

- Waterproof IPX5 rating
- Military-grade aluminum construction
- HD 1280x720 or SD 640x480 resolution
- 802.11 g/n live video streaming
- Recording time: 90 minutes (WiFi on), 150 minutes (WiFi off)
- 16GB internal storage
- 95° field of view
- VIEWU smartphone app lets you record, edit and share video
- Includes: camera, USB cable, anti-theft tag, spring clip and quick-start guide

2"H x 2"W x ¾"D. For accessories and additional features, visit galls.com

6R1-CA015 \$349.99

VIEWU Squared USB/RS232 Cable **6R1-CA020 \$39.99**



Lens cover slides to activate and deactivate recording



Compact and Wearable

Hi-Tech Solutions



WHISTLER

Rotate Image in Four Orientations

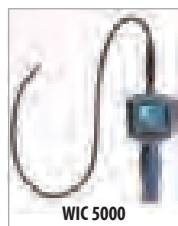

WIC 5000



WIC 5100

Whistler® Inspection Cameras

Compact and affordable, these easy-to-use inspection cameras let you see in hard-to-view places. Flexible camera is water, gas, diesel and oil proof.

- Can rotate the image in four orientations
- TV/video output jack connects the monitor to your TV or other display with a video cable for viewing and recording
- 3.3' flexible camera tube provides easy reach beyond arm's length
- Waterproof 9mm camera with LED lighting and 48° wide angle viewing lens that can fit into tight areas

WIC 5000: 2.4" color LCD monitor. Includes mirror, hook and magnet clip accessories for camera tube. 9¼" x 3½" x 1¼"

6R1-CA180 \$119.99

WIC 5100: 2.7" detachable color LCD monitor with anti-glare screen. Includes mirror, magnet and hook clip. 11½" x 14½" x 3½"

6R1-CA181 \$199.99

Flexible fiber optic tubes allow access behind walls and doors



WHISTLER

Whistler® Search and Inspection Camera

Lightweight, portable camera and inspection viewer allow a user to assess a situation without endangering officers. Flexible fiber optic tubes can slide under a door, around a corner, or into an attic to search for suspects or evidence.

- Aluminum housing is water, gas, diesel and oil proof
- 3½" detachable color LCD monitor with anti-glare screen
- Full video and image recording capabilities
- 33' wireless transmission range
- Internal rechargeable Li-Ion battery
- Perfect for evidence search, recovery, vehicle searches, breach, entry and searching behind walls

Black. Includes: 5½ mm and 9 mm camera tubes, battery charger and hard carrying case

6R1-CA136 \$411.69

3½' Extension Cable **6R1-CA137 \$33.19**



I-KAM XTREME

I-Kam 720P Video Glasses

Incorporates an advanced 720HD video into a lightweight pair of glasses.

- Features 1280x720P resolution and 63 degree field of view
- Up to 1.5 hours of recording
- Audio microphone captures sound
- Compatible with Windows Media Player
- 8GB internal memory and accepts 32GB micro SD card
- Impact-resistant polarized gray lenses

Includes USB cable, carrying case, cleaning cloth. 7.25" x 7.6" x 3.5", weighs .73lb

6R1-CA067 \$116.79

GoPro
Be a HERO.

GoPro® HERO4 Cameras

Introducing HERO4 editions, the most advanced GoPro ever. Featuring improved image quality and a powerful processor with faster video frame rates. HERO4 takes GoPro performance to the next level.

- 12MP Burst photos at a blistering 30 frames per second
- Protune™ settings for both photos and videos
- Night Photo and Night Lapse modes
- Built-in Wi-Fi and Bluetooth®

Watch this camera in action at galls.com

Silver Edition: Built-in touch display

6R1-CA029 \$399.99

Black Edition: Improved image quality, 2x more powerful processor and 2x faster video

6R1-CA028 \$499.99



Silver Edition



Black Edition



NVG Camera Mount

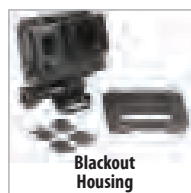

Blackout Housing



Handle Bar Seatpost Mount



Helmet Front Mount



Suction Cup Mount



Flat and Curved Mounts

GoPro® Accessories and Mounts

Description	Item	Price
NVG Camera Mount	6R1-CA026	\$29.99
Blackout Housing	6R1-CA025	\$49.99
Handle Bar Seatpost Mount	6R1-CA143	\$19.99
Helmet Front Mount	6R1-CA147	\$12.99
Suction Cup Mount	6R1-CA140	\$29.99
Flat and Curved Mounts	6R1-CA149	\$19.99

for Investigation and Surveillance

EO Tech X320 Compact Thermal Imager

Compact and easy to use, the X320 thermal imager is small enough to carry as standard equipment, yet rugged enough to hold up to field use.

- Simple one-button operation
- Greater scene detail with VGA 320 x 240 resolution
- Detects human activity up to 800 yards away
- Tripod mount (¼"-20 thread)
- Up to 6 hours runtime with 2 AA lithium batteries
- Includes USB cable, user interface software, lens cloth, neck/wrist straps and user manual

5½"H x 4½"W x 2"D. 13 oz

6R1-BN123 \$3,197.99



ATN GEN 2+ Night Vision Monocular

A hand-held or mounted system that enables activities in both moonlight and starlight. Ergonomic, simple, easy-to-operate controls.

- Compact, waterproof design
- Resolution: 40-45 lp/mm
- Weapon, head or helmet mountable
- Auto brightness control
- Operates on 1-CR123A lithium or 1-AA alkaline battery; adapter included
- Compatible with most IR lasers
- Total Darkness Technology with built-in Infrared illuminator and flood lens
- Optional patented Life Tracker System

4¾"x 2"x 2¾"

6R1-BN333 \$2,166.79



Night Optics D-930 Gen 3 Clip On Autogated Sight

The unique D-930 Sight attaches to the front of a variety of 1 to 20x daytime riflescopes to convert quickly to full night vision capability.

- Mounts in front of any 1-20x daytime scope
- No loss of zero
- Manual gain control
- Easily dismounts for daytime firing
- Integrated mount for IR illuminator
- Rugged and lightweight
- Adaptor for 40 and 50mm riflescopes
- Includes: 1-CR123 battery, operating manual, lens tissue

2¾"H x 7¾"W x 2⅞"D. 22 oz

6R1-BN476 \$6,124.99



MORO VISION NIGHT VISION LIGHT THE NIGHT™

Morovision™ Night Vision Dual-Tube Binocular

Extremely clear and crisp images under the darkest conditions.

- Fully submersible to 66 ft. (20 m)
- Can be easily detached to create two separate night monoculars
- Can be weapon mounted and camera/video adapted
- Includes integrated infrared illuminator
- Operates on 1 AA lithium battery
- Includes: MV-14P mini-monocular (2), dual bridge assembly, head-mount assembly, weapon mount and brow pads (S, M, L)

6R1-BN375 \$10,632.69



Powerful magnet for mounting inside or under a vehicle



Tracking Key



SilverCloud Real-Time GPS Tracker



Tracking Key Pro



LandAirSea Tracking Keys

Track a vehicle, validate driving routes and look for dangerous speeding violations with the LandAirSea Tracking Keys. This small GPS tracking device receives signals from 24 Department of Defense satellites orbiting the earth.

- Water-resistant ABS plastic housing
- Accurately determines its location within 2½ meters and records data every second
- Records and captures the complete movement history of a vehicle
- Displays location, date and time of every stop
- Powerful magnet for mounting inside or under a vehicle
- Includes a Past-Track® software for viewing the recorded data over a digital street map or satellite image via Google Earth

Tracking Key: Records more than 10 days of data. 3"H x 2"W x 1½"D

6R1-AP106 \$163.49

Tracking Key Pro: Records more than 60 days of data. 3¾"H x 1½"W x 1¾"D

6R1-AP105 \$217.99

LandAirSea SilverCloud Real-Time GPS Tracker

Track a vehicle's location, speed, direction, routes, addresses and distance with the Real-Time GPS Tracker. The receiver accurately determines its location within 2.5 meters and records data every three seconds.

- Water-resistant ABS plastic housing
- 3D tracking and historical playback
- Arrival and departure alerts (Geo-Fencing)
- Includes: tracking unit, USB wall charger, lithium ion battery and quick-start guide

Black. 4"L x 2¼"W x 1"H. **FREE** mobile phone app available. For more features and compatible software visit galls.com

6R1-AP107 \$359.99

AAA Batteries **6R1-FH216 \$18.99/4pk**

Exceptional Brightness and Clarity



Celestron® UpClose Binoculars

Perfect for stashing in your car or backpack, Celestron's UpClose binoculars are water resistant, compact, durable and versatile.

- Multi-coated optics increase light transmission, resulting in brighter and sharper images with high contrast levels
- Stylish rubber covered aluminum body protects from rough handling
- Ergonomic thumb indents and finger ridges for extra non-slip comfort and ease of use
- Water resistant
- Includes soft carrying case and strap



20 x 50

Description

Item	Price	
7-16 x 32	6R1-BN217	\$29.95
10 x 50	6R1-BN215	\$36.95
20 x 50	6R1-BN214	\$39.95
7-21 x 40	6R1-BN216	\$42.95
10-30 x 50	6R1-BN213	\$54.95



Galls® Porro Prism 10x50 Binoculars

Increase your field of depth with porro prism technology.

- Black rubberized
- BK-7 armor-coated optical lenses
- Material content: glass, ABS plastic, rubber and metal
- Normal coating, BK-7 Prism, full rubberize

Includes soft pouch, plain shoulder strap, lens cloth and instruction sheet

6R1-BN426 \$46.69

Tripod **6R1-BN453 \$13.19**



\$42⁹⁹



Bushnell® 10x50 PermaFocus Binoculars

With Bushnell® PermaFocus Binoculars, you never need to focus, no matter the distance.

- Fully coated optics
- Non-slip rubber armor
- BK-7 Porro Prism lenses
- Field of view (FOV) at 1000 yards is 393 feet

Includes case

6R1-BN329 \$90.39



NEW

Celestron® Nature DX 8 x 42 Binoculars

Feature-packed binoculars deliver fully multi-coated optics and BaK-4 prisms, while staying within your budget. Multi-coated optics provide brighter images, high resolution and high contrast views with enhanced color fidelity.

- Lightweight and durable rubber- armored polycarbonate housing
- Waterproof, fogproof and nitrogen purged
- High-quality BaK-4 prisms
- Multi-coated optics increase contrast and resolution for more detailed images
- Twist-up eyecups with multiple positions ensure comfortable viewing with or without glasses
- Wide field of view; 6.5' close focus for detailed, up-close observation
- Includes carrying case, lens cloth, neck strap, rainguard, objective lens caps and a limited lifetime warranty

6R1-BN201 \$139.95



Bushnell® Sport 850 Laser Rangefinder

Laser Rangefinder gives you the exact distance to your target.

- Pocket-size, lightweight ergonomic design with textured rubber grip
- 4x magnification
- Range of 5-850 yards
- BullsEye, Brush and Scan modes
- RainGuard® HD and built-in battery indicator
- Built-in tripod mount
- Rainproof housing
- Posi-lock battery cover

Includes: carrying case, battery and neck strap

6R1-BN448 \$263.89



Bushnell® H2O 12x25 Binoculars

BaK-4 Porro Prism lenses provide exceptional brightness and clarity.

- Durable rubber armoring
- Waterproof and fogproof
- Center focus and multi-coated optics
- Field of view at 1000 yards is 255 feet
- O-ring and nitrogen purge

Includes: carrying case and neck strap

6R1-BN071 \$76.19



Steiner® 8x22 Champ Binoculars

Compact binoculars provide top quality features and construction for optimal viewing.

- High-Contrast coatings on every lens ensure high performance and more comfortable viewing
- Fast-Close-Focus provides rapid focus and control, even as close as 10 feet
- Waterproof construction and rugged rubber armoring absorbs any bumps or abuse
- Ergonomic eyecups protect eyes from light obstruction
- Field of View: 332 ft

Includes: neck strap, cleaning cloth and padded case

6R1-BN067 \$99.99



Steiner® Optics for Surveillance



Steiner® Full-Size Police Binoculars

For reconnaissance missions that demand the capability of fast capture, the P830 model gives you a clear-cut lead.

- Floating Prism System with flexible silicon lens mount for shock and impact absorption
- Sports-Auto-Focus™ System; images retain clarity from 20 yards to infinity
- Cylindrical eyecups; objective cover, rain protection cap and carry case; neck strap

8x30 Binocular/P830 Model: Magnification of 8x. 4¼"H x 6¾"W x 2¼"L; 17.1 oz
6R1-BN138 \$229.99

7x50 Binocular/P750 Model: Magnification of 7x. 8¼"H x 5"W x 3"L; 36.3 oz
6R1-BN140 \$349.99

10x50 Binocular/P1050 Model: Magnification of 10x. 8¼"H x 5½"W x 2½"L; 35.3 oz
6R1-BN141 \$399.99



Steiner® Military 8x30r Binoculars with Reticle and Laser Range Finder

The M830r LRF model is built according to exacting military stipulations for unprecedented performance under pressure.

- Floating prism system with flexible silicon lens mount for shock and impact absorption
- Round-the-shoulder shape
- Sports-Auto-Focus™ System
- Makrolon® Housing rugged polycarbonate with NBR long life rubber armoring for a lightweight chassis that withstands 11 Gs of impact
- N2 Injection™ system for fog proof clearness; waterproof to 16 feet; pressurized nitrogen-filled tubes resist water interference even when immersed
- Cylindrical eyecups; objective cover, rain protection cap; neck strap
- Magnification of 8x; 4½"H x 6¾"W x 3"L; 26.5 oz



6R1-BN143 \$2,249.99

VISIT US ONLINE

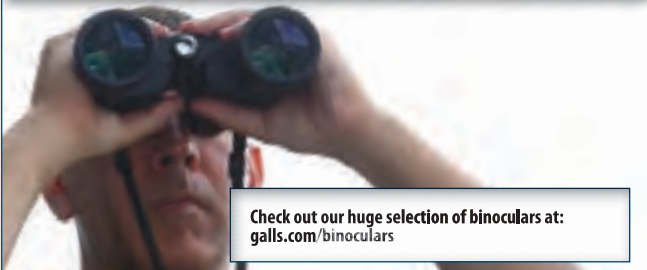

Check out our huge selection of binoculars at:
galls.com/binoculars

Steiner® Tactical Binoculars

Compact binoculars with crisp images and complex details, regardless of lighting, surroundings and distance.

- Specially coated high contrast optics
- Roof prism design
- Fast-Close-Focus™ for rapid and absolute clarity from close up to extreme distances
- Military-grade rubber armoring shields chassis and lenses, decreases noise and supplies a slip-proof grip
- ClicLoc® System for simple push-button operation
- N2 Injection™ system for fog proof clearness; waterproof to 6 feet submersion; ergonomic eyecups; objective cover, rain protection cap and gear bag
- Neoprene neck strap



T1042r Model

10x42 Binocular/T1042r Model:
 • SUMR targeting reticle system; magnification of 10x
 • 6½"H x 5"W x 2½"L; 26.4 oz [spec sheet says 26.7 oz]

6R1-BN145 \$649.99

8x24 Binocular/T824 Model:

- Magnification of 8x
- 4¾"H x 4¼"W x 2"L; 12.6 oz

6R1-BN144 \$269.99



T824 Model

Steiner® Compact Police Binoculars

Military-worthy polycarbonate construction, combined with waterproofing and fog proofing properties, empower the Police Binoculars to endure extreme impact, climates and moisture.

- Specially coated high contrast optics
- New gray NBR long life rubber armoring
- Slip-proof grip; waterproof and fog proof
- Makrolon® Housing rugged polycarbonate for a lightweight chassis that withstands 40 Gs of impact



P1026 Model

10x26 Binocular/P1026 Model: Compact roof prism design for lightweight transport.

- Sharp 3-dimensional image; Fast-Close-Focus™
- ClicLoc® System for simple push-button operation
- Ergonomic eyecups; carry case; magnification of 10x
- 4"H x 4"W x 1¾"L; 10.2 oz

6R1-BN136 \$169.99

10x42 Binocular/P1042 Model: Same features as the P1026 Model.

- Twist up ergonomic eyecups; objective cover, rain protection cap and carry case
- Magnification of 10x; 5¾"H x 5"W x 2½"L; 24.9 oz

6R1-BN137 \$329.99



P1042 Model

Intoximeters Inc.

Intoximeters Alco-Sensor Breathalyzer

The Alco-Sensor line of products offers instruments for both screening applications and applications where gathering court accepted evidence is required. These US DOT-approved testing instruments provide evidential accuracy and a quick-response time. Models include a carrying case and 25 mouthpieces.

Alco-Sensor III: Manually operated but accurate and economical method of determining a subject's breath/blood alcohol level.

- Includes last test recall
- Mouthpiece ejector
- Three-digit LED display
- Comes with calibration tool

5"H x 3½"W x 1¼"D. 6 oz

6R1-LE906 \$525.00

9V Batteries **6R1-FH210 \$11.99/2 pk**

Disposable Mouthpieces **6R1-LE908 \$66.99/250 pk**

Alco-Sensor IV: Automated, software-driven test protocol. Each function is displayed on an LED pane, which provides the operator step by step instructions for fail-safe testing. It can be connected to and run with a printer microprocessor or a computer for additional storage. The black dot saves up to 84 tests in the unit while the green dot model has one last test recall.

- One-way auto-eject mouthpiece
- Menu-driven test procedure
- Breath sampling indicator; automatic and manual sampling
- Four-digit, alpha-numeric LED display for easy viewing
- Uses single 9V battery (sold separately)
- Includes: calibration tool

5¼"H x 3½"W x 1½"D. 9 oz

Description

	Item	Price
Green Dot	6R1-LW020	\$744.99
Black Dot with Memory	6R1-LW021	\$831.99

9V Batteries **6R1-FH210 \$11.99/2 pk**

Disposable Mouthpieces **6R1-LW022 \$30.99/100 pk**

Alco-Sensor V: Advanced hand-held, microprocessor driven, alcohol testing instrument. The symmetrical design allows the operator to remain in control of the subject, view the display and monitor the surroundings. It saves up to 7,000 tests in the unit.

- Breath sampling indicator; automatic and manual sampling
- Multi-color, backlit, graphics, LCD display
- Uses 4 AA batteries (sold separately)

7¾"H x 2¼"W x 4¾"D. 12 oz

6R1-LW068 \$831.99

AA Batteries **6R1-FH207 \$4.99/2 pk**

Disposable Mouthpieces **6R1-LW096 \$66.99/250 pk**



Alco-Sensor III



Comes with carrying case and mouthpieces



Alco-Sensor IV



Comes with carrying case and mouthpieces



Four-Digit, Alpha-Numeric LED Display



Alco-Sensor V

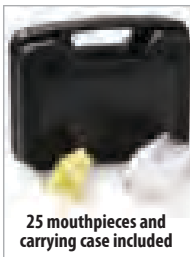

25 mouthpieces and carrying case included

Intoximeters Inc.

Intoximeters Alco-Sensor FST

Subject's breath exits safely away from operator. Back-facing display allows operator to observe subject, instrument and traffic at the same time.

- NHTSA, U.S. DOT-approved
- Fast, accurate readings in 5-10 seconds
- Self-aligning mouthpiece attaches quickly
- Automatic breath sampling eliminates operator errors to ensure consistent, precise test results
- Passive test sampling from a subject or open container
- Integrated calibration procedure ensures accurate adjustments
- Uses 2 AA batteries (sold separately)
- Includes: carrying case, rubberized grip, display bezel and lens protector, wrist strap, web-based training, 25 mouthpieces, 2 passive cups and 1 sniffer adapter

4¾"H x 1¾"W x 2¾"D. 6 oz

6R1-LE905 \$555.00

AA Batteries **6R1-FH207 \$4.99/2 pk**

Disposable Mouthpieces **6R1-LE907 \$66.99/250 pk**



CMI AlcoBlow® Alcohol Breath Tester

Active mode lets subject blow into the cone where a sample of breath is collected for analysis.

Passive mode doesn't even require the subject's cooperation.

- Displays response, result and reset readings in just seconds
- Just wipe with alcohol-free AlcoBlow® towelettes (sold separately below)
- Includes: 4 AA batteries

2"H x 10½"W x 2"D. 10.5 oz

6R1-LE309 \$507.49

AA Batteries **6R1-FH207 \$19.99/16 pk**

AlcoBlow® Towelettes **6R1-LE310 \$18.49/100 pk**



Practical and Portable Evidence Collection

SIRCHIE®



SIRCHIE® Porelon Compact Fingerprinting Kit

The ideal choice whenever maximum portability is required. Kit includes:

- 1 injection molded fingerprint cardholder
- 20 super clean towelettes
- 1 Porelon® fingerprint pad
- Polypropylene accessory case
- Copolymer black molded carry case

6¼"H x 13¼"W x 15½"D

6R1-LE266 \$121.29

Replacement Pad **6R1-LE139 \$16.49**

nik®

NIK® Narcotics ID Porta-Pac

The Porta-Pac® Drug Kit is recommended for narcotics identification operations where portability and ease-of-use are prime considerations. Notebook-sized kit fits any briefcase or zip brief.

Tests presumptively identify 25 different controlled substances, including opiates, barbiturates, LSD, marijuana, cocaine/crack, methadone, PCP and brown heroin.

- Disposable test packs are self-contained with step-by-step instructions
- No mixing, measuring or dispensing required
- Color-coded for quick visual results
- Tests for most known and frequently used drugs
- Contains 24 tests, including Acid Neutralizer Test F, as well as polytesting instructions, polytesting report pad and IDENTIDRUG™ Chart

14"H x 10"W x 3"D. Refills are available online

6R1-LE049 \$128.79

nik®

NIK® Master Pac® Drug Kit

The Master Pac Drug Kit allows for accurate identification of cocaine, marijuana, heroin and other drugs. Perform up to 130 tests from this one handy kit. Includes:

- Durable polystyrene carrying case
- Box of acid neutralizer
- Report pad
- Testing instruction manual
- Full-color identification chart
- Training CD

14"H x 12"W x 5"D

6R1-LE087 \$422.69



SIRCHIE®

SIRCHIE® II Latent Print Kit

The most complete compact latent print field kit.

6R1-LE135 \$111.19



SIRCHIE® II Kit Contents:

- | | |
|---|--|
| 1 Silk Black Latent Powder (2 oz) | 2 Black Rubber Lifters (2"H x 4"W) |
| 1 Silver/Gray Latent Powder (2 oz) | 1 Porelon® Pad |
| 1 Indestructible White Latent Powder (2 oz) | 1 Wallet Type Vinyl Case |
| 3 Fiberglass Latent Print Brushes | 1 Elimination Form Pad (50 sheets) |
| 24 Transparent Hinge Lifters (1½"H x 2"W) | 1 Attached Case Magnifier (1¼" in diameter) |
| 12 Black Hinge Lifters (1½"H x 2"W) | 1 Evidence Tape (1"W x 500"L) |
| 12 White Hinge Lifters (1½"H x 2"W) | 6 Evidence Bags (4"H x 9"W) |
| 6 Transparent Hinge Lifters (2"H x 4"W) | 9 Ink Cleaner Towelettes |
| 6 Black Hinge Lifters (2"H x 4"W) | 1 Carrying Case with Compartments (6½"H x 8¼"W x 7¼"D) |
| 6 White Hinge Lifters (2"H x 4"W) | |
| 2 White Rubber Lifters (2"H x 4"W) | |

SIRCHIE®

SIRCHIE® Scott Latent Print Kit

Ideal for departments handling a wide range of crime scene situations. Offers an increased selection of fingerprint powders and lifters.

6R1-LE133 \$81.19



SIRCHIE® Scott Kit Contents:

- | | |
|---|---|
| 1 Silk Black Latent Powder (2 oz) | 2 Black Rubber Lifters |
| 1 Indestructible White Latent Powder (2 oz) | 1 Scissors (5"L) |
| 1 Silver/Gray Powder (2 oz) | 2 Disposable Gloves |
| 3 Regular Powder Brushes | 1 Attached Case Magnifier (1¼" in diameter) |
| 24 Transparent Hinge Lifters (1½"H x 2"W) | 6 Evidence Labels |
| 12 White Hinge Lifters (1½"H x 2"W) | 6 Evidence Bags (4"H x 6"W) |
| 12 Black Hinge Lifters (1½"H x 2"W) | 1 Black Leather Case (3⅞"H x 9⅞"W x 6¾"D) |
| 2 White Rubber Lifters (2"H x 4"W) | |

SIRCHIE®

SIRCHIE® Patrol Latent Print Kit

Case is made of ABS plastic and includes the following:

6R1-LE132 \$27.99

SIRCHIE® Patrol Kit Contents:

- | | |
|-----------------------------------|--|
| 1 Silk Black Latent Powder (2 oz) | 2 Disposable Gloves |
| 1 Fiberglass Brush | 1 Backing Sheet Pad (3"H x 5"W, 50 sheets) |
| 1 Lifting Tape Roll (2"W x 360"L) | 1 ABS Plastic Carrying Case (6¾"H x 7¼"W x 3⅞"D) |



Pinpoint Threats with Precision



GARRETT

Garrett® Super Scanner V Portable Metal Detector

This Super Scanner now comes with visual, audible and silent vibrating alarms. Meets current *NIJ602.02 specs* which call for on light (Green), low battery light (Amber) and visible-audible alarm light (Red).

- Detects metal objects as small as a coin, no tuning required
- Thermoplastic handle, secure grip and convenient wrist strap
- 3 LED lights: Green, Amber, Red
- 100 hours continuous operation
- Optional Earplug mutes warning signal sounds
- Optional Recharger Kit features charger and battery
- Includes: 9V battery

16"L. 18 oz

6R1-AP010 \$152.99

Earplug **6R1-AP056 \$3.99**
 9V Batteries **6R1-FH210 \$11.99/2 pk**
 Recharger Kit **6R1-AP077 \$25.99**



GARRETT

Garrett® CSI Pro All-Terrain Metal Detector

All terrain versatility for recovering metallic evidence at a crime scene.

- High-Res Iron Discrimination™
- 40 levels with adjustability to help eliminate trash items
- Digital target ID with an enhanced 0-to-99 target ID scale
- Identify multiple targets in close proximity
- Includes: Garrett deluxe headphones, tactical travel/storage case, CSI Pro-Pointer™ pinpointer, plus a training DVD and manual

6R1-LW252 \$978.99



FISHER RESEARCH LABS

Fisher® Labs CW 10 Handheld Metal Detector

Designed for stand-alone use or in conjunction with the Fisher M-Scope Walk-Through Detector. Operates at a high frequency of 110 kHz to detect ferrous and non-ferrous metals without tuning.

- Polymer construction for durability; 3-position switch for power, audio and vibrate
- Sensitivity setting at optimum level; audio and silent vibrator alarm modes
- Red and green LED light indicator; low battery indicator
- 2700 Hz audio frequency, 110 kHz operating frequency; includes 1 9V battery
- Operates at temperatures 0°F to 160°F
- 15¾"L; 11.2 oz; made in the USA

6R1-AP091 \$124.99

GALLS



Galls® Hand-Held Metal Detector

Made for Galls by Garrett, this tough, compact detector emits vibration as well as a visible Red LED alert light.

- High-impact ABS plastic
- Green light indicator for on, Red light and vibration for metal objects, and Amber light for low battery
- Non-rolling tough grip prevents slipping and rolling while wearing gloves
- Comes with ballistic weave belt holster and hook-and-loop material for vehicle mounting
- Includes: 9V battery

Made in the USA. 8½"L. 6 oz

6R1-AP318 \$178.49

9V Batteries **6R1-FH210 \$11.99/2 pk**



White LED brightens dark areas

GARRETT

Garrett® Super Wand Hand-Held Metal Detector

Sleek, slender design delivers precise 360° detection capability with one-touch operation.

- 3 color LED display
- Optimum sensitivity
- Automatic retuning
- Audible or silent vibrating signal
- Operates on a 9V battery (not included)

19"L. 16 oz

6R1-AP001 \$197.89

9V Batteries **6R1-FH210 \$11.99/2 pk**

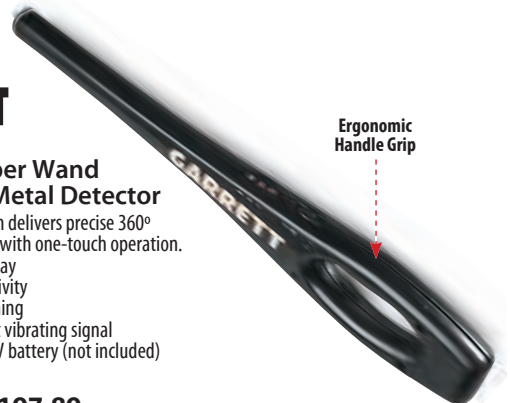

Ergonomic Handle Grip

No Hassle Guarantee

See p. 98

VISIT US ONLINE

Shop our assortment of portable and permanent metal detectors at:
galls.com/metal-detectors

Protect Crowds with Confidence

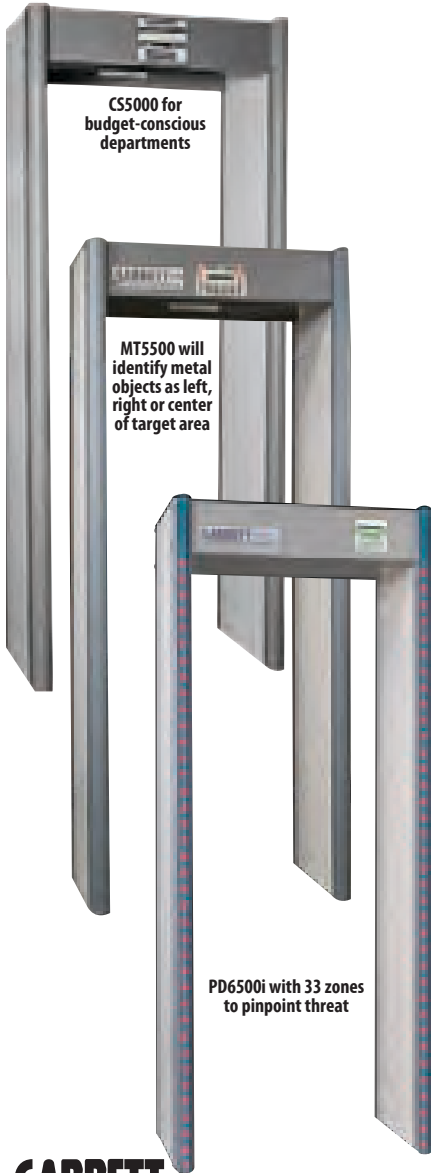

GARRETT

Garrett® Magnascanners

Unique multi-dimension coil design and easy-to-interpret alarm displays provide an ultimate precision target locator.

- 6 zone detectors
- Uniform detection reduces false alarm
- Pinpoint Detection™ locates target whether left, center or right side of body head-to-toe
- Entrance side pacing lights cue patrons to pass through detector or wait until it is ready
- Audible and visual alarms
- Multi-coil design reduces susceptibility to outside interference, assuring precise detection regardless of target location or orientation

For more information visit galls.com

Model	Item	Price
CS5000	6R1-AP057	\$4,495.00
MT5500	6R1-AP092	\$4,495.00
PD6500i	6R1-AP140	\$5,495.00

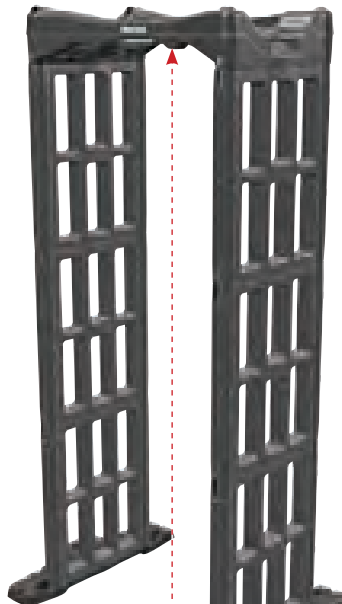

FISHER RESEARCH LABS



37"H x 23"W x 26"D
Collapsed Unit

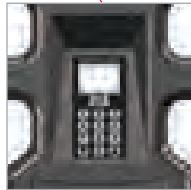

Digital Keypad with Security Access Control

Fisher® Labs M-Scope Walk-Through Metal Detector

Portable or permanent modular design, walk-through metal detector. Can be set up or taken down in only five minutes.

- FAA, NIJECJ-0601.00 and EMC (CE) compliant
- Single person portability
- Digital keypad with security access control
- 40-hour rechargeable batteries
- Adjustable to 100 varying levels of sensitivity
- Head-to-toe zone specific detection
- Includes: AC adapter

6R1-AP401 \$4,348.29

FREE Hand-Held Detector

with purchase of M-Scope Metal Detector.

A \$124.99 value!



We offer the technology your job demands in a huge selection of flashlights, batteries and chargers, starting on p. 188.



GALLS®

Handle design reduces stress on wrist

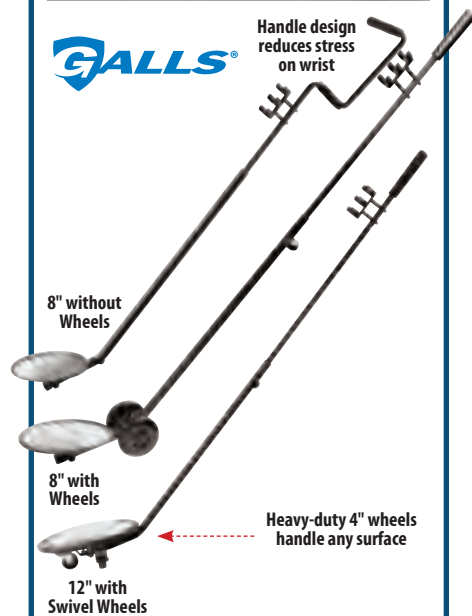

Galls® Under-Carriage Inspection Mirrors

Inspect under vehicles with lightweight, budget-friendly mirrors. Mirrors available with and without wheels.

- Convex mirror
- Telescopic handle with padded grip adjusts from 37" to 51"
- Adjustable bracket on handle to hold D-cell flashlight

12" Mirror: 6 lb. 8" Mirror with wheels: 4 lb. 8" Mirror without wheels: 3 lb

Description	Item	Price
8" w/out Wheels	6R1-LE783	\$97.99
8" w/Wheels	6R1-LE527	\$125.79
12" w/Swivel Wheels	6R1-LE054	\$131.19
8" Replacement Mirror	6R1-LE057	\$24.99
12" Replacement Mirror	6R1-LE485	\$41.39

Chain-Style Restraints

NEW



Lightweight, Forged Aluminum Strength

EXCLUSIVE ITEMS

ASP® Ultra Handcuffs

The first forged-aluminum rigid-frame restraint. Overmolded with ordinance-grade polymers making it stronger and up to 30% lighter than other handcuffs.

- Steel or aluminum contact bow with highly radiused edges
- Stainless steel chain with reinforced swivel
- Beveled keyway and double lock slot on each side
- Double and single locks are released by turning the key in a single direction

Black. 7 oz (Aluminum), 9 oz (Steel)

Description	Item	Price
Aluminum	6E2-RS261	\$45.99
Steel	6E2-RS267	\$49.99



ASP® Chain-Style Handcuffs

Over-molded cuff with tactical advantages, including:

- Dual-beveled keyway on both sides for continuous accessibility
- Flat, high-contact bow section provides a secure single-movement application, preventing slippage on wrist
- Smooth action engagement of locking bar to tooth bow in all 22 positions, making back-loading unnecessary
- Bright yellow warning indicator light alerts you to double lock the cuffs before transporting your subject
- Uses a standard handcuff key (sold separately)

Stainless Steel: 9 oz. Aluminum: 7 oz

Stainless Steel	6R1-RS164	
Black	6R1-RS169	\$40.19
6 colors		\$46.49
Black Aluminum	6R1-RS190	\$49.99

Note: Does not fit in standard cuff case

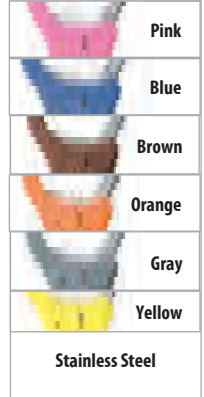

PEERLESS®

Peerless® Standard Handcuffs

Raised rivet design improves strength and reliability.

- Steel construction
- Heat-treated chain for durability
- Double-locking system
- 19 locking positions

Includes 2 keys. 10 oz

Description	Finish	Item	Price
Model 700	Nickel	6R1-RS001	\$26.39
Model 700B	Black Oxide	6R1-RS003	\$26.39
Model 750	Colors	6R1-RS225	\$40.49

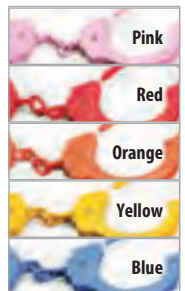

for Proven Reliability



Standard

Starting at
\$19⁹⁹

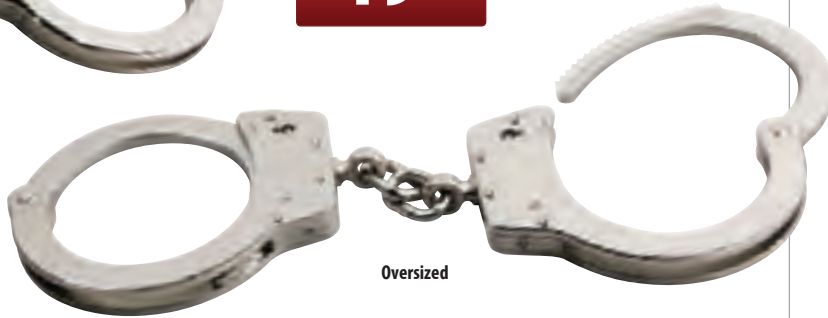

Oversized



Galls® Handcuffs

Galls double-locking handcuffs are perfect for budget-conscious officers and departments.

- Steel construction
- Heat-treated chain for durability

Nickel-plated finish. Includes 1 key

Desc.	Locking Positions	Weight	Item	Price
Standard	19	10 oz	6R1-RS034	\$19.99
Oversized	23	11 oz	6R1-RS050	\$36.29



Smith & Wesson® Model #100 Handcuffs

Common features include: high carbon and nickel-plated steel construction with 2 keys.

Traditional Style: 23 locking positions and double-locking pin. Nickel finish. 10 oz.
6R1-RS021 \$23.99

Blue Steel: Discreet, no-glare finish. 20 locking positions. Double-lock engaging pin ensures security. 10 oz.

6R1-RS047 \$24.99

Pushpin Double Lock: 23 locking positions. Pushpin double lock. 12 oz.
6R1-RS133 \$26.99

M&P Lever Lock: Innovative Lever Lock cuffs engage the double lock with just a flip of a lever. When applied to suspect, the lever moves away from the direction you're cuffing, so it won't accidentally engage. 10 oz.

6R1-RS223 \$29.99

Bulk Order Savings

We can offer major discounts for high quantity orders. Call 800.477.7766 with your specifications, and we'll work to give you the best discount.



Flip a lever to engage double-lock feature



Smith & Wesson® Model #110 Oversized Handcuffs

Oversized for those with larger than average wrists. Hi-carbon, steel construction. 24 locking positions. Includes 2 keys. Nickel-plated finish. 16 oz.

6R1-RS143 \$39.99



Hiatt® Standard Handcuffs

Meets *NIJ Standard 0307.01* standards. Steel construction with a heat-treated chain. A double-locking pin engages 20 locking positions. Nickel-plated finish. Includes 2 keys. 10.5 oz

6R1-RS038 \$32.29

Increase Security & Control with Hinged Cuffs



Galls® Hinged Handcuffs

Passed a 200 kgf pulling test. Restricts movement in hands and wrists.

- 420 stainless steel construction
- Double-bar hinges
- Double-locking system
- 21 locking positions

Nickel-plated finish. Includes 2 keys. 11 oz

6R1-RS082 \$32.99

Satin



Black



Smith & Wesson®

Smith & Wesson® Model #300 Hinged Handcuffs

Double-lock configuration and hinged design increase security.

- Meets *NIJ Standard 0307.01*
- Carbon steel construction
- 23 locking positions

Includes 2 keys. 11 oz

Description	Item	Price
Satin	6R1-RS012	\$29.99
Blue	6R1-RS108	\$35.99

PEERLESS®



Peerless® Model #801C Nickel Hinged Handcuffs

Provides better restraint than standard cuffs. Incorporates a raised rivet design, improving strength and reliability.

- Hi-carbon, steel construction
- Double-hinged design and 22 locking positions
- Double-lock engaging pin

Nickel-plated finish. Includes 2 keys. 16 oz

6R1-RS005 \$35.59



Peerless® Model #801C Black Hinged Handcuffs

Incorporates a raised rivet design, improving strength and reliability.

- Carbon steel construction
- 19 locking positions

Black oxide finish. Includes 2 keys. 12 oz

6R1-RS006 \$40.59



Hiatt® Standard Hinged Handcuff

Eighteen teeth make these cuffs hard to pick and provide increased strength.

- *NIJ Standard 0307.01*
- True Swing Technology is balanced and centered, so it locks at the center point
- Domed rivets are bigger on the outside, making it difficult to drill open
- Double-lock configuration

Nickel-plated finish. Includes 2 keys. 12.8 oz

6R1-RS011 \$54.59



Smith & Wesson®



Smith & Wesson® Universal Hinged Handcuffs

Universal hinged cuffs open 25% larger and close 25% smaller than standard cuffs.

- Carbon steel construction
- Pushpin double-locking mechanism
- Double-lock configuration

Satin nickel finish. 12 oz

6R1-RS109 \$48.99



Automatically locks rigid



Steel



Aluminum

ASP® Rigid Handcuffs

Extension lock design ensures a secure cuff, permitting firm control over the most resistive subject.

- Automatically locks open
- Removes both lateral and linear ability
- Orientation disks confirm proper positioning

Steel: 12.8 oz. Aluminum: 10.7 oz

Description	Item	Price
Steel	6R1-RS202	\$80.39
Aluminum	6R1-RS203	\$90.19

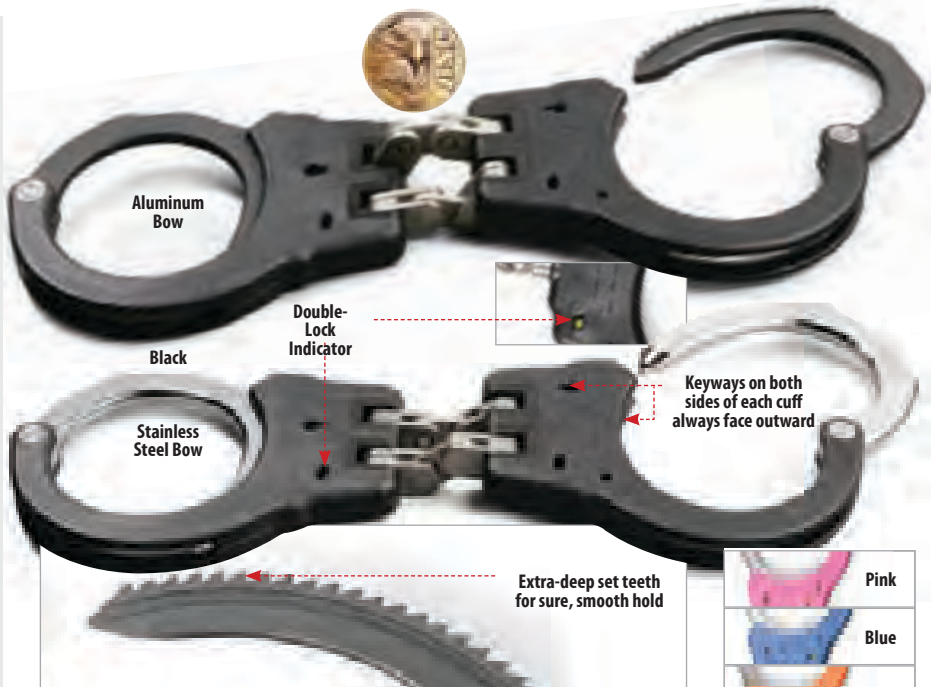

ASP® Hinge-Style Handcuffs

Tactical advantages make these the cuffs of choice for active professionals.

Color	Bow Finish	Weight	Item	Price
Black	Stainless Steel	9 oz	6R1-RS183	\$50.89
Available in all 6 colors	Stainless Steel	9 oz	6R1-RS189	\$57.99
Black	Aluminum	7 oz	6R1-RS191	\$60.69

Over 45 Years in Service

We are dedicated to serving our customers with quality products, customized services and quick deliveries. Call 800.477.7766 today to learn more.

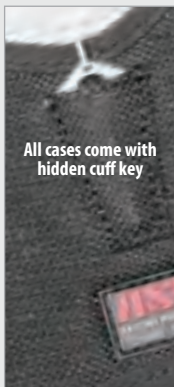
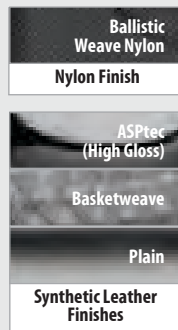

All cases come with hidden cuff key

ASP® Closed Top Cases have a flap that prevents grabs, protects, and covers both chain and hinge style handcuffs.

ASP® Investigator Cases provide a low-profile, pull-through carrier for both chain and hinge style handcuffs.

ASP® Open Top Cases offer visibility and easy access to cuffs for both chain and hinge style handcuffs.

ASP® Combo Cases snaps onto your belt for convenience and added stability.



ASP® Chain and Hinged Handcuff Cases

All hold one pair of handcuffs and have snap closures. Hidden cuff key pocket on back of case with key.

Description	Ballistic Weave Nylon	Synthetic Leather*	Item
Single Closed Top	\$29.49	—	6R1-NP529
Single Closed Top**	—	\$34.99+	6R1-LP525
Investigator	\$33.99	\$40.29	6R1-LP565
Open Top	\$29.49	\$35.99+	6R1-LP567
Double Closed Top	\$35.99	\$39.99+	6R1-LP638
Combo Case	\$42.39	\$48.99	6R1-LP639

*Specify ASPtec (High Gloss), Basketweave (BW) or Plain (PL) **Fits chained, hinged and rigid cuffs

[+](#) Visit us online for pricing on additional options.

Restrict Mobility for Secure Transport



Galls® Double Lock Leg Irons

Restrict your prisoner's stride with double-locking leg irons.

- Nickel-plated steel construction
- 22 locking positions
- Standard size: Inner perimeter measures 7¾" to 10"
- Oversized: Inner perimeter measures 9½" to 10½"

Includes 1 key

Desc.	Weight	Chain Length	Item	Price
Standard	20 oz	15"	6R1-RS036	\$36.29
Oversized	17 oz	14"	6R1-RS051	\$42.69



Smith & Wesson®



Smith & Wesson® Model #1900 Leg Irons

Secures and restrains with nickel-finished steel construction.

- 14" heat-treated chain
- 22 locking positions. 21 oz

6R1-RS024 \$44.99

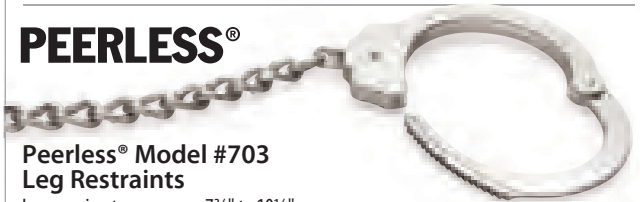

PEERLESS®

Peerless® Model #703 Leg Restraints

Inner perimeter measures 7¾" to 10¼".

- Nickel-plated steel with a 15" heat-treated steel chain
- 20 locking positions
- Includes 2 keys. 20 oz

6R1-RS007 \$57.89



Peerless® Model #705 Oversized Leg Irons

Inner perimeter measures 9¼" to 10¼".

- Nickel-plated steel with a 15" heat-treated steel chain
- 25 locking positions
- Includes 2 keys. 17 oz

6R1-RS008 \$142.99

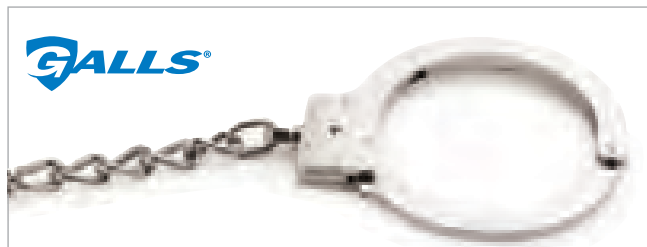

Galls® Oversized Boot Cuff and Leg Iron

Largest opening boot cuff with a 5½" open diameter and a 3½" smallest closed diameter. Constructed of heat-treated carbon steel, nickel-plated. 30 teeth ratchet with 15" chain. Overall 27¼". Double-locking mechanism. 30 oz.

6R1-RS138 \$71.49



CTS™ Thompson Blue Box

Blue Box covers keyholes, making chain cuffs rigid. Compatible with both handcuffs and leg irons!

- Steel construction
- Prevents prisoners from using a shim or pick
- Double lock is accessible from slots on the side
- Can be padlocked and used with belly chain
- 6 oz

6R1-RS293 \$28.89

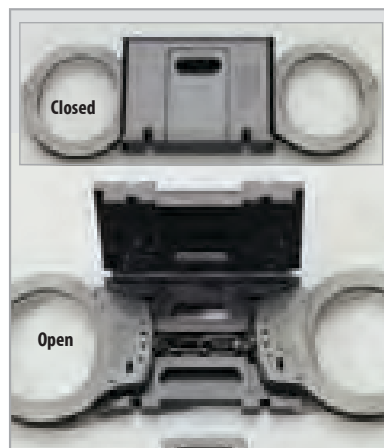

Galls® Training Handcuffs

These modified steel training handcuffs will fit in a standard cuff case for realistic training role play. Works as either single or double lock. Engraved with "TRAINING HANDCUFFS ONLY".

6R1-TN047 \$47.99

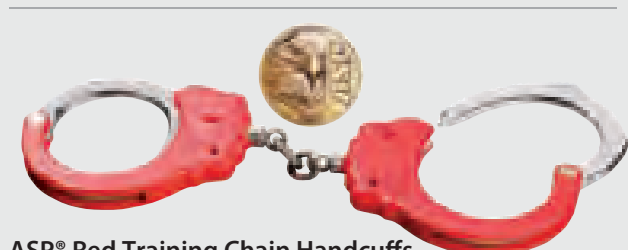

ASP® Red Training Chain Handcuffs

These training cuffs open just by rotating wrists, making it easier to practice your technique again and again. Steel with polymer coated finish. Double-lock feature for advanced training. Includes cuff key. 9 oz.

6R1-TN183 \$48.99



Disposable

Training

Double lock is quick and easy to activate, providing extra-firm hold

Cobra Cuffs®

These super-tough restraints are the only disposable cuffs that feature a double-locking mechanism! Get the reusable training model to guarantee that you are always ready to use your Cobra Cuffs.

- UV-resistant engineered polymer construction
- Riveted straps with double lock
- Assembled tensile strength of over 250 lbs

Description	Item	Price
Training	6R1-RS292	\$20.69/3 pk
Disposable	6R1-RS299	\$23.29/6 pk
Disposable	6R1-RS291	\$326.19/100 pk

ASP® Tri-Fold Disposable Restraints

Plastic restraints slip over prisoner's wrists easily and quickly without fumbling.

- Oversized loops of incredible tensile strength are foldable
- Double cuff means no hooking two straps together
- Locking block is pick resistant
- 2 ID strips for writing prisoner info
- All Tri-Fold 6-packs come with EZ Pull Ring (sold separately below)

Colors: Black and Yellow

6R1-RS145 \$21.49/6 pk

Tri-Fold Reusable Training Restraints

6R1-RS147 \$21.49/6 pk

Tri-Fold Pull Tabs 6R1-RS149 \$10.79/6 pk



Black



Roller Loc™ ratchet has smooth pull and covered locking mechanism



Reusable Training Restraints



Cuts restraints like a hot knife cuts through butter



ASP® SCARAB Restraint Cutter

Compact, folding, easily carried, lightweight cutter is specifically designed for removing disposable restraints.

- Cannot injure suspects and cannot be used as a weapon against you
- Uses compound leverage to safely remove restraints
- Easily carried in a uniform pocket or snapped onto a key ring or tactical bag

3"H x 1 3/8"W x 1/4"D. 6 oz

6R1-RS091 \$24.99

Bulk Order Savings

We can offer major discounts for high quantity orders. Call 800.477.7766 with your specifications, and we'll work to give you the best discount.



White

MONADNOCK®

Monadnock® Disposable Double Cuff Packs

Using standard cuffing techniques, one of these 1/2" wide disposable double cuffs from Monadnock will do the job of two single-strap disposables. Cuffs have 400-lb tensile strength and will not cut into prisoner's wrists. All nylon cuffs can also be written on.

Colors	Item	Price
Black, White	6R1-RS068	\$32.19/10 pk
Black, White	6R1-RS069	\$177.69+/100 pk

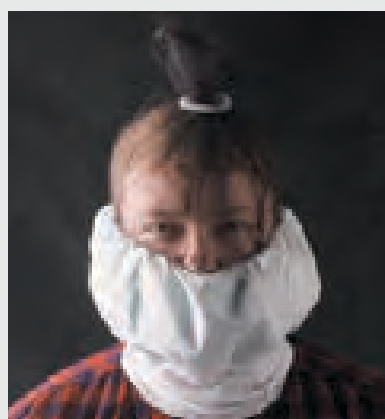

Tranzport Hood

Made with layered bacteria-filtering surgical mask medical fabric to contain airborne and bloodborne contaminants. Easy on/off, there's no front, back, straps or fasteners. Hood draws in under eye and chin areas and covers entire circumference of head.

6R1-RS086 \$54.59/5 pk

GALLS®

\$11.59



Galls® Cuff Cutters

Easily cuts all disposable cuffs.

- Rubber handles prevent slipping
- Lock keeps the blade closed when not in use

2 1/2"W x 5 1/4"L. 2.7 oz

6R1-RS233 \$12.59

We Accept these Major Credit Cards



Ordering online? Use your PROMOTIONAL CODE from the back cover

800.477.7766 • galls.com

323

Limit Range of Movement with Restraint Belts



Gould & Goodrich™ Double Ply Restraint Belt

Safely secures behind the prisoner with a sturdy steel buckle.

- Heavy-duty reinforced nylon
- Heavy steel D-ring to secure handcuffs in front of the prisoner
- Fits waists between 28"-54"

Black. Made in the USA. 2"W

6R1-RS092 \$58.79



Gould & Goodrich™ Nylon Hobble Restraint

Added security for transporting suspects in an upright position.

- Heavy-duty nylon web
- Snap hook on one end and a permanent, self-locking alligator clip on the other end

Black. Made in the USA. One size fits most. 48"L x 1"W

6R1-RS093 \$20.69

Helps prevent subject from kicking doors or windows



ASP® S1 Swivel Handcuff key

Strong and dependable, with the strength to hold up to years of service.

- Made of heat treated stainless steel
- Chrome plated with a textured grip
- Patented backset tooth allows rapid location of the key way
- Swivel key ring attachment
- Double lock pin is inset into the key body
- Textured for secure grip even when wet
- Weighs 0.32 oz

6R1-RS262 \$14.29



ASP® AutoKey

Sleek and simple, the AutoKey is small enough for convenient carry and strong enough for every day use.

- Automatic, push-button operation
- Heat-treated stainless steel key
- Polymer body
- Double lock pin deploys with manually operated slide-button
- Stainless steel key ring attachment

6R1-BA313 \$12.75



Smith & Wesson® Model #1850 Transport Restraints

Heavy-duty chain used to connect handcuffs and leg irons assures secure transport, while protecting both you and your prisoner. Stainless steel. 32"L. 16 oz.

6R1-RS142 \$104.99

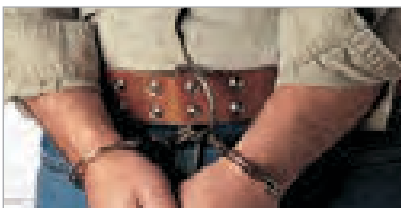

Gould & Goodrich™ Restraint Belt

Limits range of movement of prisoners' hands and arms. Heavyweight full-grain leather with heavy-duty roller buckle in back. D-ring in front attaches cuffs. Fits waists between 32"-56". Comes in Brown (cuffs not included).

6R1-RS010 \$69.49



Galls® Chain Restraint Belt

Secures a prisoner's wrists to the waist. Limits arm movements, keeping prisoner's hands always in sight. Nickel-plated chain attaches to cuffs quickly with a sturdy cuff clip. 72"L. Adjustable to any size.

6R1-RS130 \$27.69



Made with legendary ASP durability



ASP® LockWrite Pen Key

Combines two of the most frequently used police tools into a single design. The result is a pen that rivals the world's best, with a handcuff key as durable as an ASP Baton.

- Heat-treated handcuff key is constructed from 4140 steel alloy used in ASP Batons
- Polymer body made by one of the world's premiere pen manufacturers
- Long-throw pen mechanism clicks smoothly into place
- High-density ink cartridge with spare ink refill

Colors: Black/Silver, Black/Gold, Black/Black

6R1-BA315 \$27.20



Durable, Ergonomic Cuff Keys



Zak Tool® Gold Plated Pocket Style Handcuff Key

Gold finish matches with your gold-finished badge and nameplate.

- Heat-treated steel key for reliable service
- Gold-finished aluminum handle
- Double-lock pin on end
- Includes pocket clip
- 4" L

6R1-RS128 \$13.19



Galls® Pocket Handcuff Key

Easily identify your key. Lightweight. Textured aluminum handle. Steel key. Black. 4" L.

6R1-RS210 \$11.59



Galls® Carbon Fiber Pocket Clip Cuff Key

Lightweight carbon fiber body. Heat-treated steel tip. Ergonomic design. 4" L.

6R1-RS121 \$8.39



ZAK Tool® Key Corrections Chain and Belt Loop Combo

Designed with corrections officers in mind, this system allows you to carry your keys securely on your belt.

- Belt loops can be worn connected or separated to best fit the user
- Includes a dual belt loop and 24" chain

6R1-RS055 \$23.39



Galls® Cuff Key

Wide, easy-to-grip, 3/8" handle. Open center slot for key ring attachment. 3" L.

6R1-RS070 \$8.59

Zak Tool® Extended Handcuff Key

The ZAK key has a long knurled handle, so it is easy to grip.

- Steel construction
- Extended key makes it easy to use
- Double-lock pin on one end

Black. 4" L

6R1-RS310 \$10.19



Galls® Hybrid Handcuff Key

Hybrid design handcuff key. Polymer body and steel key makes it 1/3 the weight of standard rotating key. Key ring included. Black. 4" L.

6R1-RS209 \$9.19



Galls® Carbon Fiber Swivel Cuff Key

Lightweight, superstrong, swivel-style handcuff key has a carbon fiber body and a heat-treated steel tip — all in an ergonomic design. Key ring included. Black. 3 1/2" L.

6R1-RS161 \$9.69



Galls® Swivel Cuff Key with USA Flag

Swivel design with an American flag emblem. Lightweight polymer body with steel key for added strength. Key ring included. Black. 4" L.

6R1-RS235 \$10.19

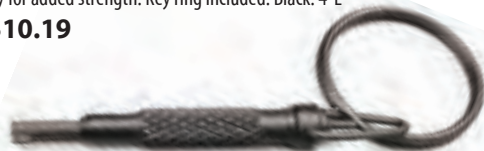

Galls® Aluminum Swivel Handcuff Key

Swivel design handcuff key. Slim, short aluminum key with textured handle makes it easy to grip and fit into any pocket. Black. 3 1/2" L.

6R1-RS208 \$11.79

Galls® Key Extender and Holder

Carry a standard key like your department regs require, but with the added length and convenience of a holder. Fits up to 2 1/4" W belts. Black. 4" L.

6R1-RS104 \$16.99



Streamlight® LED CuffMate

Stainless steel key with a 100,000-hour life LED.

- Dual LEDs for double locking and unlocking
- Includes two replaceable lithium batteries and key ring
- Momentary squeeze switch for 12+ hours
- Gives more than 1,000 ten-second bursts

Black. 3 1/4" L. Less than 4 oz

6R1-FL269 \$16.79





Trust ASP® for Reliable Self-Defense



ASP® Tactical Batons

ASP friction lock batons have superstrong aerospace alloy construction, making them sturdy and reliable.

Original Steel — Expands easily with a snap of the wrist, and then retracts to carry on your belt. Black chrome steel shaft. Black machine-foamed handle produces a firm and durable gripping surface to assure non-slip handling.

Wavemaster — Grip design provides a secure grip, even when it's wet!

Airweight — Forty-five percent lighter than the Original Steel Baton, but just as durable and dependable. Made from lightweight alloy, this baton is highly recommended for undercover or detective use. Black shaft. Black machine-foamed handle.

Electroless — Designed specifically for officers on the coast, the Electroless is rust and corrosion resistant on both the inside and outside. Steel shaft is nickel-plated and dependable in every situation.



Wavemaster Handle



Style	Shaft Color	Closed length	Expands to	Weight	Item	Price
Original	Black	6½"	16"	13.6 oz	6R1-BA113	\$99.99
Original	Black	7¾"	21"	16.5 oz	6R1-BA035	\$104.99
Original	Black	9½"	26"	20 oz	6R1-BA036	\$109.99
Wavemaster	Black	7¾"	21"	16.5 oz	6R1-BA162	\$104.99
Airweight	Black	6½"	16"	6 oz	6R1-BA115	\$99.99
Airweight	Black	7¾"	21"	8.9 oz	6R1-BA054	\$104.99
Airweight	Black	9½"	26"	10.9 oz	6R1-BA055	\$109.99
Electroless	Nickel	6½"	16"	8.5 oz	6R1-BA114	\$99.99
Electroless	Nickel	7¾"	21"	16.5 oz	6R1-BA077	\$104.99
Electroless	Nickel	9½"	26"	20 oz	6R1-BA078	\$109.99



ASP® Talon Batons

Rapidly deploy incredible strength. This revolutionary design uses two opposing discs that cam into an internal groove that is machined into each tube.

- Foamed vinyl grip and Cerakote™ (K) shaft
- Steel tubing
- Extended tip to allow the shaft to be pulled open
- Push button to close

Closed: 8 5/8" L. Open: 21" L

6R1-BA232 \$134.99

ASP® Talon Disc Loc Batons

Revolutionary design uses two opposing discs that cam into an internal groove that is machined into each tube.

- Push-button retraction
- Simple, stable and secure lockout to prevent accidental collapse
- Withstands repeated openings, closures and impact strikes
- Foamed vinyl grip
- Cerakote™ (K) finish shaft for abrasion and corrosion resistance
- Steel tubing
- Fits in standard ASP baton holder
- Matte finish for low profile

Desc.	Open	Closed	Item	Price
40 cm	15 3/4" L	6 7/8" L	6R1-BA129	\$129.99
60 cm	23 3/4" L	9 3/4" L	6R1-BA303	\$139.99

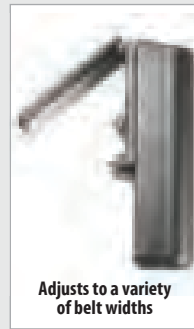

Adjusts to a variety of belt widths



Envoy 60

ASP® Envoy Rotating Baton Scabbards

A compact carrier for the ASP Talon Baton, for those who prefer a closed front case.

- Rotates to seven different positions
- Adjusts to a variety of belt widths from 1 1/4" to 2 3/4"
- Closed bottom allows the officer to retract baton while holstering
- Internal tension bar holds the baton in place

Description	Fits	Item	Price
Envoy 40	16" Batons	6R1-BA340	\$33.99
Envoy 50	21" Batons	6R1-BA282	\$38.99
Envoy 60	26" Batons	6R1-BA308	\$44.99



No Hassle Guarantee

We will repair, replace or refund an order if you are not completely satisfied with a newly purchased item. Some restrictions apply.

ASP® Breakaway Glass Endcap

Shatter glass instantly with three ceramic points.

- Standard endcap covers ceramic points
- Attaches to any ASP baton

Black. Made in the USA. 1" H x 1" W x 1 1/2" D. 3 oz

6R1-BA152 \$16.15



ASP® Leverage Grip Caps

Use with any ASP expandable baton.

- Steel construction; 360° grip

Black. 4 oz

6R1-BA096 \$13.39



ASP® Grip Endcap

Superior grip for more control over your baton.

- Steel construction; stealth-textured design
- Fits any ASP baton

Black. Made in the USA. 2" H x 1 3/4" W x 1 1/2" D. 2 oz

6R1-BA057 \$12.49



ASP® Tactical Defender

Disburse quickly and safely in a straight line at a perpetrator. Bridges the gap between your baton and a can of pepper spray. Accommodates screw-in pepper spray insert.

- Fits any ASP baton

Black. 4" L. 3 oz

6R1-BA141 \$57.99

Pepper Spray Insert **6R1-SD165 \$9.89**

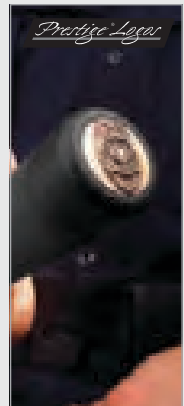
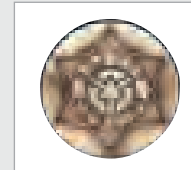
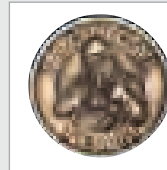
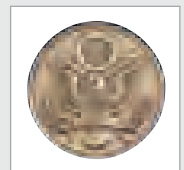
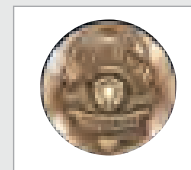
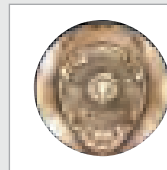
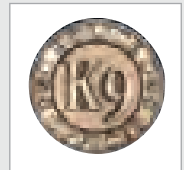
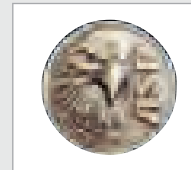
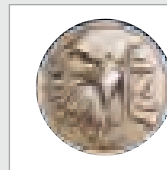

ASP® Logo Endcaps

Prestige® Logo Endcaps show attention to detail.

- Die struck
- Available logos: ASP Eagle, ASP Eagle Certified, K9^(X), Police^(X), Security, Justice, Great Seal Tactical, Sheriff^(X)

6R1-BA091 \$14.29



Visit us online for restricted item info.

Value-Packed Batons and Scabbards



Galls® Baton and Scabbard Combo by ASP®

Made by ASP exclusively for Galls, this Baton is durable, easy to handle and provides excellent retention in all conditions. Choose 21" L or 26" L to fit your needs.

Batons: 4130 Japanese Steel Alloy with Santoprene handle provides a secure grip in all weather conditions. Compatible with all ASP endcaps and accessories. Black chrome finish. Time-tested friction lock design.

Scabbards: Affordable scabbard is a low-profile, lightweight holder that will retain a retracted or expanded baton and rotate in 12 distinct positions. Top Draw. Polymer materials. Slide on belt loop, steel retention bar, belt clip and a belt lock.

Batons

Open	Closed	Item	Price
21" L	7¾" L	6R1-BA175	\$52.99
26" L	9½" L	6R1-BA192	\$64.99

Scabbards

Fits	Dimensions	Item	Price
21" L	5" L x 1¼" W x 2" D	6R1-BA176	\$26.99
26" L	6" L x 1¼" W x 2" D	6R1-BA193	\$26.99

Baton & Scabbard Combo

Desc.	Item	Price
21" L	6R1-BA184	\$77.49
26" L	6R1-BA200	\$80.19



Rubber grip for a secure hold

CASCO™

Casco™ Baton

Value-priced baton for budget-minded departments or security teams.

- Carbon steel shaft
- Friction lock design
- Wear-resistant finish
- Rubberized grip for secure hold in all environments
- Fits most 21" baton holders

Black. 21" L. 17 oz

6R1-BA067 \$73.39







Closed



A40



A50

ASP® Agent Concealable Batons

Built to the same high standards as ASP duty batons, with multiple carry options.

- 4130 steel striking surface; 7075 T6 aluminum middle shaft and handle
- Crosstec knurling for secure grip
- Removable Nexus clip allows tip-up or tip-down carry

Desc.	Open	Closed	Lock	Item	Price
A40	15¾"	7¾"	Disc Loc	6R1-BA311	\$106.25
A50	19½"	9"	Disc Loc	6R1-BA312	\$110.50



Closed





P12 P16 P21

ASP® Compact Protector Batons

The most compact series of batons on the market, the design can easily be carried in a pocket or on a belt.

- 4140 steel end shaft and tip with an aluminum midshaft and handle
- Crosstec knurling on the handle provides secure grip without the abrasion caused by traditional checkering
- Closes by striking on a hard surface
- Opens with the snap of the wrist and held securely in place by the Friction Loc®
- Adjustable clip allows you to position the baton lower in the pocket for maximum concealment or higher for easier access

Weights: **P12:** 5.4 oz. **P16:** 6.7 oz. **P21:** 7.7 oz

Desc.	Open	Closed	Item	Price
P12	11⅝"	5⅞"	6R1-BA213	\$44.69
P16	15¾"	6½"	6R1-BA214	\$50.99
P21	21"	8"	6R1-BA310	\$56.99

Adjustable clip for pocket carry



Monadnock® Classic Friction Lock

Detective® Series Batons

Have confidence, comfort and options with this Classic Friction Lock Detective® Baton. Customize with a wide variety of tips, grips and sizes to best meet your work needs. Baton has a weight-forward kinetic energy that allows baton to open faster in combat situations.

- Cold Drawn 4130 aircraft seamless alloy steel tubing with foam grip
- Opens with a flick of the wrist with Morse tapers, tight locking joints
- Power Safety Tip® option for easier closing
- Endcap uses a bore guide over the end shaft and retention spring, reducing breakage
- Lifetime repair or replacement
- Black chrome finish

Made in the USA

Length	Tip	Closed	Wt (oz)	Item	Price
16"	Safety Tip™	6½"L	15	6R1-BA185	\$79.99
21"	Safety Tip™	8"L	17	6R1-BA186	\$87.39
26"	Safety Tip™	9¾"L	23	6R1-BA188	\$93.99



Monadnock® AutoLock Standard Expandable Batons

No more having to strike hard surfaces to close your baton! AutoLok batons close by pushing a button in the endcap and sliding the shaft back into the handle with the palm of your hand.

- 4130 seamless aircraft alloy steel
- Control suspects more safely with **Safety Tip®** made of hard rubber, or **Power Safety Tip®** made of urethane, which reduces blunt trauma
- Opens with a flick of the wrist, or by pulling the shaft out by the reinforced rubber tips
- Foam handle for secure grip

Black. Made in USA

Length	Tip	Closed	Wt (oz)	Item	Price
18"	Power Safety®	9"L	19	6R1-BA028	\$154.99
21"	Safety Tip®	8¾"L	19	6R1-BA056	\$139.09
22"	Power Safety®	10"L	22	6R1-BA084	\$144.69
26"	Power Safety®	11½"L	22	6R1-BA089	\$146.99



Patented Push-Button Closure

Baton Holders

For 21"	6R1-BA072	\$28.99
For 22"-26"	6R1-BA086	\$29.99

Price Match Guarantee

We will match the price of an item found on the Internet for a lesser price and currently for sale by Galls. Some restrictions apply.



ASP® Sidebreak Rotating, Paddle and Clip-On Scabbards

Choose rotating or paddle and plate slide-on or clip-on. Adjusts for any five positions. Will not impede or cause discomfort because it moves where you need it to. Fits three different length batons.

- Polymer construction with an adjustable clip for attachment to virtually any belt width
- Accommodates a closed or fully extended baton
- Bottom of scabbard is partially closed to prevent collapsed baton from shaking open

Fits	Item	Price
16"	6R1-BA112	\$31.79
21"	6R1-BA004	\$36.69
26"	6R1-BA009	\$40.99

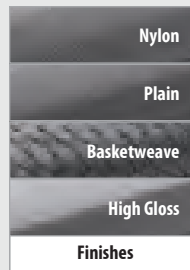

Finishes



Scabbard rotates for comfort when sitting or bending



Remove spacer to fit ALICE belt

Easy On/Off Attachment

Self-Defense Sprays



DEFENSE TECHNOLOGY

Compare Spray Methods

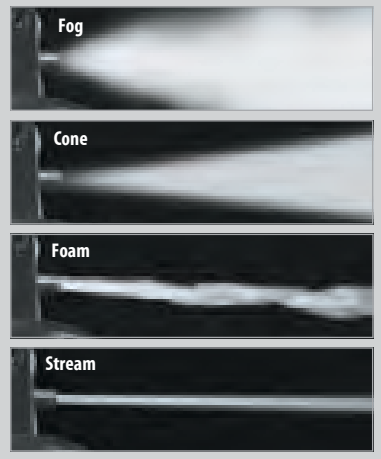

Defense Technology® Personal and Police Size Stream Sprays

First Defense Spray uses a .2% Major Capsaicinoid level pepper formula that irritates nerve endings near the skin's surface for a burning sensation on contact. Use the classic (SD085, SD086, and SD089) First Defense formula with a .2% Major Capsaicinoid level for general use. MK-3 and MK-4 (SD158 & SD159; see below) have the additional capability to be used at any angle.

- Nonvaporizing so user is not affected during transport of the person sprayed
- Electronic Discharge Weapon (EDW) safe
- Five-year warranty from date of manufacture

Description	Dimensions	Volume	Item	Price
MK-3	4¼"H x 1½"W	1.5 oz	6R1-SD158	\$11.79
MK-4	6¼"H x 1½"W	3 oz	6R1-SD159	\$14.09
Police MK-3	4¼"H x 1½"W	1.5 oz	6R1-SD085	\$11.79
Police MK-4	6¼"H x 1½"W	3 oz	6R1-SD086	\$12.79
Police MK-9 Stream	9"H x 3½"W	12 oz	6R1-SD089	\$41.39
MK-3 Inert Training Unit	4¼"H x 1¼"W	1.5 oz	6R1-SD033	\$10.69
MK-4 Inert Training Unit	6¼"H x 1¼"W	3 oz	6R1-SD034	\$11.59



Defense Technology® X2 .4% Stream Sprays

Two times the Capsaicinoids for a stronger effect. X2™ is made from the same ingredients; only the proportions differ.

- Nonflammable
- Water based
- Electronic Discharge Weapon (EDW) safe
- Five-year warranty from date of manufacture



Desc.	Dimensions	Item	Price
MK-3	4¼"H x 1¼"W	6R1-SD131	\$13.09
MK-4	7"H x 1¼"W	6R1-SD132	\$14.09



DEFENSE TECHNOLOGY

Defense Technology® Fast-Acting .4% Foam

Sprayed foam sticks to the object and then melts, covering the entire area.

- Eyeglasses offer no resistance
- Same formula as 10% Pepper Spray
- Electronic Discharge Weapon (EDW) safe
- Five-year warranty from date of manufacture



Desc.	Dimensions	Item	Price
MK-3	4¼"H x 1½"W	6R1-SD090	\$12.19
MK-4	6¼"H x 1½"W	6R1-SD091	\$14.09

Defense Technology® Deftech 1.3% OC Foam

Deftech MK3 and MK4 1.3% OC Foam is an intense OC formula with the advantages of foam.

- 1.3% formula is the most intense formula on the market today
- Offers extreme intensity without complicating the decontamination process or liability issues
- Nonflammable and Electronic Discharge Weapon (EDW) safe



Desc.	Dimensions	Item	Price
MK-3	4¾"H x 1½"W	6R1-SD197	\$12.19
MK-4	6¼"H x 1½"W	6R1-SD198	\$14.09

in a Variety of Delivery Systems

Galls Pepper Sprays
Starting at

\$13⁸⁹



Galls® 10% Oleoresin Capsicum with 1.33% Major Capsaicinoids

Pepper spray irritates nerve endings near the skin's surface, causing a burning pain upon contact when released in the direction of a perpetrator. The formula is nonvaporizing so it won't affect officers transporting sprayed suspects. Five-year shelf life warranty.

Pepper Sprays

Description	Spray	Dimensions	Volume	Item	Price
MK-3	Stream	4 3/8"H x 1 1/2"D	1.5 oz	6R1-SD139	\$13.89
MK-6 Personal	Stream	4 3/8"H x 1 1/4"D	.6 oz	6R1-SD141	\$15.99
MK-4	Stream	6 1/4"H x 1 1/2"D	3.1 oz	6R1-SD140	\$16.99
MK-9	Stream	9 1/2"H x 2 3/8"D	13 oz	6R1-SD142	\$60.79

Training Units

MK-3	Stream	4 3/8"H x 1 1/2"D	1.5 oz	6R1-SD143	\$12.79
MK-4	Stream	6 1/4"H x 1 1/2"D	3 oz	6R1-SD144	\$15.99
MK-9	Stream	9 1/2"H x 2 3/8"D	13 oz	6R1-SD146	\$49.99



MK6
Personal
Size

Police Sizes



MK-3

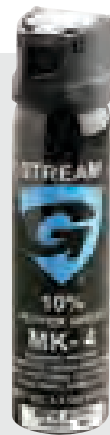

MK-4



MK-9



Most sizes available in inert training versions

Fox Labs® Defense Sprays

Choose stream or cone delivery system, flip-top or pistol-grip dispenser.

- Spring-loaded protective cap prevents accidental discharges
- FOX 5.3 is a 2% Oleoresin Capsicum (OC) formula, rated at a true 5.3 million Scoville Heat Unit (SHU)
- Non-lethal, non-flammable, aerosol defense spray affords all the stopping power of high percentage formulas while reducing recovery time and liability concerns
- Lower percentages of OC decrease liability risks
- Five-year shelf life warranty

Description	Volume	Item	Price
OC Heavy Stream MK-3	2 oz	6R1-SD112	\$15.59
Cone Fog Spray MK-3	2 oz	6R1-SD115	\$14.99
OC Heavy Stream MK-4	3 oz	6R1-SD113	\$18.89
Cone Fog Spray MK-4	3 oz	6R1-SD116	\$18.39
OC Heavy Stream MK-5	4 oz	6R1-SD114	\$21.49
Cone Fog Spray MK-5	4 oz	6R1-SD117	\$21.19
Crowd Control Fogger MK-9	16 oz	6R1-SD215	\$47.89



MK-3



MK-4



MK-5



MK-9



Vexor Flip Top Micro Spin Stream

Zarc's patented MicroSpin pattern with traditional flip-top actuator.

- 1.45% Major Capsaicinoids
- MicroStream technology
- Approximately 9 bursts per unit
- Shoots a riffling stream

Description	Volume	Item	Price
MK-3	1.8 oz	6R1-SD294	\$16.69
MK-4	3.5 oz	6R1-SD297	\$17.79



Mace® Takedown Pepper Gel

Revolutionary gel formula sticks like glue! Shut down attackers and reduce cross-contamination.

- Suspended in gel instead of a liquid stream
- 1.4% Capsaicinoid concentration produces 2 million SHU's of burning, irritating heat
- Spray distance up to 25 feet
- Flip-top safety cap prevents accidental spraying

Description	Volume	Item	Price
MK-3	1.59 oz	6R1-SD163	\$19.19
MK-4	2.79 oz	6R1-SD161	\$22.39



Self-Defense Sprays and Accessories



SABRE

SABRE® Red Crossfire Sprays

Deploys OC spray from any angle, increasing your ability to hit the suspect.

- Uses time-tested SABRE Red formula: 10% OC, 1.33% Capsaicinoid content
- EDW safe, electronic immobilization device compatible EDW safe
- MK-3 fires 10 one-sec bursts
- MK-4 fires 16 one-sec bursts
- Five-year shelf life warranty

Description	Dimension	Volume	Item	Price
MK-3	½"H x 1½"D	1.4 oz	6R1-SD147	\$14.59
MK-4	6¼"H x 1½"D	3 oz	6R1-SD148	\$16.99



SABRE

SABRE® Defense Sprays

SABRE guarantees a Heat Level I (quick decontamination) and Level III (maximum restraining power) defensive sprays.

- In-house High Pressure Liquid Chromatography Laboratory (HPLC) tests assure that each formula produced meets the standards for its heat level, assuring the same results every time
- SABRE Dual Propellant Sprays (DPS) fire four times longer than other sprays
- Level I: 10% OC, 0.33% Capsaicinoid content
- Red Level III: 10% OC, 1.33% Capsaicinoid content
- Five-year shelf life warranty

Level I

Description	Spray	Dimension	Volume	Item	Price
Water Based MK-3	Stream	5"H x 1½"D	1.8 oz	6R1-SD224	\$13.19
Water Based MK-4	Stream	6"H x 1½" D	4.4 oz	6R1-SD225	\$15.29
(DPS) MK-9	Heavy Fog	10"H x 2½"D	11 oz	6R1-SD218	\$53.29

Red Level III

Description	Spray	Dimension	Volume	Item	Price
(DPS) MK-3	Cone	4"H x 1½"D	2 oz	6R1-SD121	\$14.19
(DPS) MK-4	Cone	6"H x 1½"D	4.4 oz	6R1-SD120	\$18.69
(DPS) MK-9	Heavy Fog	10"H x 2½"D	18.5 oz	6R1-SD221	\$65.29
Water Based MK-3	Stream	5"H x 1½"D	1.8 oz	6R1-SD226	\$13.19
Water Based MK-4	Stream	6"H x 1½"D	4.4 oz	6R1-SD227	\$15.29
Water Based MK-6	Stream	4"H x 1½"D	0.7 oz	6R1-SD124	\$13.19



SABRE

SABRE® Crossfire Pepper Gel

OC technology increases target acquisition when controlling dynamic subjects.

- Gel breaks down into a liquid faster than a foam spray
- Canisters deploy continuously from any position
- Reduced cross-contamination and increased range
- Range: 12-15 ft
- MK-3 fires 10 one-sec bursts
- MK-4 fires 16 one-sec bursts

Description	Dimension	Volume	Item	Price
MK-3	4¾"H x 1½"D	1.8 oz	6R1-SD199	\$14.59
MK-4	6¼"H x 1½"D	3 oz	6R1-SD250	\$16.69

SABRE

SABRE® DECON Cleanse and Soothe Kit

Kit contents do not drive chemical agents into skin.

- Step 1 uses Cleanse to remove chemical agent from surface of skin
- Step 2 uses Soothe to moisten skin for more rapid recovery
- Eliminates chemical agent reactivation
- Two-year shelf life
- Includes two 4 oz bottles

6R1-SD167 \$20.29



Smith & Wesson

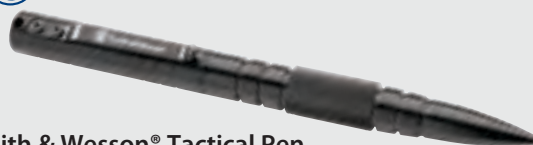

Smith & Wesson® Tactical Pen

Aluminum pen works both as a writing tool and defense weapon. Uses Parker, Hauser or Forey .7mm refills. Includes black ink cartridge and pocket clip. Black. 1.9 oz

6R1-BA173 \$32.59



Street

Key

Palm



ASP® Defender

Comes in three styles. Anodized aluminum cylinder with replaceable aerosol HEAT® insert dispenses a burst of one of the hottest formulas of OC spray!

- Fits conveniently in hand, in pocket or on key ring
- O-ring sealed tip
- Safety switch and cone-shaped spray

Colors: Palm and Key available in all colors. Street available in Black

Desc.	Dimension	Volume	Item	Price
Palm	4½" L	2 oz	6R1-SD212	\$28.69+
Key	5¾" L	2 oz	6R1-SD082	\$30.39+
Street	6½" L	5 oz	6R1-SD169	\$40.19
Palm Refill	6R1-SD213	\$7.19		
Key Refill	6R1-SD083	\$7.99		
Street Refill	6R1-SD211	\$8.89		



Quick-Release Safety Switch

Check descriptions for availability



Visit us online for pricing on additional options.

MONADNOCK®



Monadnock® Persuader

Strong, durable polycarbonate. Includes one O-ring. Black. 5½" L.

6R1-BA039 \$8.69



SABRE

SABRE® Spitfire Pepper Spray

Small size makes it easy to conceal, and internal safety prevents accidental spraying.

- Police strength measures 2,000,000 on Scoville heat unit scale
- Patented dispenser for speed and accuracy point and shoot
- Environmentally safe and nonflammable; ozone friendly
- Refill (SD129): Can be flat tested to determine if refill is necessary

6R1-SD126 \$14.59

Refill **6R1-SD129 \$9.99**

Need Your Products Fast?

We carry a large assortment of products in-stock and ready to ship today!

Black

Pink

Black/Translucent

Pink/Translucent

SABRE

SABRE® Red Civilian Defense Key Chains

Hard case comes with detachable key chain and SABRE Red Defense Spray.

- 0.5 oz canister delivers a stream and reduces wind blow-back about 8-10'
- Compact canister contains approximately 25 shots
- For each Pink canister purchased, SABRE will make a donation to the National Breast Cancer Foundation
- Two-year warranty and four-year shelf life

Pink and Black: 4" H x 1" D. Pink and Black with translucent case: 3½" H x 1" D

Description	Item	Price
Pink	6R1-SD175	\$11.79
Black	6R1-SD232	\$11.69
Pink/Translucent	6R1-SD182	\$9.69
Black/Translucent	6R1-SD183	\$9.69

Essential Equipment for Self Defense Training



RedMan
Training Gear

RedMan® XP Suit

This 13-piece suit features plastic trauma plates that are doubled in thickness and molded into a wave to disperse more shock. For training use only – not for ballistic use.

- Reduced foam thickness yet maintains superior protection
- Repairs are easily done without having to return the product to the factory

Includes carrying bag. *Suit shipped via ground only*

6R1-TN118 \$1,620.69

RedMan® 4x4 Package

Allows for more realistic multi-suspect training.

- XP suit
- 4 student suits
- Special Configurations Pak: 1 Enhanced Head Assembly (Enhanced Head, Throat and Collar), 1 pair Inner Forearm Guards, 1 Enhanced Lower Abdominal Pad and "No Foul" Groin Guard, 1 pair Foot Guards, 1 Attachable Face Shield, 1 pair Elbow/Forearm Guards, 1 pair Self-Defense Punch, Body Guard Protector, 4 inert OC sprays
- Accessory Pak includes: 4 Training Batons, 2 Striking Shields, 3 Equipment Bags, 2 Disinfectant Cleaners, 1 Repair Kit

6R1-TN046 \$4,663.99

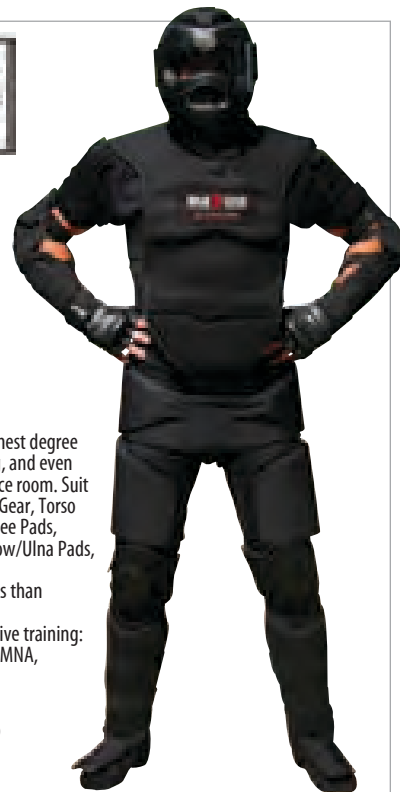

High Gear Complete Training Suit

Impact-reducing suit provides highest degree of flexibility for striking or fighting, and even be flex-cuffed in the field or practice room. Suit contains eight components: Head Gear, Torso Protector, Combat Shorts, Shin/Knee Pads, Throat Guard, Combat Gloves, Elbow/Ulna Pads, and Peroneal Pads.

- Dress and begin training in less than three minutes
- Ideal for any aspect of combative training: detainee handling drills, CQB, MNA, grappling and striking arts

Weights 9-11 lbs

6R1-TN322 \$2262.69

VISIT US ONLINE



Find more training equipment online at:
galls.com/training

Shop for training handcuffs on p. 322

RedMan
Training Gear

RedMan® Training Bag

This training bag protects you during baton training.

- Supported three-handle back
- Tough enough to use with a duty baton
- Closed cell, high-density, protective foam

Black and Red. Made in USA.
30"H x 19½"W x 5½"D.

Shipped via ground only

6R1-TN345 \$169.99



Baton Training Center

ASP® Baton Training Bag

For training with expandable, side handle or straight batons

- Durable and reinforced vinyl
- Foam insert

Black. 29"H x 21"W x 4½"D.
5½ lbs. *Shipped via ground only*

6R1-TN049 \$187.49



ASP® Training Batons

- Reduces injury potential
- Allows dynamic, high-level simulations

21" **6R1-TN044 \$59.79**
26" **6R1-TN045 \$61.69**



Train Safely with Inert Weapons



S&W M&P 9mm/.40



M4 Carbine Extended Stock



Knife



M4 Carbine with Sliding Stock



Actual weight training weapons available



Remington 870



Sig 229 DAK 9mm/.40

ASP® Red Guns Training Weapons

We know you'll appreciate our selection of training aids because simulation training is the next best thing to experience when defending yourself.

- Made of rust-proof molded urethane
- Shaped, sized and detailed to duplicate live weapons

Description	Item	Price
Knife	6R1-TN011	\$20.00
S&W M&P 9mm/.40	6R1-TN123	\$49.19
Sig 229 DAK 9mm/.40	6R1-TN121	\$49.19
Beretta 9mm/.40 Compact	6R1-TN014	\$49.19
Remington 870	6R1-TN043	\$200.89
Government M16	6R1-TN026	\$200.89
M4 Carbine Extended Stock	6R1-TN054	\$200.89
M4 Carbine Collapsed Stock	6R1-TN185	\$200.89
M4 Carbine Sliding Stock	6R1-TN186	\$236.49

Description	Item	Price
Beretta 9mm/.40	6R1-TN039	\$49.19
Sig 228/229	6R1-TN020	\$49.19
Sig 220/226, 9mm/.45	6R1-TN041	\$49.19
S&W J Frame	6R1-TN025	\$49.19
S&W K Frame	6R1-TN042	\$49.19
H&K USP 9mm/.40	6R1-TN019	\$49.19
Flashlight	6R1-TN010	\$49.19
Actual Weight Beretta 9 mm	6R1-TN048	\$66.99
Actual Weight Sig 228/229	6R1-TN051	\$66.99



Colt 1911



M4 Open Stock



Glock 17/22/31



Glock 42



Ruger LCP

BLUEGUNS

BlueGuns® Training Weapons

The most realistic alternative to live firearm exercises. Exact casting of actual weapon helps law enforcement develop a real feel for rough and tumble scenarios.

- Polyurethane impact-resistant with steel reinforcing to prevent bending or flexing
- Rail guns accept mounted accessories
- Handguns fit in high-security duty holsters, engaging safety devices
- Law Enforcement Blue, recognized safety color

Description	Item	Price
Glock 17 Gen 4	6R1-TN154	\$51.29
Glock 17 with TLR1 Tactical Light	6R1-TN145	\$50.79
Glock 17 with M3 Tactical Light	6R1-TN140	\$50.79
Glock 17/22/31	6R1-TN061	\$50.79
Glock 17/22/31 with M5 Tactical Light	6R1-TN232	\$51.29
Glock 19/23/32	6R1-TN062	\$51.29
Glock 21	6R1-TN234	\$50.79
Glock 42	6R1-TN194	\$50.79
S&W M&P 9/40	6R1-TN330	\$51.29
Sig P226	6R1-TN075	\$50.79
Sig P229	6R1-TN326	\$51.29
Sig P229 DAK with Rails	6R1-TN327	\$51.29
Colt 1911	6R1-TN060	\$50.79
Ruger LCP	6R1-TN155	\$50.79

Glock 17 with M3 Tactical Light



Glock 17 Gen 4

Taser® X2



Glock 17 with TLR1 Tactical Light

Taser® X2	6R1-TN376	\$51.29
Taser® X26P	6R1-TN156	\$51.29
Remington 870	6R1-TN103	\$179.69
Remington 870 with 14" Barrel	6R1-TN104	\$179.69
H&K MP5A2	6R1-TN098	\$179.69
M4 Open Stock	6R1-TN096	\$179.69



Radians® Transverse Electronic Earmuff

Amplifies low level sounds but compresses noises that exceed safe levels.

- NRR 20 dB
- Dual microphones with independent volume controls
- Uses 4 AAA batteries (sold separately)

6R1-HP025 \$54.99

AAA Batteries **6R1-FH206 \$4.99/2pk**



Howard Leight Electronic Muff

- Blocks harmful noise above 82db
- Folds for easy storage
- Uses 2 AAA batteries (included)

6R1-HP051 \$60.89

AAA Batteries **6R1-FH206 \$4.99/2pk**



Sharp Edge
Smoke

Blade Runner
Smoke

Edge Eyewear™

Sharp edge lenses shape sweeps back to provide good peripheral vision.

- Meets ANSI Z87.1 and Military MCEPS GL-PD 10-12 ratings
- Blocks 99.9% of UVA, UVB and UVC rays
- Tinted lenses block the brightest sun rays without producing any color distortion
- Soft TRP temple tips increase "GRIP"
- Fog resistance improves visibility
- Triple dipped anti-scratch coating
- Includes storage/cleaning bag

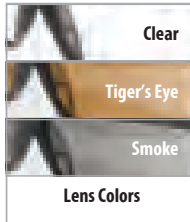

Sharp Edge: Combines ANSI and Military MCEPS protection in one stylish pair of sunglasses. Black frame.

6R1-EW543 \$29.99

Blade Runner: Half-frame design gives excellent vision with wrap-around side protection

Lenses	Item	Price
Clear, Tiger's Eye, Smoke	6R1-EW535	\$39.99
Smoke Polarized	6R1-EW534	\$69.99



Includes interchangeable Smoke Gray, Clear and HC Red lenses



Tifosi® Tactical Safety Interchangeable Sunglasses

Lightweight glasses provide high velocity impact protection and includes multiple lenses for different light situations.

- Meets ANSI Z87.1 impact standards
- Grilamid TR 90 NZZ frames, polycarbonate lenses
- 100% UVA, UVB and UV 400 rays

Black frame

\$68.99

Veloce Half-Frame with Interchangeable Lens	6R1-EW814
Dolomite 2.0 Full-Frame with Interchangeable Lens	6R1-EW816
Veloce with Smoke Gray Lens	6R1-EW815 \$48.99
Dolomite 2.0 with Smoke Gray Lens	6R1-EW817 \$48.99



Gold Frame
Brown Lens



CrossFire Core Eyewear

Ultra-light frame design provides memory flex comfort and added durability.

- Meets and exceeds ANSI Z87.1 impact Standards
- Resists penetration from high speed objects
- 100% optically correct polycarbonate lenses
- Comfort fit TPR nosepieces
- Brow contact relief guard
- Blocks 99.9% of harmful UVA and UVB rays

6R1-EW181
Polarized **\$42.69**
Standard **\$17.69**



Oakley® SI Fives Squared Sunglasses

If ordinary sunglasses just don't fit, Fives Squared is the answer. Unlike conventional sunglasses that stick out at the sides, this frame uses Condensed Cranial Geometry for a tapered architecture that feels as good as it looks. It's a look that soaks sophistication in adrenalin.

- Meets ANSI Z87.1 standards for optical performance and impact protection
- Three-Point Fit™ maximizes comfort while holding the lenses in precise optical alignment
- Innovative HIGH DEFINITION OPTICS® provide extended peripheral vision and optimized side protection

Matte Black frame with gray lenses

6R1-EW209 \$110.00



Aimpoint

Aimpoint® Patrol Rifle Optic

Incorporates many never before seen features to maximize this sight's performance within the challenging conditions faced by modern law enforcement.

- 2 minute of angle red dot for accurate target engagement at all distances
- Compatible with all generations of night vision devices and may be used with Aimpoint 3X Magnifier and Concealed Engagement unit
- Hard anodized aluminum alloy housing
- Transparent rear flip cover allows use of the sight even with both covers closed in an emergency
- Modular mount set-up for use on flat-top AR15, M4 Carbine and M16 rifle
- QRP2 rail grabber mount

5" x 2 1/4" x 2 1/4". 11.6 oz

6R1-SA405 \$424.00

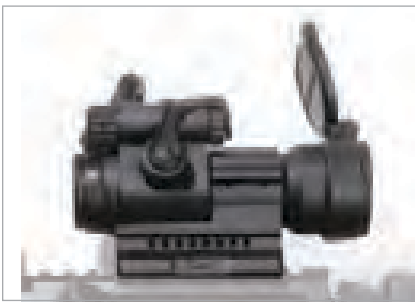

Aimpoint

Aimpoint Red Dot Sights

Full-sized performance in a lightweight, reduced-sized package.

- Aluminum body
- Waterproof
- ACET technology allows 50,000 hours of operation on one battery
- No laser emission that could be damaging to the eye
- Patent pending mount is keyed to the sight body to absorb recoil
- Precision adjustment for windage and elevation, no other tools required

2 1/2" x 1 1/2" x 1 1/2". 3.7 oz



NEW

H-1: Unlimited field of view, unaffected by severe surroundings and harsh weather. Delivers impressive run time and red dot performance. 12 settings for daylight and dusk. Available in 2 MOA or 4 MOA (minutes of angle).

6R1-SA569 \$629.99

T-2: The night-vision compatible T-1 works perfectly as a stand-alone or attached on larger scopes or optics. Four night vision compatible settings and eight daylight settings; one extra-bright for use with laser protection glasses or in bright desert sunlight. 2 MOA dot.

6R1-SA568 \$705.00



Steiner® Micro Reflex Sight (MRS)

Achieve fast target acquisition with the Steiner® MRS (Micro Reflex Sight). Perfect for patrol rifles, this compact sight provides an instant aiming point in all light conditions.

- 1X magnification
- 21x15 mm lens
- Mount compatibility: MIL-STD 1913 Picatinny rail
- Hard broadband AR coating
- Automatic brightness control, and 3 steps manual adjustment
- Water submersion: 10 meters, 10 min
- Operating temperature: - 25 to + 55 °C
- Storage temperature: - 40 to + 70 °C
- CR 1632 battery
- 550 hours battery life

Measures 1 3/4" L x 1 3/4" W x 1 1/2" H, including mount. Weight 2.5 oz including mount

6R1-BN146 \$459.99



EOTech® HOLOGraphic Weapon Sight

Engage with both eyes open when faced with multiple threats in tactical situations.

- Wide field of view
- 1X optic, no magnification
- 20 reticle brightness settings for use in any lighting conditions
- Fog, shock and waterproof (submersible to 10 ft)
- Withstands extreme temperature variations
- Mounts to any Mil Std. 1913 Picatinny or 1" Weaver rail

552: Compatible with Gen I-IV Night Vision Systems. Tandem Operations. Includes AA batteries. 5 1/2" x 2" x 2 1/2". 11.1 oz.

6R1-SA078 \$529.00

XPS2: Shortened base only requires at most a 2 3/4" of rail space. Single CR123 battery (included) reduces sight length. 3 3/4" x 2" x 2 1/2". 9 oz.

6R1-SA262 \$499.00

CR123 Batteries **6R1-FH211 \$19.99/6 pk**



AmeriGlo Tritium Night Sights

AmeriGlo sights are used across the globe by law enforcement, military and shooting enthusiasts. Engineered from American-made bar stock steels and assembled with Swiss-made, photo luminescent tritium light sources.

\$99.00

Classic Three Dot Tritium Sight: Easy-to-see white-outlined green tritium vials in the front and rear.

6R1-SA573

Pro I-Dot Tritium Sight: Photo luminescent front-sight outlines. Glock® set features a green rear dot and a green front sight with a high-visibility orange outline.

6R1-SA576



NEW



Front and Rear Green Tritium Insets



Hi-Vis Orange Tritium Front

Shop our selection of weapon lights on p. 200

Keep Your Weapons and Accessories



Plano® Ammo Field Box

Features a water-resistant O-ring seal to keep your ammo dry and protected. The lid is firmly secured with a brass latch and the heavy-duty handle allows for easy carry. These stackable ammo cans are constructed with durable high quality plastic to last many years.

- Holds 6-8 boxes of ammunition
- Polymer construction
- Water-resistant O-Ring seal

OD Green. 7 $\frac{1}{8}$ "H x 11 $\frac{1}{8}$ "W x 5 $\frac{1}{8}$ "D. 424 cu in

6R1-SA010 \$10.19



Stack-On® Gear Box

Keep your handguns and gear secured with the Stack-On Gear Box. It can be used as a single unit or connected for multiple-unit applications and can be configured to open in any direction.

- Steel, welded box construction for greater strength and durability
- Locking mechanism with key-coded lock passes through steel door and is secured behind the steel door frame
- Full-length, piano type hinge allows the door to open 180° for greater access
- Includes foam padded bottom and pre-drilled holes for mounting to a shelf (includes fastening hardware)
- Can be positioned to open in any direction

Black. 7 $\frac{1}{4}$ "H x 6 $\frac{1}{2}$ "W x 11"D. 518 cu in. Includes 2 keys

6R1-SF010 \$40.59



Converts from shoulder strap to backpack

5.11

5.11 Tactical® Shock Rifle Cases

Durable, versatile, cost-effective protection for your rifle or carbine. Built with a 600 denier polyester outer shell, featuring a padded interior with internal retention straps and locking main compartment zippers. Quickly converts from shoulder strap carry into a simple backpack.

- Padded interior lined with 300D polyester
- Internal rifle retention straps
- Locking main compartment zippers
- ID window and WriteBar™ for easy identification

6R1-BG460
36" **\$79.99**
42" **\$84.99**

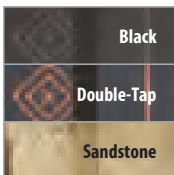

Handgun Clearing System



Concept Development Corp. Weapons Containment Systems

Systems aim weapons in a safe direction during unloading, preventing ricochet in the event of a misfire. Both systems are built to withstand multiple hits. Choose one system for Handgun Clearing and the other for Armor Piercing weapons.

- Approved for Federal Law Enforcement Use
- Handgun system features a steel and rubber construction that stops all handgun ammunition
- Armor piercing system features a steel and ceramic construction that stops rounds up to (but not including) .50-caliber BMG
- Both systems can be portable for use in trunk of squad car, desktop, or other surfaces without permanent mounting
- For permanent mounting, handgun system can be bolted to a wall or other surface, while the armor piercing system can be bolted to either a stationary or portable tripod base

Description	Item	Price
Handgun Clearing System	6R1-SA169	\$415.69
Armor Piercing System Only	6R1-SA246	\$719.59
Armor Piercing System with Permanent Base	6R1-SA244	\$944.89
Armor Piercing System with Portable Base	6R1-SA245	\$927.19



B-21 Police Silhouette

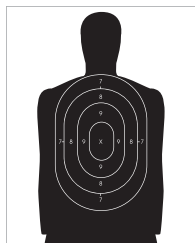

B-27 Police Target



Blue Transitional

Target Silhouettes

All include 100 targets per box. Ships via ground service only.

B-21 Police Silhouette – printed in black on heavy-duty white paper. 45"H x 35"W.

6R1-SA072 \$75.59/box

B-27 Police Target – printed in black on heavy-duty white paper. 45"H x 35"W.

6R1-SA073 \$75.59/box

Blue Transitional Target – printed on buff paper in color. 35"H x 22 $\frac{1}{2}$ "W.

6R1-SA064 \$80.89/box

VISIT US ONLINE



Find more shooting accessories online at:
galls.com/shooting-range-gear

Secure and Protected

STACK-ON!

Stack-On® Digital Security Safe

An affordable keyed, heavy-duty steel security safe to guard your valuables.

- Solid steel pry-resistant door is 6 mm thick
- 2 live action locking bolts and concealed hinges for greater security
- Programmable electronic lock
- Time-out period with three incorrect combination attempts
- Safety key override
- Removable shelf for added storage
- Foam padded bottom
- Large strong box safe with electronic lock (AA batteries included)
- Pre-drilled holes for floor or shelf mounting (hardware included)

11 $\frac{1}{2}$ "H x 15"W x 11 $\frac{1}{8}$ "D. 2,115 cu in

6R1-SF050 \$111.69



STACK-ON!

Stack-On® Personal Safe with Biometric Fingerprint Lock

The Stack On Quick Access Safe with the convenience of Biometric lock is designed for the quickest access possible.

- Simply put your finger on the pad to open your safe
- State of the art biometric lock can accept 32 different finger prints
- Standard electronic keypad backs up the biometric keypad
- Low battery warning light
- Automatically goes to a time-out period with three incorrect keypad entries
- Combination is easy to change
- Solid steel pry-resistant plate steel doors
- Foam padded bottom shelf
- Removable steel shelf
- Tested and listed as a California DOJ firearms safety device

13 $\frac{1}{8}$ "W x 9 $\frac{1}{8}$ "D x 9 $\frac{1}{8}$ "H. 1,353 cu in

6R1-SF076 \$141.99



STACK-ON!

Stack-On® Security Cabinets

Security cabinets are manufactured with welded steel for additional security and durability.

- Three-point locking system for greater security
- Drill-resistant, key-coded, tubular-key lock
- Foam-padded bottom and barrel rests reduce scratches
- Full-length welded and staked steel piano hinge
- Flush-mount bottom for easier fastening to the floor
- Steel pegboard on inside for hanging storage
- Pre-drilled mounting holes allow for easy attachment
- Fastening hardware included
- Durable baked epoxy finish

Additional freight charges may apply.

Pistol Ammo: Perfect for holding pistols, ammo and other supplies. Two removable shelves.

18"H x 21"W x 10"D. 3,780 cu in

6R1-SF040 \$107.99

8 Gun: Holds up to eight 54" tall rifles and features barrel rests and standoffs for scoped guns.

55"H x 21"W x 10"D. 11,550 cu in

6R1-SF068 \$202.99

Vertical Double Door: Stores eight rifles or shotguns up to 54" tall. Barrel standoff for scope guns. Two bins can be hung on pegboard door. Cabinet at bottom can be accessed without opening gun cabinet.

64 $\frac{1}{2}$ "H x 21"W x 10"D. 13,545 cu in

6R1-SF046 \$283.19

Convertible Double Door: Keep ammo, firearms, valuables or evidence in one handy location under lock and key. Gun cabinet holds 16 long guns up to 54" tall. Convertible cabinet has four removable foam padded steel shelves and reinforced door. Non-marring, foam-padded barrel rests and bottom.

55"H x 38"W x 18"D. 37,620 cu in

6R1-SF054 \$567.99



Pistol Ammo

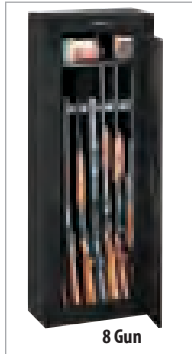

8 Gun



Vertical Double Door

Shop our selection of range-ready gear bags on p. 224



Convertible Double Door



Level II



Level III



BLACKHAWK!® SERPA™ Tactical Holsters

Active retention system automatically locks the weapon as you holster it.

- Made from a blend of carbon fiber and impact-modified nylon
- Press SERPA™ lock device on outside of holster with trigger finger to release
- Forces you to auto-index trigger finger in safe position when you draw
- When weapon is seated back in holster, it automatically locks in place
- Fully covered trigger guards for added security
- Unique clip-detachable Y-harness moves with you and doesn't bind like single strap drop-leg holsters

Weapon Fits: Glock 17, Beretta 92F

Description	Item	Price
Level II	6R1-TE324	\$136.99
Level III Hood on Holster	6R1-LP622	\$159.99



6004 SLS

SAFARILAND

6004 SLS with light option

Safariland™ 6004 SLS Tactical Leg Holsters

Access your weapon in a single-motion draw, then securely holster with a Self-Locking System.

- Safarilaminat™ construction
- Unique rotating hood can only be released by simultaneously pushing hood down and rotating it forward
- Top draw, straight drop cant and no snap for a smoother single-motion draw
- Adjustable tensioning device

6004 SLS: Suede-lined Thermal-molded Safarilaminat™ construction

6R1-LP278 \$139.99

6004 SLS with Light Option: Sizes: Size 1 (fits 92F with SureFire 3V) or Size 2 (fits Glock 17 and 23 with M3). Specify gun make and model, right or left hand

6R1-LP376 starting at \$161.79+

Optional Sentry Safety Switch. Specify right or left hand 6R1-LP277 \$7.69
Double Mag Pouch. Specify gun make and model 6R1-LP281 \$33.79



Visit us online for pricing on additional options.

Find more holsters, belts and duty gear starting on p. 282



Black

Coyote Brown

MultiCam®

Olive Drab

Wolf Gray

High Speed Gear™ Cobra Belt with Integrated D-Ring

Attach all of your High Speed Gear Taco pouches to the tactical belt. It features an integrated D-ring for quick release and ballistic nylon construction for durability.

- 2 layers of 1¾" W ballistic nylon webbing
- Quick-release, stainless steel, D-ring Cobra buckle
- Sewn together with 5 rows of bonded 138 nylon thread
- Loop VELCRO® brand lining for belt stability with mounted holsters and pouches

Made in the USA. Sizes: S (28-30), M (32-34), L (36-38), XL (40-42), 2X (44-46).

3X (48-50). Colors: Black, Coyote Brown, MultiCam®, Olive Drab, Wolf Gray

6R1-NY324 \$88.00

High Speed Gear® Pistol TACO® Pouch Belt Mount 6R1-TP150 \$27.00

High Speed Gear® Rifle TACO® Pouch Belt Mount 6R1-TP573 \$32.00

High Speed Gear® Double Decker TACO® Belt Mount 6R1-TP572 \$44.00



VISIT US ONLINE



Shop our full selection of tactical and riot gear online at: galls.com/tactical-riot-gear



Black



BLACKHAWK!® CQB/Emergency Rescue Rigger Belt

NTQA-tested and recommended.

- 1¾" W webbing
- Rated at 7,000 lb

Sizes: S (28-34"), M (36-41"), L (41-51")

6R1-TE041 \$39.99

V-ring supports up to 7,000 pounds tensile strength

Black

Olive Drab

Desert Tan



High Speed Gear®

Securely hold an infinite combination of mags and other accessories with adjustable grips.

- 1000 Denier nylon construction
- Cordura® injection-molded polymer
- Maintains a positive, adjustable grip on its contents without additional securing systems

Colors: Black, ACU, Coyote, Gray, MultiCam® and Olive Drab Green

High Speed Gear® TACO® Mag Pouches

TACO® pouches adapt to multiple magazines

- Shock-cord lacing to lock almost any magazine into place
- VELCRO® brand is sewn on the interior for use with adhesive hook on mags
- Includes: MALICE™ clips to attach modular pouches to MOLLE/PALS style equipment

Made in the USA

Single and Double Stack: Holds a variety of multi-tools and flashlights securely.

4"H x 1¾"W x 1¼"D

6R1-TP630 \$27.90

Single Rifle: Holds certain radios, flash bangs, smoke grenades, 5.56 mm mags and 7.62 mm mags.

5"H x 3"W x 1¼"D

6R1-TP631 \$32.00

x2r Double Rifle: Double decker design allows the user to carry 2 mags in a single pouch double stacking the original TACO's®. Thin layer of HDPE to separate and lock any combination of mags in place.

5"H x 3"W x 2¼"D

6R1-TP633 \$44.00

Double Decker Rifle/Pistol: Combines a modular rifle and pistol mag pouch into one secure unit. Pouches also hold certain radios, flash bangs, smoke grenades, flashlights and multi-tools.

5"H x 3"W x 2¼"D

6R1-TP632 \$44.00



Single and Double Stack

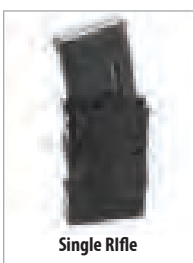

Single Rifle



x2r Double Rifle



Double Decker



Galls® Tactical Vest

Heavy-duty mesh vest has zipper front opening with utility pouches to carry all of your gear.

- Lace style adjustment
- Belt loops to secure vest
- Rear hydration pocket
- 6 M16/M4 magazine pockets/utility pouches
- 2 additional medium utility pouches and 1 small utility pouch
- Drag strap
- Adjustable sides

One size fits most

6R1-TE311 \$106.99



BLACKHAWK!® Dynamic Entry® Tool Backpack Kit C™

Additional tools and options for Entry Tool Backpack Kit!

- TE123 - 1 BoltMaster™
- TE441 - ThunderMaul™
- TE917 - 1 Active Shooter Hallagan Tool
- TE409 - 1 Manual Entry Tool Backpack

Made in USA/Imported

6R1-TE918 \$589.99

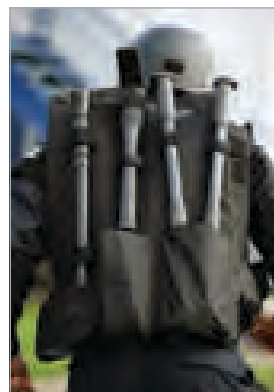

Store dynamic entry tools in a nylon backpack

BLACKHAWK!® Dynamic Entry® Tactical Backpack Kit™

Same as the above except TE448, Special Ops Hallagan Tool replaces TE917, Active Shooter Hallagan Tool. Made in USA/Imported. (Not shown).

6R1-TE449 \$581.99

Shipped to physical or APO/FPO addresses only

CamelBak® ThermoBak® 3L Hydration Pack

- 1000-Denier Cordura® exterior (except for Digital Woodland with 500-Denier Cordura exterior)
- External fill access to OMEGA™ HydroTitanium Reservoir with 100 oz capacity
- Low infrared reflective (LIRR) buckles, webbing and materials on Coyote and Army Universal Camo models provide an edge on the battlefield during night ops
- Quick-release shoulder straps unclip and stow away inside built-in pocket
- Integrated hook-and-loop strips for nametags and badges
- Front zippers allow easy access to OMEGA™ external access port for easy filling, cleaning and ice addition
- D-ring attachment points to add to load-bearing vest



Black



Black

Coyote

MultiCam®

6R1-LE346 \$72.99



Telesteps® Tactical Ladder

This lightweight ladder is constructed of aircraft-grade aluminum for durability and is lighter than most traditional ladders at 23 pounds. Easily transport this compact ladder once collapsed to an impressive 2½ feet in length.

- Strong construction without the weight of conventional ladders
- Aircraft-grade aluminum construction for durability
- Quickly extends when needed
- Engineered for tactical uses
- Wide rungs make climbing easier
- 300 lb rating

16'L (extended), 2½'L (closed). 23 lbs

6R1-TP362 \$319.79





Tactical



CBRN



Safe. Secure. SURVIVAIR.

Survivair® Opti-Fit™ Gas Masks

Developed specifically for tactical, NBC and riot-control first responders.

- NTOA-tested and approved; ANSI Z87.1-1989 (for lens); (G) NIOSH-approved with TE547 (below) (H) NIOSH-approved with TE549 (below)
- Unobstructed view with scratch resistant polycarbonate lens that's distortion free
- Three-position canister mounting; right, front, left
- Soft silicone facepiece offers comfortable fit
- DIN threaded 40mm connectors
- Five-strap silicone head harness
- CBRN model has drink tube for hydration in contaminated environments

Sizes: S, M, L

Description	Item	Price
Tactical	6R1-TE548	\$172.99
CBRN	6R1-TE546	\$284.19
Tactical Canister	6R1-TE549	\$65.99
CBRN Canister	6R1-TE547	\$64.99



MSA

MSA Advantage 1000 Gas Mask

NIOSH-approved and loaded with all the features you're looking for.

- High-carbon rubber
- Molded noseclip for a better, more comfortable seal
- Six-point adjustable nylon head harness
- Bayonet canister fasteners for easy on/off
- Wear 2 canisters for extra protection
- Canisters fit on either side to accommodate right- or left-handed shooters
- 1 cartridge included (other cartridges sold separately below)

Sizes: S, M, L

6R1-TE057 \$479.99

Replacement Cartridges 6R1-TE071
Single \$63.99/ea
Case \$389.35/6pk



MSA Millennium™ Gas Mask

Flexible, one-piece polyurethane lens offers wide field of vision.

- NIOSH-approved, CBRN-certified
- Lens is bonded to high carbon rubber facepiece
- Easy weapon sighting from either shoulder
- Drinking tube permits fluid intake in contaminated environment
- Canisters fit on either side

Sizes: S, M, L. Cartridges sold separately below

6R1-TE319 \$587.99

Cartridge 6R1-TE201 \$71.99+
CBRN Filter 6R1-TE306 \$76.99



+ Visit us online for pricing on additional options.



Regular Pouch
11"H x 9"W x 5"D



Large Pouch
14"H x 10"W x 8"D



Galls® Gas Mask Pouches

Made of Cordura® nylon with felt lining in main pouch. Comes with removable belt strap and drop-leg strap. D-rings at the bottom of each pocket for securing additional equipment. Two outside pockets with VELCRO® brand closures.

Regular Pouch

- 14"H x 9"W x 5"D
- Pocket: 5"H x 4"W x 2"D

6R1-TE210 \$43.69

Large Pouch

- 14"H x 10"W x 8"D
- Pocket: 6"H x 5"W x 4"D

6R1-TE242 \$53.59



Both pouches come with removable belt strap and leg strap



BLACKHAWK!® Omega Gas Mask Pouch

The Omega® drop leg gas mask pouch can be worn on the leg or on the belt. Both the belt hanger and the leg strap are fully adjustable and removable. Also comes with a removable shoulder strap.

- Made of 1000 denier Nyteon® nylon lined with closed cell foam
- Fully adjustable and removable belt hanger and leg strap
- Padded back for comfortable extended wear
- Outside utility pouch

Black. 10"H x 6½"W x 4"D.
1 lb, 3 oz

6R1-TE080
\$65.99



Questions?

Our knowledgeable and helpful customer service representatives are available Monday-Friday 8:00 a.m. - 9:00 p.m. ET. Call 800.477.7766 to place an order, ask a question or learn more about our products.

for Riot Control

NEW



Galls® Civil Disturbance Riot Scene Kit

We've packaged the essential gear you need for crowd management and personal protection. Kit includes:

- Safariland Flex-Cuffs Restraints (10 Pack) (RS015)
- Galls Gas Mask Pouch (TE210)
- Galls Tactical Team Bag (BG135)
- Galls Shin Guards (TE222)
- Gall Gear Tactical Elbow Pads (TE035)
- Galls Upper Body Protection System (TE265)
- Galls Elite S.W.A.T. Gloves (GL389)
- Premier Crown 906 Riot Duty Helmet (TE023)

For specific details on the individual components included in the kit, visit galls.com

6R1-TE153 \$355.29+ SAVE \$92.93
\$448.92 if purchased separately



For more information on the Galls® Tactical Team Bag, See p. 227



Paulson™ Convex Shields

Smaller shield allows you to go straight through cell doors during dangerous cell extractions. Larger shield provides more coverage for riot situations.

- Polycarbonate
- Features a molded plastic handle to prevent electric shock
- Shipped via ground only

Size	Weight	Item	Price
36" x 20"	6 lbs	6R1-TE142	\$159.89
48" x 24"	8.8 lbs	6R1-TE075	\$179.49



Head to Knee



Concave shape curves inward to protect holder

Upper Torso



Paulson™ Heavy BS-9 Shield

When you need maximum protection in a riot situation grab the BS-9.

- Made of heavy duty .250" thick polycarbonate
- Ergonomic handle which allows one or two handed use
- Handle and breakaway strap are dielectric to prevent electrical pass through and can be reversed for right or left handed use
- Wide nylon arm strap is easily adjustable while in use
- USA military spec V-50 rated

Titles: CORRECTIONS^(X), MILITARY POLICE^(X), POLICE^(X), SHERIFF^(X), plain. 48"H x 24"W. 14 lbs

6R1-TP211 \$223.59



Paulson™ Concave Riot Shields

Lightweight and in sizes to protect torso or full head to knee. Two-piece breakaway strap with a molded dielectric handle to prevent electric shock.

(TE076) 5.5 lb,
(TE197) 10 lb.

Titles: POLICE^(X), SHERIFF^(X) or CORRECTIONS^(X), plain

Description	Size	Item	Price
Upper Torso	36" x 20"	6R1-TE076	\$142.79
Head to Knee	48" x 24"	6R1-TE197	\$182.29

Shipped via ground only

VISIT US ONLINE

Shop our full selection of tactical and riot gear online at:
galls.com/tactical-riot-gear

(X) Visit us online for restricted item info.

Outershell and steel grid protect the officer from impact



906 Without Steel Grid

Protect Yourself



JCR100 With Steel Grid

Premier Crown® Helmets

- Meets or exceeds NIJ 0104.02 standard for riot helmets
- Semi-resilient polystyrene foam liner absorbs heat
- Double D-ring fastener provides strength and slip resistance

906 Riot Duty Helmets

Detachable face shield protects the officer's eyes.

- Polycarbonate alloy outershell with dull finish
- Liner covering made of self-wicking antimicrobial, antifungal material
- Foam nylon backing provides added durability and comfort
- Includes: Snap-on nape pad and plastic chin cup for added comfort

Without Steel Grid: Black. Sizes: S, XL, Jumbo. 3.2 lbs

6R1-TE023 \$134.59

With Steel Grid: 1/8" diameter steel wire with black nylon coating and welded joints for strength and safety. Black. Sizes: S/M/L, XL and Jumbo. 4 lbs

6R1-ZA1465 \$195.99



JCR100 Riot Duty Helmets

Helmets provide clearance on sides to accommodate a radio transmitter and receiver, plus sufficient clearance for use over gas mask.

- TacElite TCM™ fiberglass shell for high-impact, abrasion and penetration resistance
- Molded ABS inner liner for easy cleaning
- Interchangeable sweat-wicking sizing comfort pads
- Optically clear, 1/8" thick face shield with pivot system for up and down positions

Black. Sizes: S, M and L/XL. Viewing area: 23/4" x 8 1/2"

Without Steel Grid: 3.3 lbs

6R1-ZA1136 \$200.59

With Steel Grid: Wire guard is form fitted to match radius of face shield and is attached by four heavy-duty nylon clips. 4.1 lbs

6R1-TE786 \$232.29



Elbow

Knee



Galls® Gear Tactical Pads

Galls Gear Tactical Pads designed to offer protection and comfort. Pads are constructed of 1/2" foam and nylon shell with rubber anti-slip cap and adjustable VELCRO® brand straps. One size fits all.

Description	Item	Price
Knees	6R1-TE036	\$10.69/pr
Elbows	6R1-TE035	\$11.59/pr

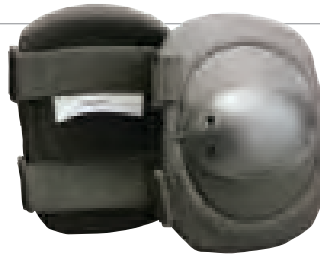

BLACKHAWK!® Advanced Tactical Elbow Pads

Elbow pads that spell protection and comfort.

- 600 denier nylon shell
- Non-slip flexible molded polyurethane cap
- Closed cell foam padding provides shock resistance and minimal moisture retention
- Hook-and-loop elastic straps

One size fits all. Colors: Black, Green, Olive Drab, Tan

6R1-TE537 \$17.99/pr



BLACKHAWK!® Advanced Tactical Knee Pads

Dual injection-molded flex cap bends with you!

- 600 denier nylon shell
- Closed cell foam padding
- Padded side extensions for added comfort and improved strap positioning
- Hook-and-loop elastic straps

One size fits all

6R1-TE577 \$25.99/pr

Galls® Drop Leg MK-9 Defense Spray Holder with Utility Pouch

Sturdy, durable two-piece construction.

- 1000 denier nylon.
- Non-slip lining prevents sliding
- Adjustable flap with VELCRO® brand
- Secondary buckle closure
- Small utility pouch on side for knife, pen or wipes

6"H x 2 1/4"W x 2 1/2"D

6R1-NP421 \$43.69



From Impact



Galls® Advanced Protection System

This system offers greater freedom of movement.

- Hydration pocket with routing grommet for tube
- Closed cell breathable foam with Z-Cool™ moisture management lining
- Adjustable, removable groin protector
- Hard shell shoulder protector
- Lower back extension to protect tailbone
- Utility pocket
- VELCRO® brand to secure ID holders on front, back and shoulders (TE299, sold separately)
- Comes with nylon carry bag

Sizes: M (38-40), L (42-44), XL (46-48), 2X (50-52).

Note: when measuring for size, be sure to wear any equipment such as uniform shirt, body armor or other gear you normally wear

6R1-TE316
starting at **\$136.69+**



+ Visit us online for pricing on additional options.



Damascus FlexForce™ Riot Control Suit

Riot suit with substantial protection from blunt force trauma that doesn't sacrifice fit and comfort.

- Elektrum XP8™ hard shell panels cover chest, back, forearm, thigh and knees
- Front and back hardshell panels have modular flex, for needed mobility
- Forearm guard has more flexible elbow
- Knee/shin guard has non-slip surface
- Easy to get in and out of quickly
- Comes in large nylon bag, for storage and transport

Sizes: M/L (38-46), XL (46-52), 2X (52-56)

6R1-TE583 \$405.99

ID Tag Sets: POLICE^(X), SHERIFF^(X), CORRECTIONS^(X)

6R1-TE034 \$9.39



(X) Visit us online for restricted item info.

I.D. Tag

Four tags, one for each shoulder, one for front and one for back. VELCRO® brand backing. Titles: POLICE^(X), SHERIFF^(X), CORRECTIONS^(X)
Colors: Black lettering on silver reflective background.

6R1-TE299 \$10.89



Galls® Upper Body Protection System

Durable, dark gray EVA foam and plastic plates encased in black ribbing for blunt trauma protection (no ballistic or stab capabilities).

- NTOA-tested and recommended
- Hydration pocket and 3/4" tube grommet inside back panel
- Adjustable arm padding
- Improved 2" side strapping for adjustability and comfort
- Larger area for reflective ID tags (TE034, sold separately below) on front and back
- Available in Regular and Long lengths for additional coverage: Regular length protects shoulders, chest and ribcage, long is 5" longer than regular and extends to waist

2 lb. Sizes: M (38-40) Reg/Long, L (42-44) Reg/Long, XL (46-48) Reg/Long, 2X (50-52) Reg/Long, 3X (54-56) Reg/Long. Note: When measuring for size, be sure to wear any equipment such as uniform shirt, body armor or other gear you normally wear

6R1-TE265 starting at **\$86.29+**

I.D. Tag

Two tags, one for front and one for back.
Titles: POLICE^(X), SHERIFF^(X), CORRECTIONS^(X)
Colors: Black lettering on white background.

6R1-TE034 \$9.59



Damascus IMPERIAL EVA Upper Body and Shoulder Protector

Made to protect the shoulders, back, chest and groin without limiting combative movement.

- Non-ballistic
- Lightweight cellular EVA foam pad design for maximum movement and protection
- Neck-roll features 40mm high-density sponge foam
- Shoulder pads with hard shell plastic inserts and foam padding
- Adjustable reinforced straps
- VELCRO® brand areas to secure ID Nameplates (sold separately)

2 lbs. Sizes: M (38"-42"), L (42"-46"), XL (46"-52"), 2X (52"-56"), 3XL (56"-60")

6R1-ZA1132 \$111.99



Spike and Knife Threat Protection



Point Blank Spike Vest

The Point Blank Spike vests are designed to help corrections officers against spikes, shanks and other potentially lethal handmade weapons.

- Point Blank Spike vests (Spike 1, Spike 2 & Spike 3) all comply with NJ Standard 0115.00
- Lightweight design means added comfort
- Flexible design contours to the body, allowing increased freedom of movement and mobility
- Self Suspending Ballistic System™ prevents rolling and sagging of protective stab panels
- Durable outer carrier is made of a 65% poly/35% cotton soil resistant fabric
- Trauma plate pockets on the front and back accommodate a 5" W x 8" H or 8" W x 10" H trauma plate
- Removable 2" side straps allow for easy 8-point adjustability

Sizes: see p. 356 for the How-to-Measure Chart. Areal Density: Spike 1-.28 lbs, Spike 2-.44 lbs, Spike 3-.56 lb

Description	Item	Price
Spike 1	6R1-BP716	\$512.59
Spike 2	6R1-BP717	\$598.89
Spike 3	6R1-BP718	\$685.19



PACA® Thrustguard Tactical Stab Vest

Made of Cobalt alloy, Kevlar® and open cell, high recovery foam.

- Complies with NJ 0115.00 Standards; Meets Spike 3 and Edged Weapon 3
- Helps provide protection from stab wounds
- Delivers unparalleled protection for high-risk cell extractions and riots
- Adjustable abdominal belt with protective cover flap



Black. Made in USA. Sizes: see p. 356 for the How-to-Measure Chart

6R1-BP001
\$893.19



PACA® Blade Plates

Instantly adds protection against sharp-edged weapons. Just insert the Blade Plate into your concealable vest's trauma plate pocket.

- Provides Level II sharp-edge weapon protection when worn with a Point Blank or PACA ballistic or spike-resistant vest
- EFH stainless steel and polymer construction
- 0.025" thick

Description	Weight	Item	Price
5" x 8"	4.1 oz	6R1-BP707	\$65.99
8" x 10"	7.4 oz	6R1-BP709	\$76.19
10" x 12"	10.5 oz	6R1-BP710	\$81.19

Largest Inventory

We know that you need your gear fast, so we offer in-stock availability on key items and more than 360,000 items you need and use everyday. Centrally located in the U.S., our distribution center offers nationwide delivery.



PACA® Cell Extraction Suit

Reduce the risk of injury during cell extractions. Provides maximum blunt trauma protection, this padded vest also offers an unprecedented level of maneuverability and functionality.

- One-piece collar, shoulder and bicep protection system
- Removable split collar design
- High-density foam padding
- Adjustable side-wing closure system
- Multifaceted shoulder strapping system
- Retractable groin protector with integrated thigh strapping system
- 3M™ Scotchlite™ CORRECTIONS title and size on front for fast identification
- Shoulder pocket accepts 5" x 8" protection

Black. Sizes: S-3X

6R1-TE879 \$922.69



VISIT US ONLINE

Shop our full selection of stab armor online at: galls.com/stab-armor



Max Pro™ MPA Gunfighter Helmet with Rails and NVG Shroud

Manufactured utilizing advanced thermoplastic aramid and glass fabric composites for higher ballistic protection at a lighter weight than the specification of the U.S. Military ACH helmet.

- Meets or exceeds NIJ Level IIIA ballistic standard for penetration
- Meets a minimum of 650 mps V-50 for 17 grain tested according to STANAG 2920
- Higher cut allows for a better, unobstructed view and increased hearing capability
- Tubular poly webbing retention system with double bat tacked stitching
- Neck trim line provides maximum protection with uninhibited movement
- Neoprene rubber trim and protected with scratch resistant non-reflective flat paint
- Easy on/off quick release and split leather chin strap
- Variable thickness, 7 impact absorbing pads can be adjusted or removed
- Pad thickness sizes: standard size 6 at ¾" or optimal size 8 at 1"

Sizes: S-XL. Weight: starting at 2.4 lbs (small). Includes: Wilcox NVG mount and side accessory rails

6R1-TE328 \$636.99



Higher cut for increased hearing

Max Pro™ IIIA Helmet with Face Shield

Ballistic protection with attached face shield.

- Complies with Level IIIA NIJ 0106.01 requirements. US MIL 662F V50 650 m/sec; 397 Low Velocity Impact
- Contoured shell design
- Adjustable, universal harness
- Face shield is made of durable Paulson
- DKSH, 150S-HM for superior clarity and protection
- Face shield designed to accommodate use of a gas mask

Sizes: S (up to 21¼") M (21¼"-22½") L (22½" - 23½") XL (23½"+)

6R1-TP154 \$374.99

Without Shield **6R1-TE622 \$256.99**



Max Pro™ Combat Helmet

Designed after the military ACH pattern helmet to increase vision and hearing capability over the PSAGT style.

- Tested to meet a minimum of 650 mps V-50 for 17 grain STANAG 2920 protocol. Complies with and exceeds Level IIIA NIJ 0106.01 requirements
- Advanced thermoplastic aramid and glass fabric composites
- Provides high-level protection at weight less than specifications for the U.S. Military ACD Helmet
- Lined with impact-absorbing ¾" pads to protect against blunt force trauma

Sizes: S (up to 21¼") M (21¼"-22½") L (22½" - 23½") XL (23½"+)

6R1-TP265 starting at \$319.99+



Black

Olive Drab

Coyote Tan



Visit us online for pricing on additional options.



Black



NEW

\$253⁷⁹

Paraclete® PASGT Style IIIA Ballistic Helmet

MICH style provides a balance of protection and mobility.

- Meets NIJ 0108.01 Level IIIA standards
- Aramid, thermoplastic
- Sweat-wicking material in the pad system helps to prevent moisture buildup
- Four-point adjustable attachment system with supportive neck pad
- Compatible with chem/bio hazard masks
- Add TE562 Paulson Face Shield to convert your helmet for riot use

Sizes: S-XL

6R1-TP782 \$253.79

Black

Olive Drab

United Shield International

United Shield Sprint IIIA Operators Helmet

Special operations helmet is designed with Integrated night vision goggle mount technology, allowing for a universal goggle fit.

- Complies with Level IIIA NIJ 0106.01 requirements and meets 17 grain STANAG 2920 protocol and USMIL fragmentation standard
- Universal night vision goggle mount
- Factory fitted Picatinny side rails
- Adjustable harness and pad liner for stability

Sizes: S-XL

6R1-TP316 \$815.49



VISIT US ONLINE



Shop our full assortment of ballistic helmets online at: galls.com/ballistic-helmets

Be Prepared for Active Shooter Scenarios

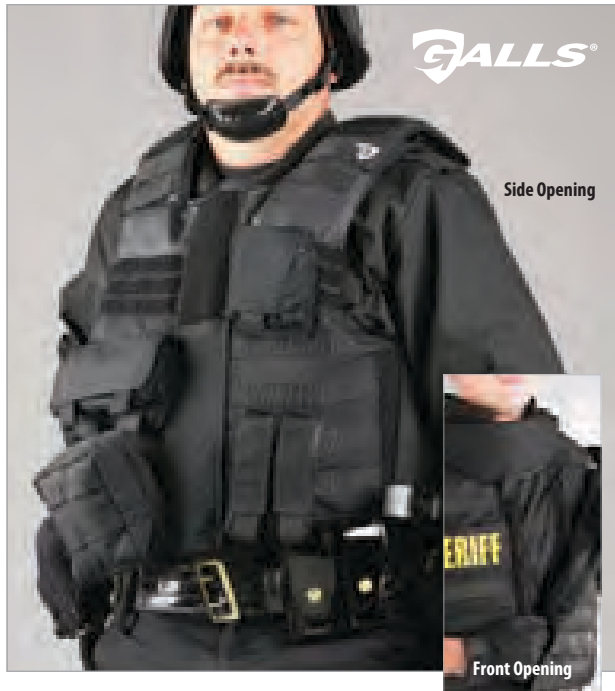

Galls® SMG Ballistic MOLLE Vest

CORDURA® nylon and Aramid with optional Level IIIA protection.

- Complies with *NIJ 0101.06 armor standards*
- Areal Density: 1.54 lbs/ sq ft
- MOLLE rack front and back accommodates pouch placement in any location
- Front and back armor plate compartments
- Side opening for full access; VELCRO® brand side straps for infinite size adjustments
- Includes 5 pouches: double mag, utility, shotgun shell, radio and single handcuff
- Optional Level IIIA neck, bicep and groin protectors snap into place for added coverage (sold separately below)

Made in the USA. Sizes: S (32-34), M (36-38), L (40-44), XL (46-48), 2X (50-52)

Description	Item	Price
Side Opening	6R1-BP463	\$1141.49
Front Opening	6R1-BP755	\$1086.99
Neck Protector	6R1-BP219	\$169.29
Bicep Protector	6R1-BP218	\$270.99
Groin Protector	6R1-BP216	\$141.69

Galls® MOLLE Rack SMG Label Set

Identify yourself with a bright MOLLE-compatible label that can be repositioned whenever you rearrange your rig.

4"H x 5"W. Black with white letters: POLICE^(X), SWAT^(X).

Black with yellow letters SHERIFF^(X)

6R1-BP332 \$55.39



Paraclete® Alpha-1 Tactical Vest Armor System with AXIIIA Ballistics

High-performance ballistic protection integrated into a fully functional and scalable design to adapt to any condition.

- Complies with *NIJ 0101.06 armor standards*
- Selective Point Release System (SRS) allows you to select the location of releases
- Front and back, bottom-loading plate pocket accepts 8"x10" or 10"x12" plates

Colors: Black, Coyote, Olive Drab Green, MultiCam®, Ranger Green

6R1-BL094 \$4551.69



Paraclete® Level IV Triple Curve Ceramic Plate

Shooter's cut with a triple curve design for increased comfort.

- *NIJ 0101.04 certified*; Threat Level IV
- Manufactured using ceramic and aramid
- Tested to .30 caliber 166 grain armor piercing round

Black. 10" x 12"; 8.15 lbs

6R1-BP633 \$202.99



Max Pro™ Level IV Multi-Hit Ballistic Plates

Thermoplastic Composite bonding and Alumina Ceramic panel construction for ballistic performance and integrity retention.

- *NIJ Certified Level IV; NIJ 2005 Interim requirements*
- Multi-hit rated through independent testing at certified test lab site
- Front and back plate styles

11½"H x 10"W x 1"D. 7.5 lb (front). 8 lb (back)

\$208.33

Description	Item
Front	6R1-TE770
Back	6R1-TE897

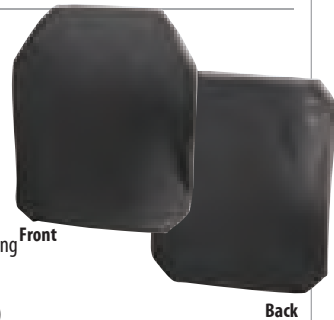

Active Shooter Armor Kit

We've packaged everything you need all into one of our best-selling bags so it's easy to be prepared and to save money too! Kit includes:

- Max Pro Level IV Multi-Hit Front Ballistic Plate - TE770, a \$208.33 value
- Max Pro Level IV Multi-Hit Back Ballistic Plate - TE897, a \$208.33 value
- Max Pro Vector Ballistic Plate Carrier- TE070, a \$74.99 value
- Max Pro Ballistic Helmet - TE622, a \$300.00 value
- Galls StreetPro Plus Gear Bag - BG185, a \$69.39 value

6R1-TP254 \$729.94 **SAVE \$130**

\$861.04 if purchased separately



Equip Your Team with Maximum Protection



APSPIS Bellator



Bellator



Phalanx



Paraclete Ballistic Shields

Level IIIA+ protection with less weight for improved mobility.

- Meets NIJ 0108.01 IIIA+
- Hybrid composite ballistic material reduces weight
- Agile performance for handgun deployment
- Larger, more functional, view port



APSPIS Bellator: The ideal size for everyday carry in the trunk of your patrol car.

30"H x 20"W. 10.3 lbs

6R1-BL046 \$2101.99

Bellator: Weapon mount platforms on each side enhance the officer's ability to safely present their weapon from behind the shield and provides better peripheral vision.

36"H x 24"W. 16 lbs

6R1-BL045 \$2378.69

Phalanx: Innovative V-shape increases strength and diverts fire away from the center. Unique weapon mount platforms on each side provide multiple options for weapon presentation.

36"H x 24"W. 20 lbs

6R1-BL044 \$2715.19

(X) Visit us online for restricted item info.



PROTECH® Ballistic Intruder Entry Shield with Lights

Two high-intensity halogen lights work as tactical advantage by blinding assailants.

- Threat Level IIIA tested to NIJ 0108.01
- Handle attachment eliminates weak spots often found in conventional ballistic shields
- Horizontal ambidextrous handle allows longer use without fatigue
- Enlarged 4"H x 18"W laminated, curved viewport
- Padded forearm rest
- 3" clearance between shield and handle to protect against injury from impacts
- Pressure switch activates lights when on/off switch is on

34"H x 20"W. 16.5 lbs. Titles: POLICE^(X), SHERIFF^(X) and plain

6R1-TE084 \$3075.49



PROTECH® Ballistic Entry Shields

All shields except Patroller have an extended overlapping (front and back) viewport, designed for multi-hit capabilities. Also has curvature for optimum peripheral vision.

- Complies with Level IIIA NIJ 0108.01 requirements
- Constructed of penetration-resistant, energy-dispersing ballistic Spectra Plate covered by a lightweight projectile-absorbing metal alloy skin
- Comfortable ambidextrous handle

Titles: POLICE^(X), SHERIFF^(X), SWAT^(X) and plain

Description	Size	Weight (lb)	Item	Price
Patroller	24"H x 18"W	8.5	6R1-TE189	\$1146.99
Mighty Mite	30"H x 18"W	14	6R1-TE190	\$1705.19
Entry Two	48"H x 24"W	24	6R1-TE192	\$2435.99
Intruder G2	34"H x 20"W	21	6R1-BP966	\$3359.69

Shop our selection of active shooter bags, on p. 224.

Ordering online? Use your **PROMOTIONAL CODE** from the back cover

800.477.7766 • galls.com

349



Flying Cross® Aeroshell™ Vest Carrier

Stay cool and comfortable with the Flying Cross Aeroshell Vest Carrier. This external carrier houses your body armor within its own carrier, all while maintaining the professional appearance.

- Breathable mesh lining allows continuous air flow, keeping you cool and dry
- Front-to-back, VELCRO® brand closure system provides adjustability and a secure fit
- Innovative adjustment system for a fast, easy custom fit

LAPD Navy. Sizes: XS-3X, see p. 356 for the How-to-Measure Chart

Desc.	Material	Item	Price
Command	Polyester	6R1-BL358	\$79.99+
Deluxe Tropical	70/28/2 Poly/Rayon/Lycra	6R1-BL358	\$94.99+
Deluxe Tactical	65/35 Poly/Rayon	6R1-BL356	\$99.99+
Justice	75/25 Poly/Wool	6R1-BL357	\$99.99+

Check out the matching Polyester Hybrid Performance Shirts on p. 87



V1
Dark Navy

Looks like your uniform shirt, but contains your regular body armor carrier inside

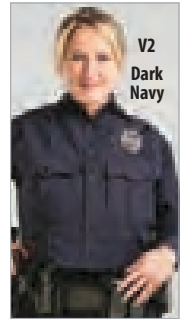

V2
Dark Navy

[+](#) Visit us online for pricing on additional options.

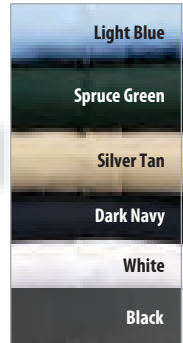

Elbeco™ TexTrop External Vest Carriers

The innovative design of this vest allows it to house your current vest in the body armor manufacturer's original concealable carrier. No need to remove or reposition panels – just insert your entire carrier. This external vest carrier meets the need for a more professional look while providing the protection you need.

- Polyester material with Nano Moisture-Wicking Coolest Comfort Technology for permanent moisture management
- Large hidden document pocket under left chest and 2 document pockets under each chest pocket with hook and loop closures
- Designed to house most body armor manufacturer's vest in its existing concealable carrier with interior shoulder openings under straps for easy insertion
- Tunnel loops on inside lining accommodate VSS1 suspension system (NY019)
- Fully functional shoulder straps with mic opening
- Functional dual pleated front pockets with scalloped flaps with removable button option and hook and loop closure
- Fully fused front with stitched creases and front placket with buttons
- Badge tab eyelets above left chest pocket supported by fusing
- Perfect match to Elbeco Undervest Shirts
- Mic loop on front placket

Sizes: S-3X. Sizes: see p. 356 for the How-to-Measure Chart. Colors: (BP880) all. (BY147) Dark Navy

V1 TexTrop: Back-to-front hook and loop closure system for tightening and releasing the vest

6R1-BP880 starting at \$82.99+

V2 TexTrop: Unique cummerbund-style stretch waist with front-to-back side hook and loop closure system.

6R1-BY147 starting at \$94.99+



Navy



Point Blank Tailored Armor Carrier

This carrier is designed to hold your armor panels, but allows you to wear the armor over your uniform shirt.

- Easy on/off design provides greater comfort during a long shift
- Durable polyester outershell with soft polyester/cotton twill lining
- 5"W x 8"H and 8"W x 10"H trauma plate pockets are built into the front and back outershell
- Adjustable side straps
- 2 front bellowed pockets
- Badge and name tag tabs
- Built-in mic holder
- Fits all Galls® and PACA vest panels

Sizes: S-XL, see p. 356 for the How-to-Measure Chart

6R1-BP448 \$178.69

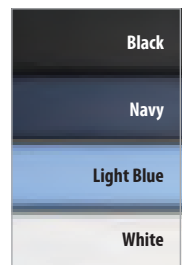

External Carriers to Meet any Situation

Galls® Carriers are Compatible with All Galls® Ballistic Panels

- VELCRO® brand strap inside carrier secures it close to body
- VELCRO® brand closures
- Mic clip-ons on left and right shoulders

Black. Sizes: S/Reg (38-40), M/Reg or Lng (42-44), L/Reg or Lng (46-48), XL/Reg or Lng (50-52). Title and Letter color choices: POLICE^(X) comes in white letters. SHERIFF^(X) and DEPUTY^(X) come in gold letters

(X) Visit us online for restricted item info.



Galls® Cordura Tactical Carrier

- Title panel on the front and back.
- Water-resistant Cordura® nylon construction
- 5 utility pockets to carry gear
- Comes with removable, identification panel on front and back

6R1-BP166 \$178.49



Galls® Tactical Carrier

- Turn your concealable vest into a tactical vest, making it more functional by adding armor plates and MOLLE pouches.
- Wear as an outer vest
- MOLLE system compatible
- Front and back compartments for 10"W x 12"H plates
- Includes removable, identification panel

6R1-BP368 \$243.39



Black

Point Blank Guardian Ballistic Vest Carrier

The Guardian combines the versatility of a front opening vest with an advanced design which offers maximum protective coverage.

- Adjustable shoulders and side area
- Center zipper, shoulder mic tabs, pin badge area VELCRO® brand name plaque
- Internal front and back plate pockets

Sizes: S-XL, see p. 356 for the How-to-Measure Chart

6R1-BL368 \$228.39

Black
Midnight Navy
Olive Drab Green
Ranger Green



Point Blank EMS Ballistic Vest Carrier

Accommodates all Point Blank, PACA and Galls concealable side-opening ballistic panels and feature better adjustability and mobility for overall great fit.

- Rugged nylon outer-shell for durability
- Adjustable shoulders and side straps for increased comfort
- Hi-Viz reflective EMS logo
- 2 reflective strips
- 3 pouches for gear

Navy. Sizes: S-XL, see p. 356 for the How-to-Measure chart

6R1-BP822 \$184.69

Allow 4-6 weeks for factory delivery



Elbeco™ Suspension System

Redirects weight of duty belt off of hips and lower back, giving the belt a feeling of weightlessness

- Uses innovative quick-clip system to allow for easy donning and doffing
- Free-floating straps glide inside vest tunnels, allowing wearer full range of motion
- Stretch suspender system with 100% recovery allows for easy adjustment
- Best results when integrated into V1 External Vest Carrier
- Requires no modification of existing trousers, duty belt or vest
- Helps anchor vest carrier in place

6R1-NY019 \$28.50



Locker



Deodorizer

Hanger

Body Armor Care Kit

Includes body armor locker (BP198), deodorizer (BP076) and body armor hanger (BP373).

6R1-BP377 \$50.79 SAVE 33%
\$75.17 if purchased separately

Body Armor Locker: Allows vest to dry before storing in locker. 4"H x 23"W x 20"D. 5.6 lb

6R1-BP198 \$44.59

Vest-Guard™ Deodorizer: Safe, non-toxic and easy to use. Spray on and let dry. 16 oz

6R1-BP076 \$14.89

Body Armor Hanger: Supports the weight of tactical or concealable armor. Plastic. Black. Made in USA. 10" x 16". 9 oz

6R1-BP373 \$10.19



Just hook over your shirt collar and chill out



CoolCop

CoolCop® Body Armor Air Conditioning

The perfect solution for hot days on patrol. CoolCop attaches to your cruiser's AC vent and allows you to direct cool air under your body armor.

- Includes vent adapter and hose
- Choose CB model for all model years of the Ford Crown Victoria
- Universal model fits most vehicles including the Chevy Impala, Dodge Charger, Ford Explorer and Expedition
- Uses a variety of clips to attach to the louvers or edge of the vent

6R1-BP912 \$64.99

ArmorPUR™ Body Armor Deodorizer

ArmorPur Body Armor Deodorizer gets rid of armor odor.

- Safe and gentle non-bleach odor neutralizer spray for your body armor
- Spray the outer carrier, allow it to dry and odor is gone
- Also works great on your other gear, clothing and footwear

6R1-BP754 \$20.69



GALLS®



Galls® Soft Trauma and Hard Shock Plates

Without stand-alone ballistic protection.

Plate	Size	Item	Price
Soft	5"W x 8"H	6R1-BP183	\$36.59
Soft	8"W x 10"H	6R1-BP396	\$64.09
Hard	5"W x 8"H	6R1-BP182	\$36.59
Hard	8"W x 10"H	6R1-BP397	\$64.09

PARACLETE



Paraclete® Speed Plates

A lightweight polyethylene plate designed to be inserted into concealable body armor. Available in male and female designs. *Special threat tested to the NIJ 0108.01 standard.*

6R1-BP634	
5"W x 8"H	\$113.89
6"W x 8"H	\$119.09
7"W x 9"H	\$150.19

High-Performance Concealable Protection



Navy



Black



Survival Armor® Performance 6 Vests

The Performance 6 package is the answer to law enforcement's need for an economical, quality ballistic solution. With the Performance 6, quality does not have to be compromised by departments on a budget.

- *Special Threat Tested beyond new NIJ 06 Standard*
- VisiBALLISTICST viewport allows officers to inspect the wear of their armor
- Vertex moisture-wicking antimicrobial carrier system
- 5" x 8" soft trauma plate included
- Extra carrier (sold separately) available in Navy, Black, White, Tan, Brown, Olive Drab Green,

Colors: Navy, Black. Extra carrier (sold separately) available in Navy, Black, White, Tan, Brown, Olive Drab Green.

Sizes: see p. 356 for How-to-Measure Chart

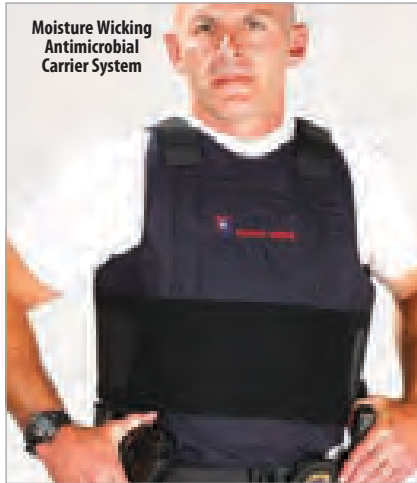

Moisture Wicking Antimicrobial Carrier System

Threat Level	Item	Price
II	6R1-BP261	\$451.49+
IIIA	6R1-BP262	\$519.99

Survival Armor Performance 6 Carrier **6R1-BP263 \$94.59+**

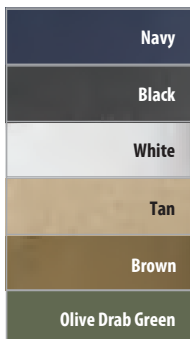

[+ Visit us online for pricing on additional options.](#)

Second Chance® Summit SMO1 with APEX® Carrier

The most flexible armor in the Second Chance armor line. This hybrid design provides Core Matrix® technology, high performance shielded aramids enhanced comfort and advanced stitching for ballistic performance.

- Complies with NIJ 0101.06 armor standards
- Made of Twaron Microlaminates and Gold Shield; APEX® microfiber carrier with anti-odor Xstatic® silver fiber which repels micro-organisms and reduces odor
- Front pocket fits 5" W x 8" H or 7" W x 9" H trauma plates
- APEX® carrier designed with Grip-Lok™ panel suspension system to reduce curling and wrinkling
- 4 and 6 point strap systems for maximum adjustability
- Standard with front and rear tails to reduce armor shifting

Made in the USA/Imported. Sizes: See p. 356 for How-to-Measure Chart

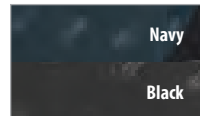

Threat Level	Areal Density (lb/sq ft)	NIJ#	Item	Price
II	0.85	BA200 05-SM01.1	6R1-BP493	\$1366.19
IIIA	1.15	BA-3A005-SM01	6R1-BP494	\$1463.69

Second Chance APEX Carrier **6R1-BP492 \$106.49**

VISIT US ONLINE



Shop our full selection of concealable body armor online at: galls.com/concealable-armor

EDW and Ballistic Protection



Black



Point Blank Alpha Ballistic Vests

Advanced, flexible and ultra-lightweight body armor by Point Blank. Protection weight is reduced by an average 25% per square foot.

- System met and exceeded FBI body armor test protocol requirements
- Complies with NIJ 0101.06
- Woven aramid and polyethylene UD
- Outlast® temperature regulating technology
- Waterproof ballistic cover
- Self-Suspending Ballistic System™ with eight-point adjustability
- Front and back plate pockets fit 5"W x 8"H or 8"W x 10"H
- Includes a 5"W x 8"H soft trauma plate

Made in the USA. Sizes: See p. 356 for How-to-Measure Chart

Threat Level AXII

- Areal Density: 0.63 lb/sq ft. Thickness: ¼"
- Smart-fabric technology helps keep you cool, dry and comfortable

6R1-BY573 \$984.59

with ThorShield: Electroshock weapon protection.

6R1-BY600 \$1045.49

Threat Level AXIIIA

- Areal Density: 0.87 lb/sq ft. Thickness: ¼"
- Smart-fabric technology helps keep you cool, dry and comfortable

6R1-BY618 \$1136.79

with ThorShield: Electroshock weapon protection.

6R1-BY599 \$1192.69

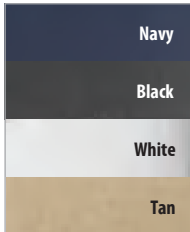

ThorShield™ Carrier with ECD protection



Black



Point Blank Vision with ThorShield™ Carrier

Point Blank vest meets NIJ standards and provides a patented Self Suspending Ballistic System™. All models now come with ThorShield™ lining that protects against EDWs.

- Complies with NIJ 0101.06 armor standards
- Soft inner surface resists the growth of odor-causing mold and mildew
- Front and back trauma insert pockets accommodate 5"W x 8"H or 8"W x 10"H trauma insert plate for additional protection
- 8-point adjustability for optimum comfort
- Internal 4" cummerbund stabilizes rear ballistic panel and helps prevent riding up when sitting
- Engineered with Outlast® Adaptive Comfort® Technology to help regulate body temperature
- Neoprene shoulder straps provide added comfort

Made in the USA. Sizes: See p. 356 for How-to-Measure Chart

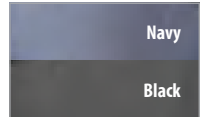

Threat Level	Areal Density (lb/sq ft)	NIJ#	Item	Price
II	0.63	AXII	6R1-BY627	\$974.39
IIIA	0.87	AXIIIA	6R1-BY815	\$1082.79

Extra Carrier (Navy, Black) **6R1-BP476 \$243.59**

ThorShield™ Electro-Muscular Disruption Resistant Technology

Law enforcement experts report an increase in the rate that officers are being shot with their own weapons, especially less-lethal energy arms. These authorities are recommending the use of apparel/devices that are resistant to weapons used in such attacks. ThorShield™ is a durable, lightweight, conductive material that effectively protects the wearer when hit in the vest with less-lethal energy weapons, such as TASER® devices and other electro-muscular disruption weapons.



VISIT US ONLINE

Shop more Point Blank Alpha carrier options at galls.com/brands/point-blank

Optimal Fit and Maneuverability



Point Blank HI-LITE™ Series Body Armor

The HI-LITE™ Body Armor Series from Point Blank represents the pinnacle of modern ballistic protection, offering many unique features designed to keep you both safe and comfortable. The patented Self Suspending Ballistic System™ connects the front and back ballistic panels with shoulder straps within the carrier, holding them up in place to prevent dangerous sagging and wrinkling.

- Meets Berry Amendment requirements
- Breath-O-Prene® shoulder straps to ensure optimal coverage at all times
- WIK-AWAY moisture-wicking inner material moves moisture away from the body and aids in the cooling process
- Removable shoulder and side straps provide 8 point adjustability for a better fit
- Carrier has front and back 5"W x 8"H or 8"W x 10"H trauma plate pouches
- Includes 5"W x 8"H trauma plate

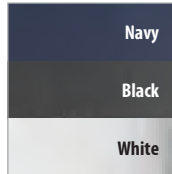

Made in the USA. Sizes: See p. 356 for How-to-Measure Chart

Threat Level	Areal Density (lb/sq ft)	NIJ#	Item	Price
II	0.79	SP+2LE	6R1-BP965	\$867.89
IIIA	1.14	FLXIIIA	6R1-BP953	\$938.89

Point Blank GNX Series Ballistic Systems

Hi-Lite Performance remains a hallmark of Point Blank's line of outstanding body armor. Specially designed to provide maximum maneuverability and comfort, these exceptionally lightweight, concealable vests offer unparalleled protection when paired with our industry-leading ballistic systems.

- GNX II complies with NIJ 0101.06 Level II armor standards
- GNX IIIA complies with NIJ 0101.06 Level IIIA armor standards
- Woven aramid/UD polyethylene
- Self-Suspending Ballistic System™
- Durable Water Repellent (DWR)
- Dri-Lex® moisture management system

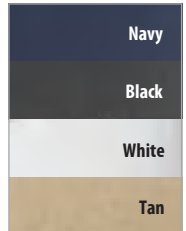

S-2X. Imported.

Threat Level	Areal Density (lb/sq ft)	NIJ#	Item	Price
GNX II	0.96	GNX II	6R1-BL496	\$674.99
GNX IIIA	1.18	GNX IIIA	6R1-BL285	\$862.79

VISIT US ONLINE

Shop our complete assortment of body armor, plates and accessories online at: galls.com/body-armor-ballistic-protection

Check out our selection of moisture-wicking under shirts starting on p. 46

Outfit Your Agency or Department

We can outfit your entire department – no matter how large or small. Our in-house customization, hemming and personalization services will keep your department ready for duty.

Concealable Protection



Black

Strapping system and external pouch that holds 5" x 8" or 8" x 10" trauma plates



Galls® LX Body Armor

Improved, next generation LX body armor is lighter and more flexible. Microfiber carrier with antimicrobial lining and a six-point strapping system for a customized fit.

- Complies with NIJ 0101.06 armor standards
- Extended coverage
- Front and back plate pockets to fit 5" x 8" and 8" x 10" trauma plates
- Six-point strapping systems for added comfort and adjustability
- Waterproof ballistic panel cover
- Microfiber carrier with anti-microbial lining
- Carrier has shirttails to help hold the vest into position

Made in the USA. Sizes: See left for How-to-Measure Chart

Areal Threat Density Level (lb/sq ft)	NIJ#	Item	Price
IIA 0.57	AIIA-2	6R1-BP958	\$730.79
II 0.73	AII-2	6R1-BP959	\$859.29
AIIIA 0.98	AIIIA-1	6R1-BP455	\$991.19
Microfiber Extra Carrier		6R1-BP462	\$120.79



Body Armor How-to-Measure Chart

Have another person measure your upper torso using a cloth tape measure. Wear proper attire i.e., T-shirt, service duty belt, etc.). Hold tape firm and level. For all measurements, round up to nearest whole number. Proper measurement ensures that edge of front and back panels will not touch duty belt or accessories while standing.

- Chest:** Measure around the fullest part of the chest, in a relaxed state, starting at the center.
- Waist:** Take a standing waist measurement, ensuring you measure across waist at its widest point. Generally, the widest point will be either approximately 2" above the duty belt or along the belly-button line.*
- Torso/Front Standing:** Measure from clavicle notch (collarbone) to approximately 1/2" above the duty belt.
- Torso/Back Standing:** Measure from the base of the collar (center of the back) to the top of a fully equipped duty belt.
- Torso/Front Seated:** Measure from clavicle notch to 1/2" above duty belt.

*If waist measurement is larger than chest measurement, select the size corresponding to the waist.
For females, please note the cup and band sizes for proper measurements

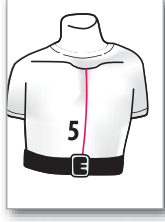

VISIT US ONLINE

Find more measuring information online at galls.com/Pages/how-to-measure

\$157.58 Value FREE



FREE!
Extra Carrier
(\$120.79 Value)



FREE!
Soft Trauma Plate
(\$36.79 Value)

without Compromising Coverage



Galls SE Body Armor
Starting at
\$393⁷⁹

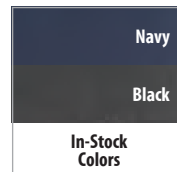

Galls® GL Body Armor

The ballistic panels provide extended coverage and are self-supported to prevent sagging.

- Complies with NIJ 0101.06 armor standards
- BP452 is made of Kevlar® XP and is special threats tested
- Six-point removable strapping system with adjustable VELCRO® brand for added comfort and adjustability; neoprene shoulder straps
- Waterproof ballistic panel cover
- Microfiber carrier has an antimicrobial lining to help control odor
- Carrier has shirttails to help hold the vest into position

Made in the USA. Sizes: See p. 356 for How-to-Measure Chart

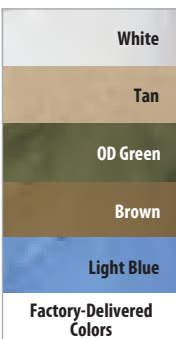

Threat Level	Areal Density (lb/sq ft)	NIJ#	Item	Price
GBIIA	0.73	GXIIA	6R1-BP960	\$568.39
GBII	0.89	GXII	6R1-BP961	\$671.49
KXPIIIA	1.14	KXPIIA	6R1-BP452	\$761.29
GXIIIA	1.24	GXIIIA	6R1-BP962	\$812.89

Extra Microfiber Carrier 6R1-BP462 \$120.79



Galls® SE Body Armor

An integrated carrier design with comprehensive protective coverage and enhanced mobility. The Self Suspending Ballistic System™ is comprised of neoprene shoulder straps and VELCRO® brand adjustability to provide you with a custom fit.

- Complies with NIJ 0101.06 armor standards
- Level IIIA meets US fragmentation tests for 2, 4, 16, 17 and 64 grain
- Extended coverage
- Waterproof ballistic panel cover
- Carrier has shirttails to help hold the vest into position
- Neoprene shoulder straps provide added comfort

Made in the USA. Sizes: See p. 356 for How-to-Measure Chart



Threat Level	Areal Density (lb/sq ft)	NIJ#	Item	Price
IIA	0.87	CIIA-3	6R1-BP432	\$393.79
II	1.13	CII-3	6R1-BP433	\$460.69
IIIA	1.5	LXIIIA	6R1-BP964	\$482.99

Extra Poly/Cotton Carrier 6R1-BP461 \$101.99

Everything you need – from A to Z

A

Accessories	
Apparel & Uniform	95-97, 133-137
Duty Gear	306-307
Flashlights	201
Shooting Accessories	336-339
Vehicle	258-263
ADC	242-244
Adventure Medical	238-241
AEDs	243
Aker	303, 304, 306
Alcohol Testers	314
ALS Kits	234
Ankle Holsters	304
ANSI & Safety	126-132
APPAREL & UNIFORMS	
ANSI & Safety	126-132
Bike Apparel	62-65
Class A	84-91
Class B	76-83
Class C & Casual	6-61
Customization	100-105
ID & Commendations	106-113
Ordering & Sizing	98-99
Outerwear	114-125
Outerwear Accessories	133-137
Specialty Uniforms	92-94
Stationwear	66-75
Uniform Accessories	95-97
ASP	
Batons	326-329, 333
Duty Gear	305, 321
Flashlights	192
Pepper Spray	333
Red Guns	335
Restraints	318, 322, 323, 324
Training	322, 334, 335
Athletic Footwear	168-183
Athletic Apparel	46-57
ATN	311

B

Badge Holders	111-113
Badges	109-110
Backpacks	222, 223, 225, 226
Bags & Organizers	220-229
Backpacks	222, 223, 225, 226
Clipboards	229
Customization	105
Duffles	222, 223, 225
Fire	251
Gear	220-221
Hard Cases	228
Medical	230-235
Seat Organizers	221, 263
Range Bags	224, 225
Rolling Bags	227, 228
Tactical	224-226
Trunk Organizers	263
Ball Caps	44-45
Ballistic Protection	348-349, 353-357
Accessories	352
Ballistic Plates	348
Carriers	350-351
Concealable Vests	353-357
Helmets	347
Shields	349
Stab Armor	346
Tactical Vests	348
Trauma Plates	352
Barrier Tape	210
Bates	146, 147, 152, 153, 158, 162, 163, 181, 187
Batons & Accessories	326-329
Batteries	201
BDUs	76-77
Bianchi	284, 287, 292, 296
Belts	
Casual	40
Concealment	306-307
Dress	41

Leather Duty	289-295
Nylon Duty	296-301
Shirt Garter	95
Synthetic Duty	289-295
Tactical	41, 340
Trousers	40, 306-307
Belt Slide Holsters	301, 303
Bike Apparel	62-65
Binoculars	312-313
BlackBox	322
Black Diamond	252, 253
Blackinton	106, 107, 108, 109
BLACKHAWK!	
Duty Gear	288, 289, 297, 298, 299, 300, 301
Tactical	340, 341, 342, 344
Blankets	241
Blazers	92
Blood Pressure Kits	242, 243
BLS Kits	232-233
Blue Guns	335
Body Armor	346-357
Accessories	352
Ballistic Plates	348
Carriers	351-351
Concealable Vests	353-357
Helmets	347
Shields	349
Stab Armor	346
Tactical Vests	348
Body Cameras	308-309
Boots & Shoes	
Accessories	184-187
Athletic	168-183
Casual	165-168, 172-173
Duty	138-157
Dress	162-163
Fire	252-253
Insoles	184
Non-Metallic	145, 146, 148-151, 153, 162, 164, 168, 176, 177, 181, 183
Oxfords	140, 155, 162-168, 170, 172, 173, 179, 183
Quarterboots	139-141, 143-145, 148-153, 155, 156, 160, 161, 163-166, 168-171, 174, 176-179, 181, 183
Safety Toe	141, 144-146, 148, 150, 152-153, 155, 157, 160, 161, 164, 168, 179, 183
Socks	184-187
Specialty	158-167
Waterproof	141, 142, 144-146, 148-157, 158-160, 165-169, 175, 177-179, 181, 183
Women's	139, 143-144, 146, 147, 153, 164, 167, 168, 170, 171, 172, 173, 179, 180, 181, 183
Work	160-161
Zipper	139-153, 156-159, 176-181, 183
Boxers	48, 49, 55
Bra	47, 55
Breathalyzers	314

Bullard	250, 255
Bushnell	312
Button Replacement	100
Buttons	120

C

Cameras	258, 308-310
Camisole	50
Caps	44-45, 97
Carhartt	39
Casco	328
Cases	228
Casual Footwear	165-168, 172-173
Celestron	312
Class A Uniforms	84-91
Accessories	95, 96
Belts	41
Blazers	92
Epaulets	95
Gloves	95
Mocks	94
Pants	84-91
Shirts	84-91
Shirt Stays	95
Skirts	92
Sweaters	94, 95
Ties	96
Turtlenecks	94
Class B Uniforms	76-81
BDUs	76
Belts	40
Pants	76-83
Shirts	76-83
Tactical Duty Uniforms	80
Tactical Response Uniforms	78, 79
Class C/Casual	6-61
Athletic	46-55
Danner	40
Boxers	47-49, 55
Compression Apparel	47-51
Concealment Shirts	24
Pants	25-40, 52
Polos	6-18, 20
Shirts	6-25, 46-61
Shorts	26-27, 46, 47, 50-55
T-Shirts	56-61
Workwear	38-39
Champion	53
Chain Handcuffs	318-319
Citation Organizers	229
Clipboards	229
Code 3	267, 269, 270, 271, 275
Coast	
Flashlights	193, 203
Knives	214, 216
Collar Brass	108
CoolCop	352
Combat Shirts	77, 78, 79, 81
Communications	218-219
Compression Apparel	47, 48, 55
Concealable Armor	353-357
Concealment Holsters	301-304
Concealment/Holster Shirts	24
Cones	
Flashlight	208
Traffic	210
Consoles	261
Cortina	210, 211
CPR	245
Cuff Cases	282-295, 305, 321
Cuff Keys	324, 325
Customization	100-105
Button Replacement	100
Emblems	102-103
Embroidery	104-105
Epaulets	100
Eyelets/Zippers	100
Heat Press	101
Hemming	100
Namestrips	100

Quality meets value with our house brands:

DutyPro™

DYNAMED

GALLS®

Law★Pro®

QUARTERMASTER™

Pocket Flaps	100
Screen Printing	101
Striping (Trousers)	100
Custom Services	
Apparel & Uniforms	104-105
Badges	110, 111
Badge Cases, Holders, Wallets	111-113
Nameplates	106, 107
Customer Satisfaction	1-364

D

Damascus	64, 134-137, 345
DAMMITS	107
Danner	156, 157, 159, 175, 181
Dash Lights	264-265
Defense Sprays	330-333
Defense Technology	330
Defibrillator	243
DeSantis	303
Diagnostics	242-243
Dickies	
Apparel	11, 19, 20, 22, 23, 30, 38, 66
Footwear	141, 164
Digital Video Cameras	258, 308-310
Dress Footwear	162-163
Drug Tests	315
Duty Footwear	138-157
Duffle Bags	222, 223, 225
DUTY GEAR	
Accessories	306-307
Concealment Holsters	301-305
Duty Holsters	296-300
Leather & Synthetic	289-295
Nylon	282-288
DutyPro	
Apparel	85, 88
Duty Gear	283
Footwear	140
Dyna Med	230-237, 239, 245-249
Dynarex	243, 244

E

Earhugger	219
Ear Phone Connection	219, 308
Edge Eyewear	336
Edwards	92-93
Elbeco	14, 18, 44, 65, 68, 70, 73, 82, 86, 89, 91, 126, 351
Elbow Pads	344
EMS Apparel	66, 68
Emblems	102-103
Embroidery	104-105
Emergency Blankets	241
Epaulets	100
Energizer	204
Entry Tools	

**FREE
SAVE!**

Don't miss out on all the special promotions listed throughout this catalog.

Fire.....	254
Tactical.....	341
Vehicle.....	217
Evidence Collection.....	308-317
Binoculars.....	312-313
Breathalyzer.....	314
Drug Tests.....	315
Fingerprinting Supplies.....	315
Inspection Mirrors.....	317
Metal Detectors.....	316-317
Night Vision.....	311
Video Cameras.....	308-310, 311
Eyewear.....	372-373
Shooting Glasses.....	336
Sunglasses.....	336
Expandable Batons.....	326-329
Eyelets/Zippers.....	100

F

Federal Signal.....	274
Fenix.....	191, 193, 197, 198, 203
Ferno.....	246
5.11	
Apparel.....	7, 9, 14-17, 23-25, 27, 33, 34, 36, 37, 41-45, 57, 58, 65, 66, 69, 71, 80, 83, 114, 116-119, 121, 123, 124, 127, 136, 137
Bags & Organizers.....	221, 222, 224-228
Duty Gear.....	288, 306
First Response.....	232, 234
Flashlights.....	192, 195, 199, 202, 204
Footwear.....	143, 144, 149, 164, 165, 168, 171, 180, 186
Knives.....	214
Vehicle.....	263
5 Star Gear.....	284
Fingerprint Supplies.....	315
Fire-Dex.....	250, 252
Fire Rescue.....	250-257
Boots.....	252-253
Gear Bags.....	251
Gloves.....	256-257
Helmets.....	251
Hoods.....	251
Protective Apparel.....	250-253, 256
Tools & Rescue.....	254
Water Rescue.....	255
First Aid Kits & Supplies.....	230-247
First-Light USA.....	198
First Responder Kits.....	230-241

FIRST RESPONSE

Fire Bags.....	251
Fire Boots.....	252-253
Fire Helmets.....	250
Fire & Extrication Gloves.....	256-257
First Aid Supplies.....	242-245
Immobilization.....	246-247
Medical Gloves.....	248-249
Medical Kits.....	230-241
Rescue Tools.....	254-255
Turnout & Extrication.....	250
Fisher.....	316, 317
Flares (Road).....	209
Flashlights.....	188-207
Accessories.....	201
Duty Lights.....	188-191, 194-195
General Purpose.....	194, 201-203, 204-205
Headlamps.....	204, 205
Rechargeable.....	188-193, 206
Lanterns.....	205



Footwear to Take on any Terrain starting on p. 138

Safety Lights.....	206
Spot Lights.....	206
Tactical Lights.....	192-193, 195, 196-200
Weapon Lights.....	200
Flexible Handcuffs.....	323
Flying Cross.....	69, 73-75, 87, 89, 91, 94, 121, 124, 125, 350

FOOTWEAR

Accessories.....	184-187
Athletic.....	168-183
Duty.....	138-157
Specialty.....	158-167
Fox40.....	211
Fox Labs.....	331
Full-Size Lightbars.....	275

G

Galls

Apparel.....	11, 20, 26, 28-29, 38, 41, 44, 57, 66, 70, 76, 81, 94-96, 110-113, 116, 120, 122, 128, 129, 133, 134
Bags & Organizers.....	220, 221, 223, 224, 225, 227-229
Batons.....	328
Body Armor.....	356-357
Communications.....	218
Duty Gear.....	286, 291, 296, 306
First Response.....	251, 255, 257
Flashlights.....	192, 196, 198, 206, 207
Footwear.....	138-139, 162, 185, 186
ID & Commendations.....	106, 110, 111, 112, 113
Investigation & Surveillance.....	312, 316
Knives & Tools.....	214
Pepper Spray.....	331
Restraints.....	319, 320, 322, 323, 324, 325
Tactical.....	341, 342, 343, 344, 345
Traffic Safety.....	208, 209, 210, 212, 213
Vehicle.....	261, 263, 264, 265, 266, 267, 270, 271, 272, 274, 276, 277, 278, 279, 280, 281
Garmin.....	218
Garrett.....	316, 317
Gas Masks.....	342
Gear Bags.....	220-221
Gerber.....	216
Gerber Outerwear.....	120, 127, 129
Gloves	
Cut-Resistant.....	133, 134, 135
Duty.....	134-137
Dress.....	95
Fire.....	256-257
Medical.....	248-249
Tactical.....	133, 137
Traffic.....	212
GoLight.....	259
GoPro.....	310
Gould & Goodrich.....	41, 293-294, 299, 303, 304, 306, 324
GPS.....	218, 311
Gun	
Accessories.....	336-339
Cases.....	338
Lights.....	200
Locks & Racks.....	262
Safes & Cabinets.....	339

H

Haix	
First Response.....	253
Footwear.....	155, 156, 168, 181



We thank the public safety professionals who proudly model for us. Wherever your tough profession takes you, you'll find we have what you need to get through in one piece. Join over one-million men and women who trust us for all their equipment and apparel needs.

Handcuffs.....	318-323
Handcuff Cases.....	282-295, 305, 321
Handcuff Keys.....	324, 325
Hard Cases.....	228
Hatch.....	64, 95, 133, 134, 136, 137
Hats.....	44-45, 96, 97
Headlamps.....	204, 205
Headwear.....	44-45, 96, 97
Hearing Protection.....	336
Heat Press.....	101
Helmets	
Ballistic.....	347
Fire.....	251
Riot.....	344
Hero's Pride.....	100
Duty Gear.....	292
Id & Commendation.....	95, 102, 211
HexArmor.....	135, 256
Hiatt.....	319, 320
High Speed Gear.....	340, 341
Hinged Cuffs.....	320-321
Holsters	
Ankle.....	304
Belt Slide.....	301, 303
Concealment.....	301-304
Duty.....	296-300
Inside the Waistband.....	301
Paddle.....	301, 302
Pancake.....	303
Shoulder.....	304
Tactical.....	340
TASER.....	300
Thigh.....	340
Honeywell.....	253, 256
Hoodies.....	46, 47, 54, 60
Hoods	
Fire.....	251
Transport.....	323
Horace Small.....	10, 85
Hydration Systems.....	341

I

ID & Commendations.....	106-113
Badges.....	109-110
Collar Brass.....	108
Medals.....	108
Mourning Bands.....	107
Nameplates.....	106, 107
Tie Bars.....	107
Wallets & Holders.....	111-113
ID Holders & Wallets.....	111-113
Immobilization.....	246-247
Insignia Pins.....	108
Insoles.....	184
Inspection Mirrors.....	317
Inspection Cameras.....	310
Interior Lightbars.....	272
Intoximeters.....	314
Investigation & Surveillance.....	308-317
Binoculars.....	312-313
Breathalyzer.....	314
Drug Tests.....	314-315
Fingerprinting Supplies.....	315
Inspection Mirrors.....	317
Metal Detectors.....	316-317
Night Vision.....	311
Video Cameras.....	308-310
Iron Duck.....	233, 235
Inside the Waistband Holsters.....	301

J

Jackets.....	42-43, 114-132
Job Shirts.....	70-71
Jotto Desk.....	261
Jumperstarters.....	260
Justin Work FR.....	72

K

Keson.....	211
Kneepads.....	344
Knives & Tools.....	214-217
Folding.....	214-215
Rescue.....	215
Multi Purpose.....	216
Vehicle Entry.....	217
Kuhl.....	40
Kustom Signals.....	259

L

Laerdal.....	247
Lapel Pins.....	108
Laptop Computer Mounts.....	262
LandAirSea.....	311

LAW & SECURITY

Body Armor.....	346-357
Investigation & Surveillance.....	308-317
Restraints.....	318-325
Self-Defense.....	326-335
Shooting Accessories.....	336-339
Tactical/Riot.....	340-345

LawPro

Apparel.....	8, 57, 64, 84, 88, 94, 95, 97, 107-112, 114, 120, 121, 132, 134
Bags & Organizers.....	222, 224
Duty Gear.....	282, 290, 307
Footwear.....	140, 162, 163, 184, 185
ID & Commendations.....	107-112
LEA.....	308
Leatherhead Tools.....	254
Leatherman.....	216
Leg Irons.....	322
Lightbars	
Full-Size.....	275
Interior.....	272-273
Mini.....	274
Lion.....	74
Lock Boxes.....	339

M

Mace.....	331
MagLite.....	193, 194, 195, 202
Magnum.....	141, 145, 148
Magnum Medical.....	244

Marmot.....	115
Mascot.....	
Apparel.....	39, 43
Footwear.....	161, 186
Masks.....	
CPR.....	245
Gas.....	342
Max Pro.....	347, 348
Mechanix.....	136
Medals.....	108
Medical.....	230-249
ALS Kits.....	234
AED.....	243
Bags.....	235
BLS Kits.....	232-233
CPR.....	245
Diagnostic.....	242-243
First Aid Kits.....	238-241
First Aid Supplies.....	230-247
Gloves.....	248-249
Immobilization.....	246-247
Kits.....	230-247
Resuscitation.....	245
Tourniquet.....	236
Trauma Kits.....	236-237
Megaphones.....	218
Merrell.....	160-161
Meret.....	233
Metal Detectors.....	316-317
Microflex.....	248
Mil-Spec Monkey.....	61
Mini Lightbars.....	274
Mirrors (Inspection).....	317
Mocean.....	62-63
Mocks.....	94
Monadnock.....	323, 329, 333
Mourning Bands.....	107
MSA.....	342
Multi-Purpose Tools.....	216
Mustang Survival.....	255

N

Nameplates.....	106, 107
Namestrips.....	100
Neese.....	130, 132
NFPA Compliant.....	
Footwear.....	252-253
Gloves (Fire).....	256
Gloves (Medical).....	248-249
Helmets.....	250
Hoods.....	251
Turnout Gear.....	250
Uniforms.....	74, 75
Nightstick Flashlights.....	191, 202, 204, 208
Night Vision.....	311
NIK.....	315
Nike.....	
Apparel.....	46-48, 59
Footwear.....	172, 174, 185
Non-Metallic Footwear.....	145, 146, 148-151, 153, 162, 164, 168, 176, 177, 181, 183
North American Rescue.....	236

O

Oakley.....	
Apparel.....	18, 45, 61, 133
Eyewear.....	336
Ogio.....	13
Ordering Information.....	98
Original S.W.A.T.....	141, 142, 143, 148
Organizers (Vehicle).....	221, 263
Outerwear.....	114-125
ANSI Compliant.....	126-132
Bike Apparel.....	62, 64, 65
Casual.....	42-43, 114-119
Duty Outerwear.....	120-121
Fleece.....	119
Rainwear.....	129, 130, 132
Stationwear.....	71, 72
System Jackets.....	122-123, 124
Waterproof.....	115, 117, 119, 120-132
Windbreakers.....	114
Workwear.....	72

Oxfords.....	140, 155, 162-168, 170, 172, 173, 179, 183
Oximeters.....	244
Oxygen Kit.....	235

P

PACA.....	346
Paddle Holsters.....	301, 302
Pancake Holsters.....	303
Pants.....	
Bike Apparel.....	63, 64, 65
Boxers.....	48, 49, 55
Class A Uniform.....	84-91
Class B Uniform.....	76-83
Class C / Casual.....	25-40, 55
Compression.....	47, 48, 49
EMS.....	66, 68
Shorts.....	26-27, 46, 47, 50-55, 63, 64, 65
Specialty Uniform.....	92
Stationwear.....	66-69, 72-75
Workwear.....	38-39
Paulson.....	343
Parade.....	347, 348, 349, 352
Partitions.....	260
Patches.....	102-103
Patrol Duty Uniforms.....	83
Peerless.....	318, 320, 322
Pelican.....	
Bags & Organizers.....	228
Flashlights.....	191, 205
Pens.....	324, 332
Pepper Sprays.....	330-333
Perfect Fit.....	111, 112, 113
Petzl.....	205, 255
Phillips.....	243
Plano.....	235, 338
Point Blank.....	346, 350, 351, 354-355
Polo Shirts.....	7-18, 20, 62, 65
Premier Crown.....	344

PRODUCT SPOTLIGHT

Galls Tactical Pants.....	28-29
Reebok ZigKick Footwear.....	182-183
Timberland Anti-Fatigue Footwear.....	150-151
TRU-SPEC 24-7 Ascent Pants.....	35
TRU-SPEC 24-7 Performance Polo.....	13
TRU-SPEC TREK Sling Pack.....	225
ProfFeet.....	186, 187
PROPPER.....	
Apparel.....	12, 21, 23, 26, 27, 30, 32, 41, 43, 44, 56, 57, 67, 72, 76, 114, 117
Bags & Organizers.....	222, 223, 226
First Response.....	250
Footwear.....	147, 149
PROTECH.....	349
PRO-LOK.....	217
Pro-Vision.....	309
Pulse Oximeters.....	244



Our mobile website makes shopping easy anywhere, any time. Visit us @ galls.com



Q

Quarterboots.....	139-141, 143-145, 148-153, 155, 156, 160, 161, 163-166, 168-171, 174, 176-179, 181, 183
Quartermaster.....	96
QuikClot.....	236, 237
QuikLite.....	201

R

Radar.....	259
Radio.....	
Scanners.....	218
Two-Way.....	218
Rainwear.....	129, 130, 132
Range Bags.....	224, 225
Reebok.....	168, 177, 179, 183
Red Guns.....	335
Red Kap.....	9, 11, 38, 56, 116
Red Man.....	234
Restraints.....	318-325
Chain Handcuffs.....	318-319
Disposable Handcuffs.....	355
Flexible Handcuffs.....	323
Handcuff Keys.....	324, 325
Hinged Handcuffs.....	320-321
Leg Irons.....	322
Restraint Cutters.....	323
Training Handcuffs.....	322
Transport Restraints.....	322, 323, 324
Resuscitation.....	245
Riot.....	
Body Protection.....	343, 344-345
Helmets.....	344
Shields.....	343
Ringers.....	212, 257
RocketScience.....	219
Rocky.....	142, 145, 159, 163, 164, 178

S

Sabre.....	332, 333
Safariland.....	295, 296, 297, 298, 299, 30, 302, 340
Safes & Cabinets.....	339
Safetec.....	315
Safety Toe Footwear.....	141, 144-146, 148, 150, 152-153, 155, 157, 160, 161, 164, 168, 179, 183
Salomon.....	170
Schumacher.....	262
Screen Printing.....	101
Seat Organizers.....	221, 263
Second Chance.....	353
Self Defense.....	326-335
Batons.....	326-329
Sprays.....	330-333
Training.....	334-335
Setina.....	260

Shears.....	244
Shields.....	
Ballistic.....	349
CPR.....	245
Riot.....	343
Shipping Information.....	98
Shirts.....	
Bike Apparel.....	62, 65
Bras.....	47, 55
Camisole.....	50
Class A Uniforms.....	84-91
Class B Uniforms.....	76-83
Class C / Casual.....	6-25, 46-61
Combat.....	77, 78, 79, 81
Compression.....	47, 55
Concealment.....	23, 24
Dickies.....	99
Holster.....	24
Hoodies.....	46, 47, 54, 60
Job Shirts.....	70, 71
Mocks.....	94
Polos.....	7-18, 20, 62, 65
Specialty Uniforms.....	93
Stationwear.....	73-75
Sweaters.....	43, 94, 95
Tanks.....	47
T-Shirts.....	48, 52-61
Turtlenecks.....	94
Shirt Stays.....	95
Shooting Accessories.....	336-339
Cases.....	338
Hearing Protection.....	336
Safes.....	339
Sights.....	337
Targets.....	338
Unloading Stations.....	338
Shorts.....	26-27, 46, 47, 50-55, 63, 64, 65
Shoulder Holsters.....	304
Sights.....	337
Signal.....	264, 265
Signs.....	211
Silencer Kit.....	79
Simulaid.....	244
Sirchie.....	315
Sirens.....	278-279
Sirens, Speakers & Switches.....	276-281
SIZING INFORMATION.....	98-99
Skirts.....	92
Smith & Warren.....	106, 108
Smith & Wesson.....	
Flashlights.....	199
Knives.....	214, 215, 216
Restraints.....	319, 320, 322, 324
Socks.....	184-187
SOG.....	215
SoundOff.....	268, 269, 270, 273

Speakers (Vehicle).....	281
Specialty Footwear.....	158-167
Specialty Uniforms	
Blazers.....	92
Dickies.....	94
Mocks.....	50
Pants.....	92
Shirts.....	93
Skirts.....	92
Sweaters.....	94, 95
Turtlenecks.....	94
Spiewak.....	90, 119, 131
Spike-Devil.....	260
Spike Systems.....	260
Splints.....	246
Spotlights	
Handheld.....	206
Vehicle.....	259
Stab Armor.....	346
Stack-On.....	338, 339
Star Signal.....	268, 271, 272, 273, 274
Stat Gear.....	215
Stationwear.....	66-75
Gloves.....	71
Job Shirts.....	70-71
Outerwear.....	71, 72
Pants.....	66-69, 70-75
Shirts.....	72-75
Steck.....	217
Steiner.....	313, 337
Stethoscopes.....	242, 243
Stinger Spike Systems.....	260
Streamlight.....	188-190, 192, 197, 200, 202, 204, 205, 206, 207, 325
Striping (Trousers).....	100
Strong.....	111, 112
Sunglasses.....	336
Surface Mount Lights.....	266-269
SureFire.....	196, 200
Survival Armor.....	353
Sweaters.....	43, 94, 95
Switches.....	280

T

Tactical & Riot.....	340-345
Body Protection.....	343, 344-345
Elbow Pads.....	344
Entry Tools.....	341
Gas Masks.....	342
Holsters.....	340
Kneepads.....	344
Riot Helmets.....	344
Tactical Vests.....	341
Shields.....	343
Tactical Duty Uniforms.....	80
Tactical Medical Solutions.....	236
Tanks.....	47
Tactical Response Uniforms.....	78-79
Tactical Research.....	146, 175, 178
Targets.....	338
Terralux.....	201
tasc Performance.....	52
TASER Holsters.....	300
Thigh Holsters.....	340
Thermal Imagers.....	255

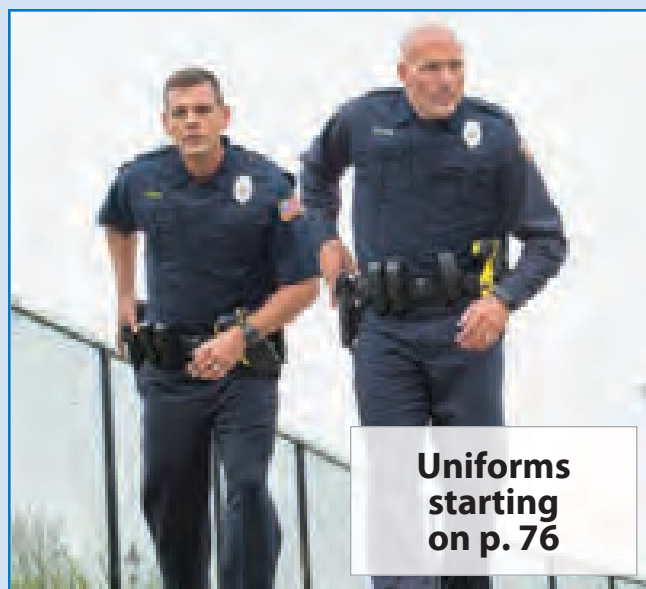

**Uniforms
starting
on p. 76**

Thorogood	
Footwear.....	153, 158, 162, 163, 176, 177
First Response.....	252, 253
Tie Bars.....	107
Ties.....	96
Timberland.....	150-151
Ticket Board Inc.....	228
Tommie Copper	
Apparel.....	50-51
Footwear.....	186

TOOLS & EQUIPMENT

Bags & Organizers.....	220-229
Communications.....	218-219
Duty Lights.....	188-191, 194-195
Flashlight Accessories.....	201
Knives & Tools.....	214-217
Safety Lights.....	206
Tactical Lights.....	192-193, 195, 196-200
Traffic Safety.....	208-213
Weapon Lights.....	200
Tools (Specialty)	
Entry Tools.....	341
Fire.....	254-255
Multi-purpose.....	216
Vehicle Entry.....	217
Tourniquet.....	236
Traffic Safety.....	208-213
Barrier Tape.....	210
Flares.....	209
Measuring Wheels.....	211
Traffic Cones.....	210
Traffic Wands.....	208
Vests.....	212-213
Training	
Bags.....	334
Suits.....	334
Blue Guns.....	335

Handcuffs.....	322
Mannequins.....	244
Red Guns.....	335
Trauma Kits.....	236-272
Transport Hoods.....	327
Transport Restraints.....	322, 323, 324
Transportation Safety Apparel.....	127, 251
TRU-SPEC.....	7, 10, 13, 22, 24, 26, 31, 35, 41, 42, 45, 56, 70, 78, 79, 117, 122, 225
Trunk Organizers.....	263
Tufloc.....	262
Turnout Gear.....	250
Turtlenecks.....	94
TurtleSkin.....	135

U, V

Uncle Mike's.....	285, 289, 297, 298
Under Armour	
Apparel.....	15, 16, 37, 45, 49, 54-55, 60, 69, 70, 79, 118
Bags & Organizers.....	223, 225
Footwear.....	154, 169, 173, 175, 176, 180, 185
Uniden.....	218
VEA.....	10, 131
VEHICLE	
Sirens, Speakers & Switches.....	276-281
Vehicle Accessories.....	258-263
Warning Lights.....	264-275
Vertx	
Apparel.....	15, 21, 27, 33, 34, 81
Bags & Organizers.....	225
Vests	
Ballistic.....	348, 353-357
Casual.....	48, 116
Spike & Stab.....	346
Tactical.....	341
Traffic.....	212-213

Video Cameras.....	258, 308-311
VIU.....	309

W

Wallets.....	112-113
Warning Lights.....	264-275
Combo Kits.....	265
Dash Lights.....	264-265
Deck Lights.....	268, 269, 273
Hideaway Lights.....	270
Interior Lightbars.....	272-273
Lightbars (Full-Size).....	275
Lightbars (Mini).....	274
Surface Mount Lights.....	266-269
Waterproof Footwear.....	141, 142, 144-146, 148-157, 158-160, 165-169, 175, 177-179, 181, 183
Weapon Cases.....	338
Weapon Lights.....	200
Whelen.....	266, 269, 270, 274, 275
Whistler.....	310
Whistles.....	211
Window Partition (Vehicle).....	260
Women's	
Class A Uniforms.....	84-91
Class B Uniforms.....	81-83
Class C / Casual.....	7, 9, 10-17, 23-25, 27, 28, 30, 31, 33-37, 39, 40, 47, 50, 52, 53, 55, 56, 58, 60
Footwear.....	139, 143-144, 146, 147, 153, 164, 167, 168, 170, 171, 172, 173, 179, 180, 181, 183
Outerwear.....	42, 115, 118
Specialty Uniforms.....	92-93
Stationwear.....	66-69, 73-75
Wolverine.....	160
Workwear.....	38-39, 72
Wrangler.....	19, 39

Z

Zak Tool	
First Response.....	254
Restraints.....	325
Zipper Footwear.....	139-153, 156-159, 176-181, 183

**Thank you for
your business!**



**Tactical Gear
to
Accomplish
the Mission
starting
on p. 340**

**Thank you for
shopping with us!**

**Duty Gear
for Carrying
Essential
Equipment
starting
on p. 282**